



PRODUCT CATALOG

**Trims & Flashing
Metal Roofing
Ventilation
Drywall Bead
Stucco & Plaster
Soffit & Fascia
Steel Framing
Gutter Protection
Safety Products**

GIBRALTAR

BUILDING ACCESSORIES DIVISION

SEMCO | DOT | APPLETON | AWARD | NORWESCO

www.gibraltarbuildingproducts.com

SC32221B

Quality Guaranteed



Southeastern Metals™ produces over 3,000 galvanized, steel and aluminum building components, specializing in metal roofing, ventilation products, trims, flashings, steel framing, corner bead and drywall accessories. Every product is precision engineered and manufactured to the highest standards to promote greater strength and durability while enhancing overall structural integrity after installation.

Since the company's foundation in 1963, Southeastern Metals™ has grown into one of the region's leading manufacturers of metal building products. In 1997, Gibraltar Industries acquired the company, uniting the quality product line of Southeastern Metals™ with the nationally respected brand name of Gibraltar. As a member of the Gibraltar Industries family, Southeastern Metals™ is part of a billion dollar network of manufacturers expanding across the globe. With the support and backing of Gibraltar, Southeastern Metals™ will remain the name you can trust for quality metal building products.

Southeastern Metals' strong focus on excellence means our customers can expect superior products and outstanding service every time they call. Our metal roofing adheres to the strictest standards, being both Miami Dade County, and Florida Building Code approved.

Southeastern Metals' corporate office and manufacturing base is headquartered on a 300,000 square-foot complex in Jacksonville, Florida allowing us to service over 1,900 locations in the southeastern United States, and beyond.

GALVANIZED STEEL

All galvanized steel products are zinc coated as specified by ASTM-A-653, Federal specification AA-S-775 E.

Caution: Do not use in contact with copper or pressure treated lumber

ALUMINUM

All aluminum products are as specified by ASTM B-209, Federal specification QQ-A-250 E.

Caution: Avoid direct contact with dissimilar metal and with concrete or mortar

FINISH

All bare 26 gauge galvanized products have a zinc coating of G-90 for corrosion resistance.

All painted products have a gloss polyester color coating over primer.

CUSTOMER SERVICE: 800-874-0335 • FAX 904-696-2536 • DELIVERIES: 7 TO 10 BUSINESS DAYS

GALVANIZED STEEL

Gauge	Thickness	Max.	Min.	Lbs./Sq. Ft.
20	0.0396	0.0356	0.0436	1.656
22	0.0336	0.0296	0.0376	1.405
24	0.0276	0.0236	0.0316	1.154
26	0.0217	0.0179	0.0247	0.907
28	0.0187	0.0157	0.0217	0.782
29	0.0172	0.0142	0.0202	0.719
30	0.0157	0.0127	0.0187	0.657
ST	0.0120	0.0118	0.0125	0.507
HT	0.0100	0.0098	0.0115	0.408

ALUMINUM

Gauge	Thickness	Max.	Min.	Lbs./Sq. Ft.
20	0.0320	0.0305	0.0365	0.451
22	0.0253	0.0224	0.0284	0.352
24	0.0201	0.0173	0.0234	0.282
26	0.0159	0.0123	0.0183	0.224
28	0.0126	0.0119	0.0132	0.177
29	0.0113	0.0112	0.0122	0.159
30	0.0100	0.0095	0.0115	0.141
ST	0.0145	0.0140	0.0180	0.208
EC	0.0085	0.0078	0.0085	0.123

METAL ROOFING

Corrugated	3
5V Crimp	3
PBR Panel	4
R Panel	4
SM-Rib	5
Sem-Lok	5
Skylight Panels	5
Metal Roofing Trims & Flashing	6

TRIMS & FLASHINGS

Angle Flashing	8
Apron/Dormer Flashing	9
Bullet Boot	9
Roof Edge	10
Eave Drip	11
Formed Valley	12
Ridge Roll	12
Water Diverter	12
Stucco Flashing	13
Z Flashing	13
Step Flashing	14
Flat Sheets	14
Roll Valley	15

VENTILATION

Gooseneck Vent	16
Weather Vent™	16
Total JACK™	16
Universal Ridge Vent	16

GUTTER PROTECTION

Clean Mesh®	17
Screen Mesh®	17
Gutter Helmet®	17

DRYWALL CORNER BEAD PRODUCTS

J Bead	18
L Bead	18
Corner Bead	18
Bullnose Corner Bead	18
Arched Corner Bead	18

CONSTRUCTION HARDWARE

H-Molding	19
Insulation Support Wire	19
Mobile Home Skirting	19
Termite Shield	19

STUCCO AND PLASTER PRODUCTS

Casing Bead	20
Outside Corner Bead	20
Inside Corner Bead	20
Vinyl Corner Bead	20

STEEL FRAMING

Diamond Steel Framing Stud	21
Diamond Steel Framing Track	21
Furring Channel	21

SAFETY EQUIPMENT

Rooftop Safety Kit	22
Roof Anchors	22
Shock Absorbing Lanyard	22
Universal Fit Harness	22
Vertical Lifeline	22

INDEX	23
-------------	----



Corrugated exposed fastener roofing panel. 21-1/2 inch width roofing coverage. 24 inch width siding coverage.
Applications: Residential, Agricultural, Architectural, Light Commercial, Industrial

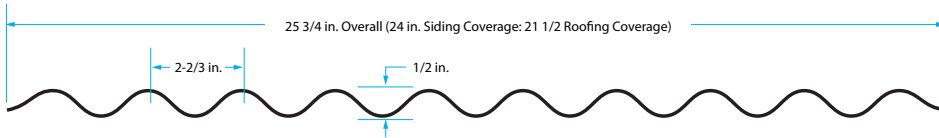

Code Approvals

UL Listing Directory #R20735

UL Fire Resistant Directory #R20735

Florida Building #FL-11175-R1

For the most recent code approval numbers, contact Southeastern Metals' Technical Department or refer to the appropriate code agency.



Underwriters Laboratories



 Regal White <small>24 gauge only</small>	 Barn Red	 Bone White	 Burnished Slate
 Charcoal Gray	 Cocoa Brown	 Forest Green	 Hawaiian Blue
 Light Stone	 Mocha Tan	 Old Town Gray	 Reflective White

NOTE: Colors shown are for reference only. Actual metal color samples are available upon request.

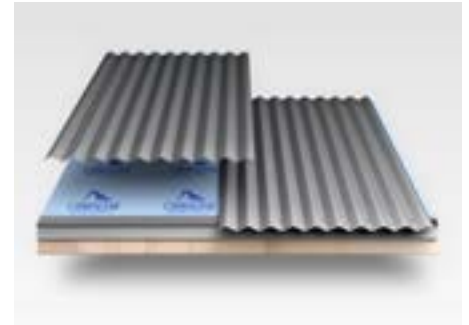

Corrugated Galvanized Steel Panels

Size	Utility	29 Ga.	26 Ga.
6 ft.	13511	-	-
8 ft.	13513	13478	13463
10 ft.	13504	-	13458
12 ft.	13506	13474	13459

G90, conforming to ASTM A446

5V Crimp exposed fastener roofing panel. 24 inch width coverage. Applications: Residential, Agricultural, Architectural, Light Commercial, Industrial

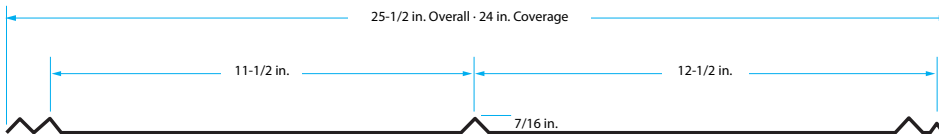

Code Approvals

UL Fire Resistant Directory #R20735

Miami Dade NOA #: 11-0714.08

Florida Building #FL-11175

1. For the most recent code approval numbers, contact Southeastern Metals' Technical Department or refer to the appropriate code agency.

Testing Data & Specifications

Accelerated testing 2000 hours - ASTM G23

Salt Spray testing 1000 hours - ASTM B117

Fire Testing - ASTM E108 or UL 790

Wind Driven Rain - TAS 100



 Regal White <small>24 gauge only</small>	 Barn Red	 Bone White	 Burnished Slate	 Charcoal Gray	 Cocoa Brown
 Forest Green	 Hawaiian Blue	 Light Stone	 Mocha Tan	 Old Town Gray	 Reflective White

G90, conforming to ASTM A446

NOTE: Colors shown are for reference only. Actual metal color samples are available upon request.

PBR Panel exposed fastener roofing panel. 36 inch width coverage. Applications: Residential, Agricultural, Architectural, Light Commercial, Industrial

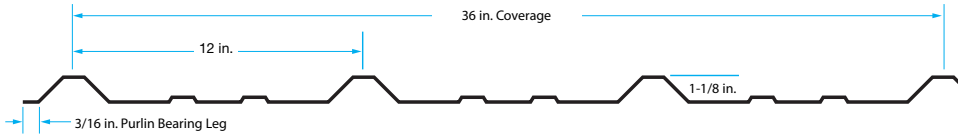

Code Approvals

UL Fire Resistant Directory #R20735
Florida Building #FL-11175

1. For the most recent code approval numbers, contact Southeastern Metals' Technical Department or refer to the appropriate code agency.

Testing Data & Specifications

Accelerated testing 2000 hours - ASTM G23
Salt Spray testing 1000 hours - ASTM B117
Fire Testing - ASTM E108 or UL 790
Wind Driven Rain - TAS 100



PBR Panels are sold by the job pack. Contact our web-based Takeoff and Estimating Services for details.

R Panel exposed fastener siding panel. 36 inch width coverage. Applications: Residential, Agricultural, Architectural, Light Commercial, Industrial

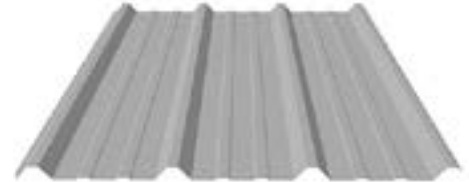
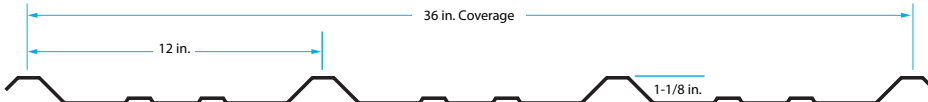

Code Approvals

UL Fire Resistant Directory #R20735
Florida Building #FL-11175

1. For the most recent code approval numbers, contact Southeastern Metals' Technical Department or refer to the appropriate code agency.

Testing Data & Specifications

Accelerated testing 2000 hours - ASTM G23
Salt Spray testing 1000 hours - ASTM B117
Fire Testing - ASTM E108 or UL 790
Wind Driven Rain - TAS 100



R Panels are sold by the job pack. Contact our web-based Takeoff and Estimating Services for details.

40 Year SEMCO Colors



NOTE: Colors shown are for reference only. Actual metal color samples are available upon request.

45 Year SEMCO Colors



SM-Rib exposed fastener roofing or siding panel. 36 inch width coverage Applications: Residential, Agricultural, Light Commercial, Industrial

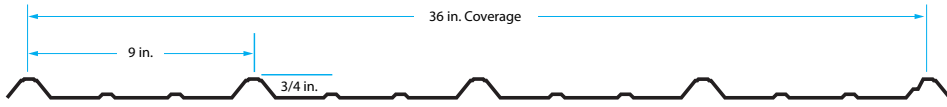

Code Approvals

UL Fire Resistant Directory #R20735
Miami Dade: N.O.A. No. 09-0630.11
Florida Building #FL-11175

Testing Data & Specifications

Accelerated testing 2000 hours - ASTM G23
Salt Spray testing 1000 hours - ASTM B117
Fire Testing - ASTM E108 or UL 790
Wind Driven Rain - TAS 100

SM-Rib Steel Panels 29 Gauge

Size	Galvanized	Galvalume
8 ft.	13560	70031
10 ft.	13542	70032
12 ft.	13544	70033
16 ft.	-	70035



1. For the most recent code approval numbers, contact Southeastern Metals' Technical Department or refer to the appropriate code agency.

Sem-Lok™ standing seam concealed fastener roofing panel. 16 inch width coverage. Applications: Residential, Agricultural, Light Commercial, Industrial

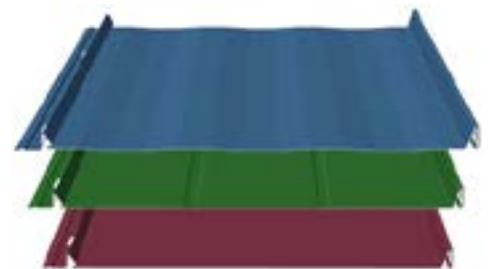
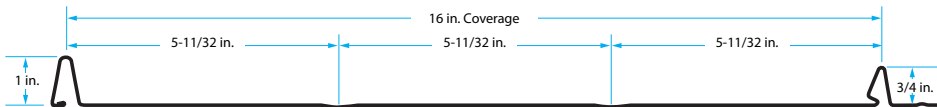

Code Approvals

UL Fire Resistant Directory #R20735
Miami Dade: N.O.A. No. 12-0229.02
Florida Building #FL-11175

Testing Data & Specifications

Accelerated testing 2000 hours - ASTM G23
Salt Spray testing 1000 hours - ASTM B117
Fire Testing - ASTM E108 or UL 790
Wind Driven Rain - TAS 100



Sem-Lok™ Panels are sold by the job pack. Available in Galvalume and SEMCO PLUS finishes, 4 – 40 ft. lengths
Contact our web-based Takeoff and Estimating Services for details.

45 Year SEMCO Plus Colors



Brick Red

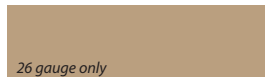

26 gauge only
Chamois Tan



Copper Penny



Hartford Green



Regal Blue



Regal White



Onyx Gray



Silver Dollar



Slate Bronze



Slate Gray

Skylight Panels

Designed to work with SM-RIB and PBR Panels. High performance glazing that stands up to punishing exterior applications. Polycarbonate Panels offer multiple advantages over traditional fiberglass panels: up to 20 times greater impact resistance, the highest light transmission rates, the lowest yellowing index, the highest load rating, and the highest resistance to wind uplift-outstanding properties confirmed in accredited laboratory testing.

Specifications

Material: Polycarbonate
Size: 3 ft. x 12 ft.
Thickness: 0.8 mm
Transparency: Clear



BD-1 Base Drip

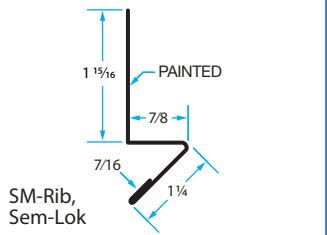

BD-2 Base Drip: 2 inch

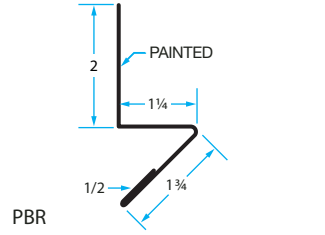

CF-1 Counter Flashing

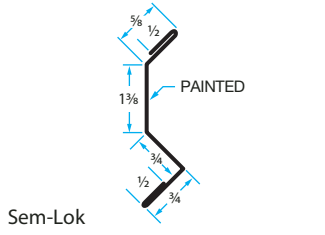

CL-1 Cleat

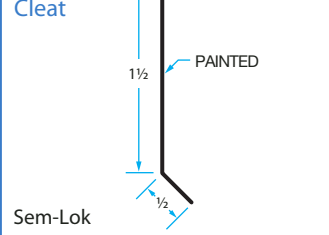

CL-2 Cleat Offset

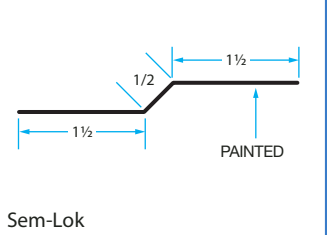

DA-1 Double Angle

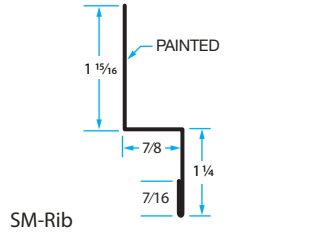

DA-2 Double Angle

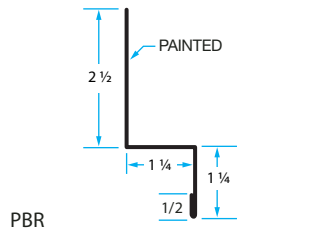

DC-1 Drip Cap

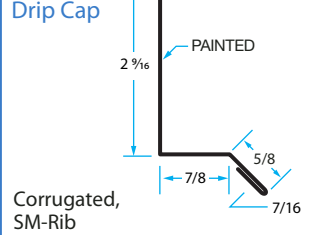

DC-2 Drip Cap

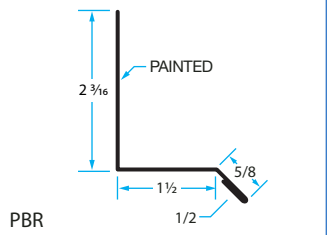

EF-1 Gable Flashing

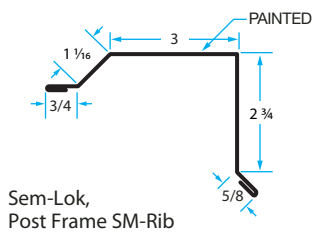

ED-2 Eave Flashing

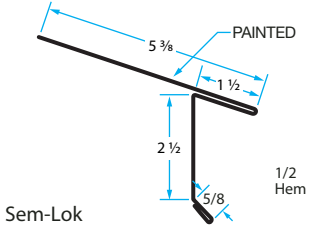

ED-2R Eave Flashing

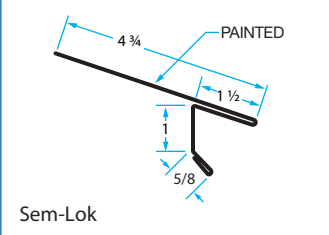

EF-3 Eave Flashing

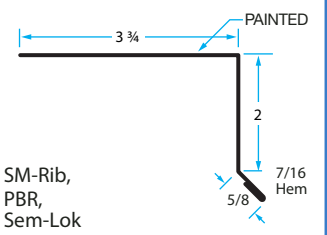

EF-5 Eave Flashing

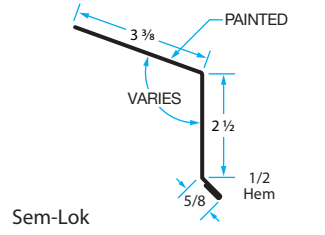

EW-1 Endwall Flashing

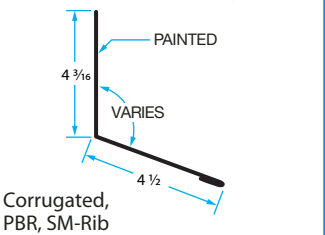

GF-1 Gambrel Flashing

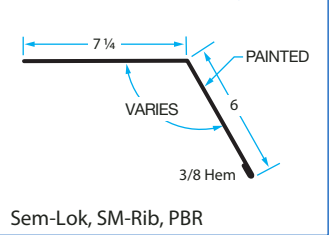

GR-2 Gable Rake & Corner

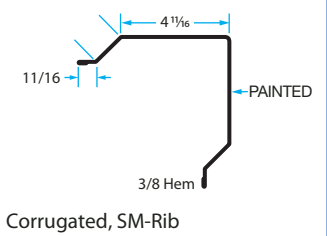

GR-5 Rake Flashing

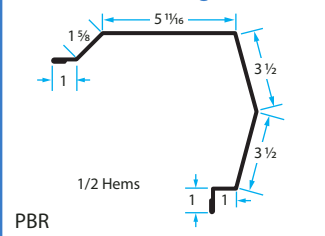

GR-6 Rake & Corner

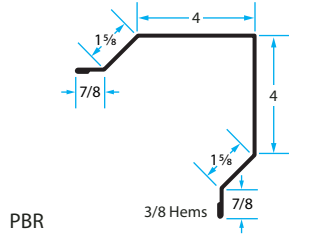

GR-7 Gable Rake

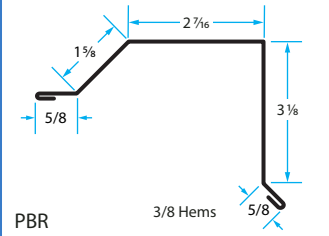

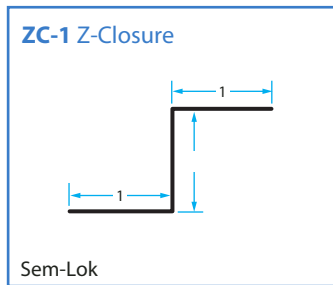
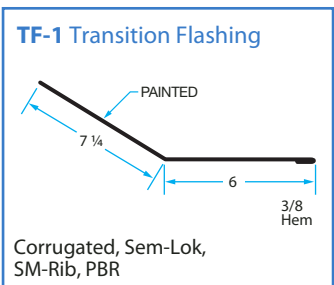
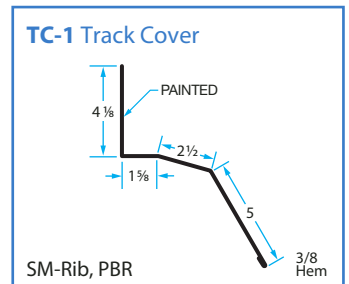
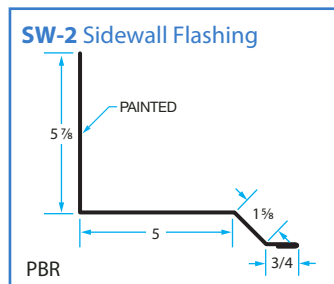
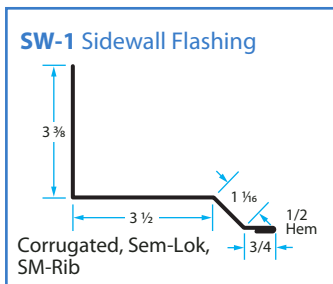
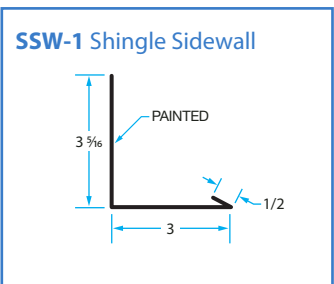
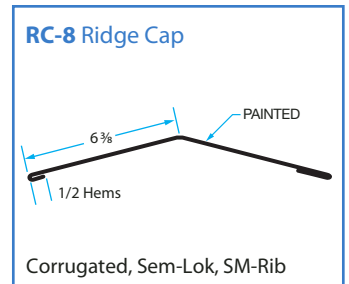
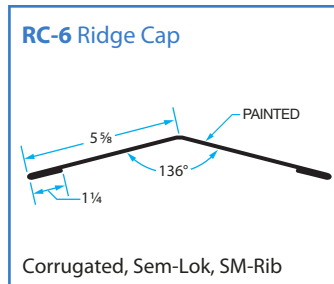
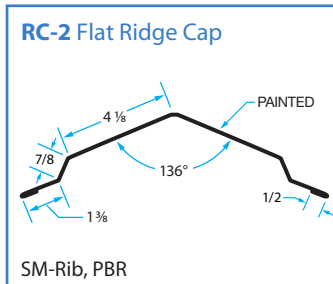
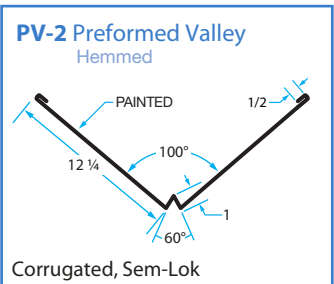
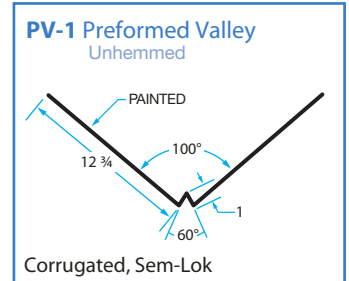
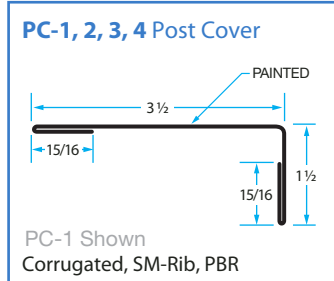
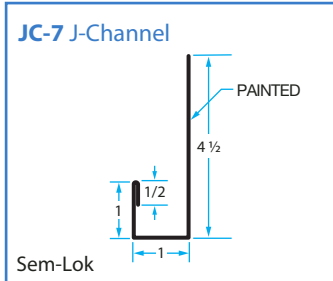
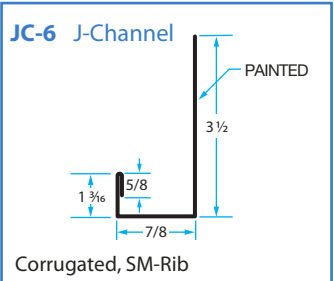
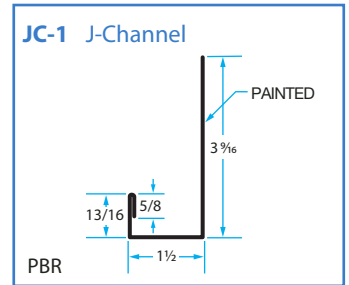
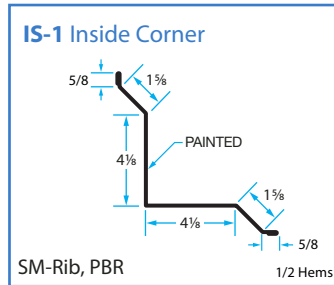
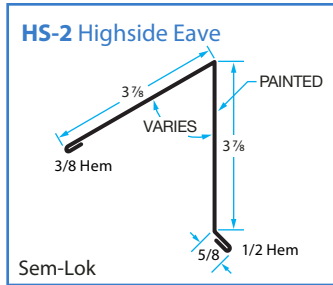
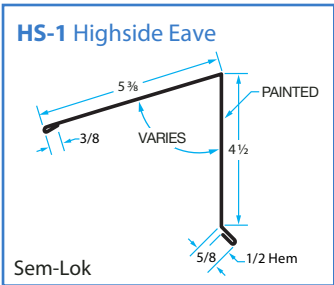

Angle Flashing protects against moisture infiltration at roof-to-wall and chimney intersections. 10 ft. Lengths · 20 Pieces per bundle

Galvanized Angle Flashing

Size - A x B	Description	ST Gauge	26 Gauge
4 in. x 4 in.	Angle Flashing ST Galvanized	10168	-
4 in. x 5 in.	Angle Flashing 26 Gauge Galvanized	-	10110
5 in. x 5 in.	Angle Flashing 26 Gauge Galvanized	-	10118
5 in. x 7 in.	Angle Flashing 26 Gauge Galvanized	-	10126
6 in. x 6 in.	Angle Flashing 26 Gauge Galvanized	-	10128

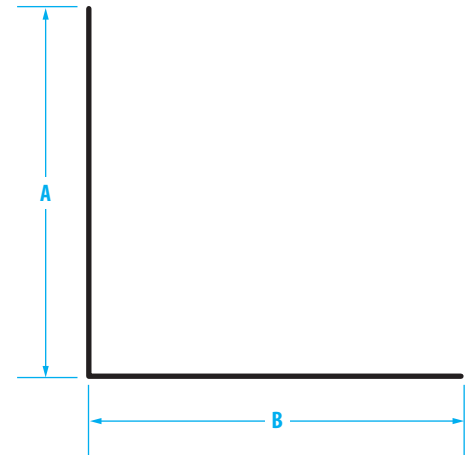

Galvalume Angle Flashing - 26 Gauge

Size - A x B	Description	Part #
4 in. x 5 in.	Angle Flashing 26 Gauge Galvalume	23167
4 in. x 6 in.	Angle Flashing 26 Gauge Galvalume	23352
5 in. x 7 in.	Angle Flashing 26 Gauge Galvalume	40266

Aluminum Angle Flashing

Size - A x B	Description	Part #
5 in. x 5 in.	0.032 Aluminum	10084

Hemmed Galvanized Angle Flashing - 1/2 in. Hem

Size - A x B	ST Gauge	HT Gauge	26 Gauge
4 in. x 3-1/2 in.	-	10177	10102
4 in. x 4 in.	10170	-	10106
5 in. x 4-1/2 in.	-	-	10122
5 in. x 5 in.	10198	-	-
6 in. x 5-1/2 in.	10212	-	10130

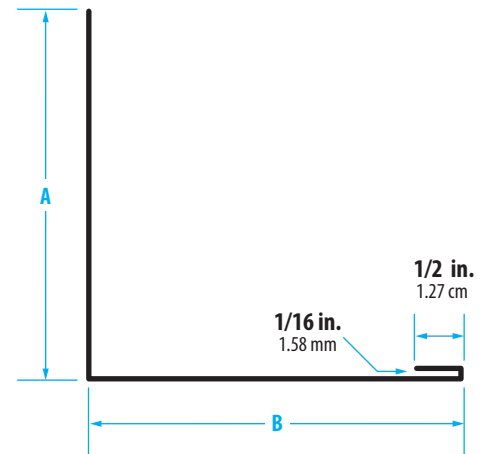

Painted Galvanized Angle Flashing - 1/2 in. Hem

Size - A x B	Description	Part #
4 in. x 4 in.	ST Gauge Galvanized - Black	50084
4 in. x 4 in.	ST Gauge Galvanized - Brown	50085
4 in. x 3-1/2 in.	ST Gauge Galvanized - Black	10125
4 in. x 9 in.	26 Gauge Galvanized - Black	10221



Painted Aluminum Angle Flashing - 1/2 in. Hem

Size - A x B	Description	Part #
5 in. x 4-1/2 in.	0.025 Aluminum - Weathered Wood	10205

Apron/Dormer Flashing Protects roofing from water damage at Roof-to-Wall connections and dormers. 10 ft. Lengths - 20 Pieces per bundle

Apron/Dormer Flashing - Mill Finish

Description	Part #
4-5/16 in. x 2-3/4 in. - ST Gauge - 7 1/2	11905
4-5/16 in. x 2-3/4 in. - 26 Gauge - 7 1/2	11889
4-5/16 in. x 3-1/4 in. - ST Gauge - 8	10866

Apron/Dormer Flashing - Painted

Description	Part #
4-5/16 in. x 4-1/4 in. - ST Gauge - Brown - 9 in.	11925
4-5/16 in. x 4-1/4 in. - ST Gauge - Black - 9 in.	98261

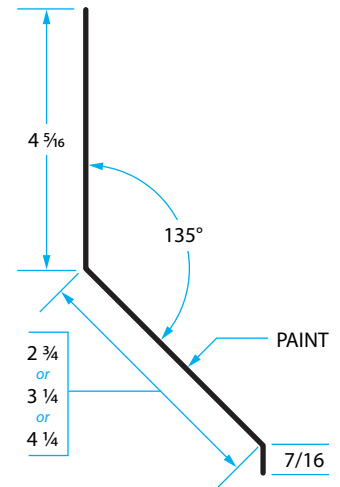

Bullet Boot is a one piece flexible rubber flashing that installs directly over standard PVC vent pipes.

Size	Black	Brown	White	Gray	Weathered Wood	QTY
1 1/2 in.	23221	23220	23222	23223	23236	16
2 in.	23225	23224	23226	23227	23237	16
3 in.	23229	23228	23230	23231	23238	16
4 in.	23233	23232	-	-	23239	8



Roof Edge Applied to the eave and rake to direct water away from the structure. 10 ft. Lengths · 10 Pieces per bundle

Galvanized Roof Edge

Known As	SEMCO's Description	26 Gauge	ST Gauge	HT Gauge	Pieces/Carton	Cartons/Pallet
1-1/2 in. x 1-1/2 in.	Roof Edge 3 in x 1-1/2 in F	-	15531	15539	25	1250
2 in x 2 in.	Roof Edge 4 in x 2 in F	15431	15541-	-	25	500
2-1/2 in. x 2-1/2 in.	Roof Edge 5 in x 2-1/2 in F	15453	-	-	25	500
3 in x 2 in	Roof Edge 5 in x 2 in F	50021	-	-	25	500
3 in x 3 in	Roof Edge 6 in x 3 in F	15455	15553	-	25	500
4 in x 2 in	Roof Edge 6 in x 2 in F	15459	15555	-	25	500
4 in x 4 in	Roof Edge 8 in x 4 in F	-	15562	-	25	500

Description	"A"	"B"
3 in x 1-1/2 in F	1-1/4 in	1-1/2 in
4 in x 2 in F	1-3/4 in	2 in
5 in x 2-1/2 in F	2-1/4 in	2-1/2 in
5 in x 2 in F	2-3/4 in	2 in
6 in x 3 in F	2-3/4 in	3 in
6 in x 2 in F	3-3/4 in	2 in
8 in x 4 in F	3-3/4 in	4 in
4-1/2 in x 2-1/2 in F	1-5/8 in	2-1/2 in

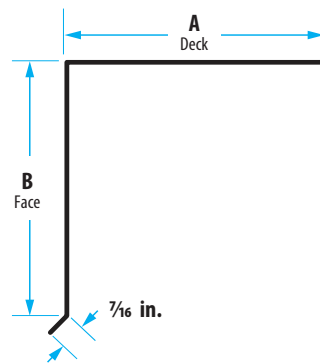

Galvalume Roof Edge

Known As	SEMCO's Description		Pieces/Carton	Cartons/Pallet
2 in x 2 in 26 Gauge	Roof Edge GM 26 4 in x 2 in F	15439	25	500
3 in x 3 in 26 Gauge	Roof Edge GM 26 6 in x 3 in F	15463	25	500
4 in x 4 in 24 Gauge	Roof Edge GM 24 8 in x 4 in F	15472	10	200

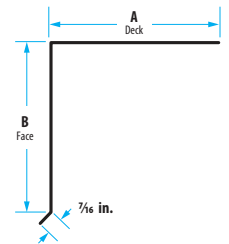

Painted Galvanized Roof Edge

Known As	SEMCO's Description	White	Brown	Black	Pcs/Ctn	Ctn/Pal
2 in x 2 in ST Gauge Galvanized	Roof Edge GZ ST 4 in x 2 in F	15587	-	-	25	500
2 in x 2 in 26 Gauge Galvanized	Roof Edge GZ 26 4 in x 2 in F	15591	50050	-	25	500
2 in x 2-1/2 in 26 Gauge Galvanized	Roof Edge GZ 26 4-1/2 in x 2-1/2 in F	15589	-	-	25	500
3 in x 3 in ST Gauge Galvanized	Roof Edge GZ ST 6 in x 3 in F	15593	-	-	25	500
3 in x 3 in 26 Gauge Galvanized	Roof Edge GZ 26 6 in x 3 in F	155595	15507	15505	25	500
4 in x 2 in ST Gauge Galvanized	Roof Edge GZ ST 6 in x 2 in F	99019	-	-	25	500
3 in x 3 in .025 Aluminum	Roof Edge AL .025 6 in x 3 in F	50058	-	-	25	500

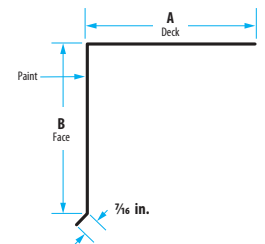

Known As	SEMCO's Description	White	Brown	Black	Pcs/Ctn	Ctn/Pal
4 in x 2 in ST Gauge Galvanized	Roof Edge GZ ST 6 in x 2 in F	50076	50074	50075	25	500
4 in x 2 in .017 Aluminum	Roof Edge AL .017 6 in x 2 in F	50071	50073	50072	25	700

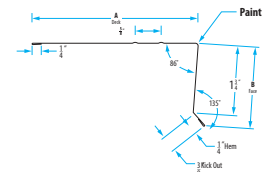

Eave Drip Applied to the eave and rake to support shingles and direct water away from the structure. 10 ft. Lengths - 10 Pieces per bundle

Galvanized Eave Drip

Size: A x B	26 Gauge	ST Gauge	HT Gauge
1-1/2 in. x 1 in. with 1/2 in. OH	-	-	11330
1-5/8 in. x 1-1/4 in.	-	11316	18612
1-3/4 in. x 1-1/8 in.	-	11324	11322
1-11/16 in. x 1-1/4 in.	11020	-	-
2 in. x 1-1/2 in.	-	11340	-
2-1/16 in. x 1-1/2 in.	11040	-	-
2 in. x 2-1/2 in.	-	11352	-
2-3/4 in. x 1-3/4 in.	-	11356	-
2-13/16 in. x 1-3/4 in.	11056	-	-
2-1/16 in. x 2-1/2 in.	11048	-	-
3-3/8 in. x 1-1/8 in.	-	11358	-

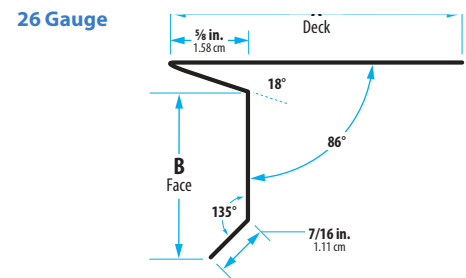
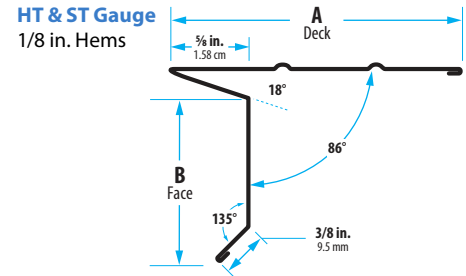

Painted Galvanized Eave Drip - ST Gauge

Size: A x B	Black	Brown	W'Wood	White
1-5/8 in. x 1-1/4 in.	11256	11220	-	11419
1-3/4 in. x 1-1/8 in.	-	-	-	11430
2 in. x 1-1/4 in.	-	-	11259	-
2 in. x 1-1/2 in.	-	-	-	11436
2-3/4 in. x 1-3/4 in.	-	11240	11261	11448
3-3/8 in. x 1-1/8 in.	11266	11238	-	11446
5 in x 1-1/2 in	11231	11230	-	-

Painted Galvanized Eave Drip - 26 Gauge

Size: A x B	Black	Beige	Brown	Gray	Green	White
1-11/16 in. x 1-1/4 in.	-	-	-	-	-	11426
2-1/16 in. x 1-1/2 in.	-	-	11232	-	-	11442
2-1/16 in. x 2-1/2 in.	11264	11214	11244	11290	11068	11454
2-13/16 in. x 1-3/4 in.	-	-	-	-	-	11054
3-1/16 in. x 1-1/2 in.	-	99489	11050	-	-	11052

Galvalume Eave Drip - 26 Gauge

Size: A x B	Mill	-	-	-	-
2-1/16 in. x 2-1/2 in.	11062	-	-	-	-



Aluminum Eave Drip - ST Gauge

Size: A x B	Mill	Black	Brown	Clay	White	Weatherwood
1-1/2 in. x 1 in.	11294	-	11168	11274	11368	-
1-5/8 in. x 1-1/4 in.	11296	11250	11170	-	11370	-
2 in. x 1-1/2 in.	-	11889	11188	11276	11390	-
2 in. x 2-1/2 in.	-	-	-	-	11396	-
2-3/8 in. x 1-1/8 in.	-	52003	52002	-	52001	-
2-3/4 in. x 1-3/4 in.	-	11405	-	-	11402	-
3-3/8 in. x 1-1/8 in.	-	99540	99539	99054	99534	-
5 in. x 1-1/2 in.	-	-	29997	-	29998	-
6 in x 2-1/2 in.	-	-	11196	-	11398	-
8 in. X 1 in.	-	52013	52012	-	52011	52014

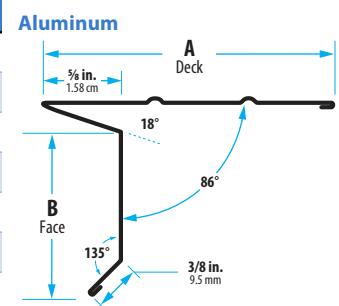

Formed Valley Used in open valley installations to protect against water infiltration. 10 ft. lengths, 10 pieces per bundle, 100 pieces per pallet

18 in. Valley

Description	Mill	Black	Brown
18 in. - Hemmed	12037	-	-

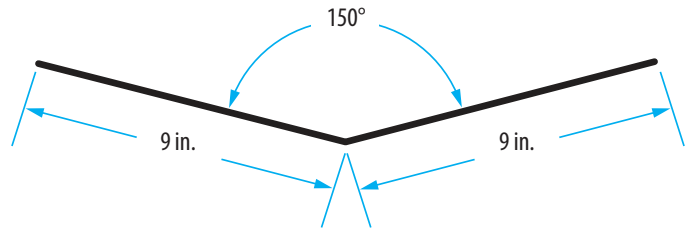

Pre-formed 18 in. W-Valley

Description	Mill	Black	Brown
18 in. - ST Gauge - Hemmed	-	14896	-
18 in. - 26 Gauge - Hemmed	14868	14897	99175

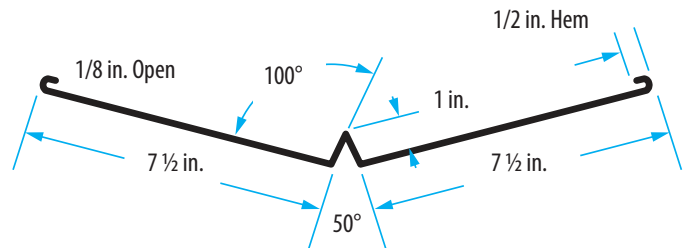

Ridge Roll Flashing for hip and ridge roof sections. For shingle or metal roofing applications. 10 ft. lengths, 10 pieces per bundle, 100 pieces per pallet

Description	Galvanized - ST Ga.
10 in. Ridge Roll	15648
12 in. Ridge Roll	15652
14 in. Ridge Roll	15654
10 in. Ridge Roll - 2-1/2 in. Corrugated	15636

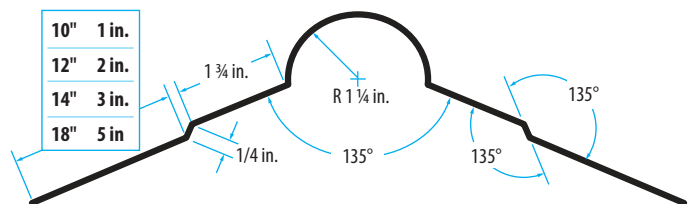

Water Diverter Directs rain water run-off away from entrances and other structures. Galvanized Steel. • 10 ft. lengths • 20 pieces per carton

Description	Mill	Black	Brown
5 in. Water Diverter - 26 Gauge - 7 1/2	17676	-	-
5 in. Water Diverter - ST Gauge - 7 1/2	17690	17684	17688

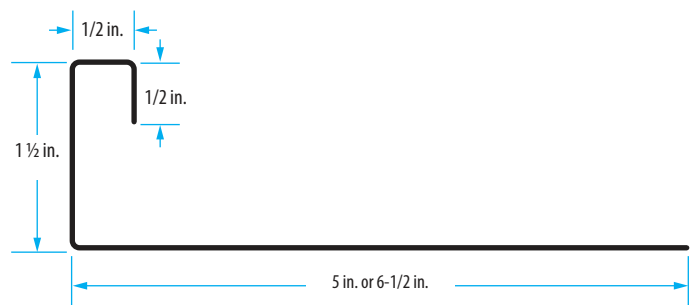

Stucco Flashing Used as a stucco stop to separate wallboard siding or stucco. 25 pieces per carton, 500 pieces per pallet

Description	26 Ga. Galvanized	26 Ga. Galvalume
Stucco Flashing	16017	99340
Stucco Flashing + Extra Bend	16019	99341

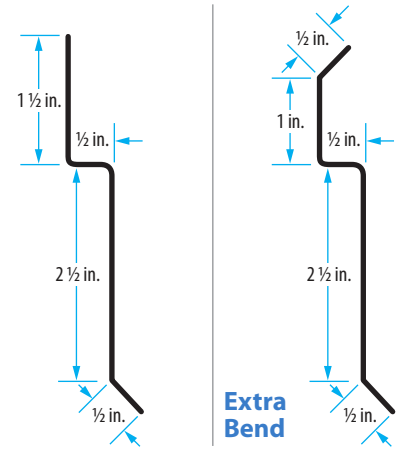

Z-Flashing Protects top edge of siding sheets from water infiltration. 10 ft. lengths • 50 pieces per bundle

Size: A x B x C	HT Galvanized	26 Ga. Galvanized	26 Ga. Galvalume
2 in. x 3/8 in. x 5/8 in.	17837	-	-
2 in. x 5/8 in. x 3/8 in.	17845	17807	17808

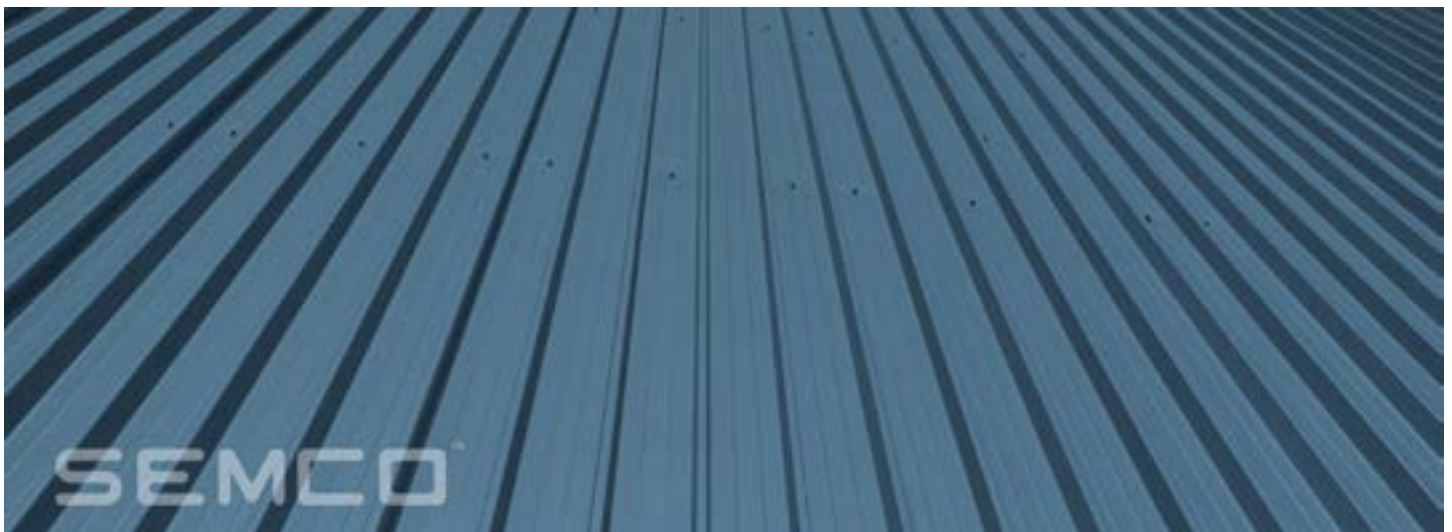
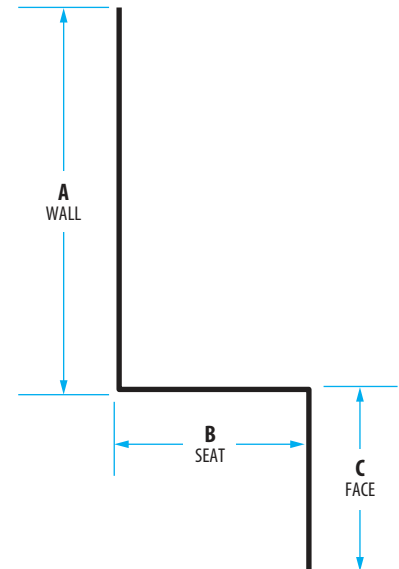

Step Flashing Step flashing is installed where shingled roofing meets the vertical wall or chimney. 1000 pieces per carton, 10,000 pieces per pallet

Aluminum Step Flashing

Description	EC Gauge	ST Gauge
Flat - 5 in. x 7 in. - Mill	-	11956
3 in. x 4 in. x 7 in. - Black	98225	-

Aluminum Step Flashing - CONTRACTOR PACKS

Description	Gavlanized	Aluminum	Qty.
3 in. x 4 in. x 7 in. - EC Gauge - Black	-	99431	10,000
4 in. x 2 in. x 8 in. - EC Gauge - Black	-	44800	10,000
4 in. x 4 in. x 8 in. - HT Gauge - Mill	99162	-	10,000

Galvanized Steel Step Flashing

Description	HT Gauge	26 Gauge
2 in. x 3 in. x 7 in. - Mill	11998	-
3 in. x 4 in. x 7 in. - Mill	12008	-
4 in. x 4 in. x 7 in. - Mill	12016	-
4 in. x 4 in. x 8 in. - Mill	12020	-

4 in. x 4 in. x 8 in. - Weathered Wood - ST Gauge	18912
---	-------

Painted Galvanized Steel Step Flashing

Description	ST Gauge	HT Gauge
4 in. x 4 in. x 8 in. - Black	11997	11993

Flat Sheet Metal is available in various thicknesses and widths and can be used as a flashing or for DIY projects 1 piece per carton, 1,000 pieces per pallet

Galvanized Steel Flat Sheets

Description	Part #
27.5 in. x 10 ft. - 26 Gauge - Mill	70020
36 in. x 4 ft. - 26 Gauge - Mill	16287
47.25 in. x 10 ft. - 26 Gauge - Black	16306
48 in. x 10 ft. - 26 Gauge - Mill	16303

Galvalume Flat Sheets

Description	Part #
27.5 in. x 10 ft. - 26 Gauge - Mill	16271
27.5 in. x 10 ft. - 24 Gauge - Mill	16251
42 in. x 10 ft. - 26 Gauge - Mill	16342
42 in. x 10 ft. - 24 Gauge - Mill	16253
48 in. x 10 ft. - 26 Gauge - Mill	16341



Roll Flashing Multi-use product for fabricating flashings and many other do-it-yourself projects. Rolls sold individually.

Galvanized Roll Flashing

Description	HT Gauge	26 Gauge
6 in. x 50 ft.	17471	-
8 in. x 50 ft.	17479	-
10 in. x 10 ft.	17404	-
10 in. x 50 ft.	17403	-
12 in. x 50 ft.	17412	-
14 in. x 10 ft.	17420	-
14 in. x 50 ft.	17419	-
16 in. x 25 ft.	-	17232
16 in. x 50 ft.	17425	17222
18 in. x 50 ft.	17431	17223
20 in. x 10 ft.	17439	-
20 in. x 25 ft.	17441	-
20 in. x 50 ft.	17438	-
24 in. x 25 ft.	17449	-
24 in. x 50 ft.	17446	-

Aluminum Roll Flashing - EC Gauge

Description	Part#
8 in. x 50 ft.	17390
10 in. x 10 ft.	17275
10 in. x 50 ft.	17208
12 in. x 50 ft.	17290
14 in. x 10 ft.	17306
14 in. x 50 ft.	17210
16 in. x 50 ft.	17318
20 in. x 10 ft.	17339
20 in. x 50 ft.	17212
24 in. x 50 ft.	17352
16 in. x 50 ft. - 0.024	20766

Painted Aluminum Roll Flashing

Description	Color	Part#
10 in. x 10 ft. - 0.013	White/Brown	17191
10 in. x 50 ft. - EC	Black	98223

Galvalume Roll Flashing - 26 Gauge

Description	Part#
16 in. x 50 ft.	60000



Gooseneck Vents Sheltered internal air dampers provides one-way air venting with damper. Often used for kitchen or bath exhaust. Self flashing flanges make for easy installation on new or existing construction.

Description	Mill	White	Brown	Black	N.F.A.	QTY
4 in. - 26 Gauge Galvanized Steel	17615	17640	17592	60027	12	12
10 in. 26 Gauge Galvanized Steel	22999	17644	17596	17605	30	6

Description	Standard	QTY	N.F.A.	Tile	QTY
4 in. - 26 Gauge Galvalume Steel	60011	12	12	60566	6
6 in. - 26 Gauge Galvalume Steel	60635	6	18	98302	4
10 in. - 26 Gauge Galvalume Steel	60010	6	30	98301	4



One-way air venting damper

Weather Vent™ Screened external wind baffle provides superior air flow with maximum weather protection. U.S. Patent Number: 7,044,852 B2

Length	Galvanized	Galvalume	White	Brown	Black	N.F.A.	QTY
2 foot - 26 Gauge	-	-	-	-	80004	52	1
4 foot - 26 Gauge	63000	60014	63003	63002	63001	105	1
6 foot - 26 Gauge	-	-	-	17594	17603	156	2
8 foot - 26 Gauge	-	-	-	-	17604	207	2

Length	26 Gauge Galvalume	N.F.A.	QTY
Tile: 4 foot - With Baffle	63130	105	1
Tile: 4 foot - Without Baffle	60094	105	1
Tile: 8 foot - Without Baffle	60028	225	2

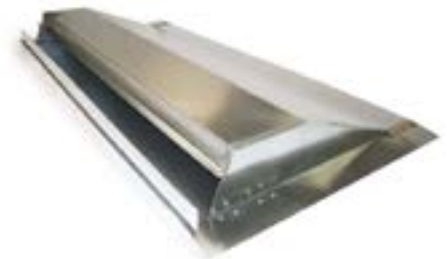

Miami Dade approved,
NOA Number 03-1008.02

Total JACK™ The only roof jack with an adjustable stack and base. Adjusts to fit most roof pitches. US Patents #8,534,013 B3 and #8,615,943 B2.

Size	Mill	Black	Brown	Weathered Wood	QTY
6 inch	JACK6GZ	JACK6BLK	JACK6BRN	JACK6WWD	7
8 inch	JACK8GZ	JACK8BLK	JACK8BRN	JACK8WWD	6

Galvanized steel in accordance to ASTM A924/A653

Base Thickness: Galvanized 0.016 in. / Painted 0.019 in.

Stack Thickness: Galvanized 0.012 in. / Painted .013 in.

Cap Thickness: Galvanized 0.012 in. / Painted 0.013 in.



Universal Ridge Vent - Aluminum Removes superheated attic air. Self-flashing. Can be installed on new or existing construction. Embossed Aluminum. 10 ft. lengths.

Description	Black	Brown	Bronze	Gray	White	QTY
10 ft. Universal Ridge Vent	84403	84405	84406	84402	84399	12
End Plug/Connector - Rubber	84426	-	-	-	-	12
End Plug/Connector - Foam	40237	-	-	-	-	24



RV-10
N.F.A.
16 sq. in./ft.

Clean Mesh® Advanced gutter protection system. Stainless steel micro mesh is effective against small debris, including pine needles, seed pods and shingle grit. Fascia mount for 5 in. or 6 in. K-Style gutters. Available in 3 and 4 ft. lengths. Patent: 8,635,811



Screen Mesh® Advanced gutter protection system. Durable aluminum construction with stainless steel micro mesh. Under shingle mount for 5 in. or 6 in. Super Gutters, Box Gutters and K-Style gutters. Available in 4 and 5 ft. lengths. Patent: 8,474,192



Gutter Helmet® The Nose Forward Design extends to the edge of the gutter, eliminating all vertical openings. Gutter Helmet's patented Textured/Ribbed Surface increases rain handling capabilities, tensile strength and is more attractive than flat panel knock-off's. Gutter Helmet® includes a PermaLife™ coating that will not chalk or fade. Engineered to last a lifetime, Gutter Helmet® installs over new or existing gutters. Only Gutter Helmet® can rightfully say you will Never Clean Your Gutters Again®!

Gutter Helmet® can only be purchased through and installed by factory-trained and certified dealers. Every installation includes a careful assessment of your roof, gutters and fascia boards as well as gutter tune-up and realignment.



J-Bead A channel-type trim that provides a neat protective edge for wallboard at windows and doors. Widely used as a terminal at intersections of wallboard and other surfaces

Description	Part #	Carton	Pallet
1/2 in. x 10 ft. - Galvanized Steel J-Bead	12839	50	2,450
1/2 in. x 10 ft. - Vinyl J-Bead	70084	50	2,400
5/8 in. x 10 ft. - Vinyl J-Bead	70083	50	2,400

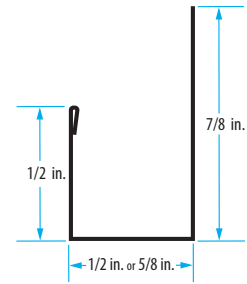

L-Bead An angle-type trim provides a finished appearance for wallboard edges at door and window openings. Hemmed edge. Nailing flange is knurled and perforated to aid compound adhesion

Description	Part #	Carton	Pallet
1/2 in. x 10 ft. - Vinyl L-Bead	70085	80	3,840
1/2 in. x 10 ft. - Galvanized Steel L-Bead	13039	50	2,400

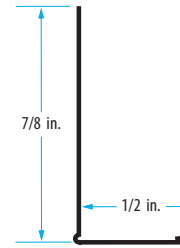

Corner Bead Strong, durable and straight reinforcement for drywall and veneer plaster corners.

Description	Part #	Carton	Pallet
1-1/4 in. x 8 ft. - Vinyl Corner Bead	10518	50	2,500
1-1/4 in. x 10 ft. - Vinyl Corner Bead	10512	50	2,500
1-1/4 in. x 8 ft. - Galvanized Steel Corner Bead	10530	63	3,087
1-1/4 in. x 9 ft. - Galvanized Steel Corner Bead	10532	56	2,744
1-1/4 in. x 10 ft. - Galvanized Steel Corner Bead	10524	50	2,450
8 ft. - Superwide Paper-Faced Corner Bead	70086	50	2,800
10 ft. - Superwide Paper-Faced Corner Bead	70087	50	2,800
10 ft. - Superwide Paper-Faced Inside Corner	70088	50	2,800
8 ft. - Big Stick Composite Corner Bead	BS3008	50	1,200
10 ft. - Big Stick Composite Corner Bead	BS30010	50	1,200
1/2 in. x 10 ft. Vinyl Zip Corner Bead	70082	50	2,400

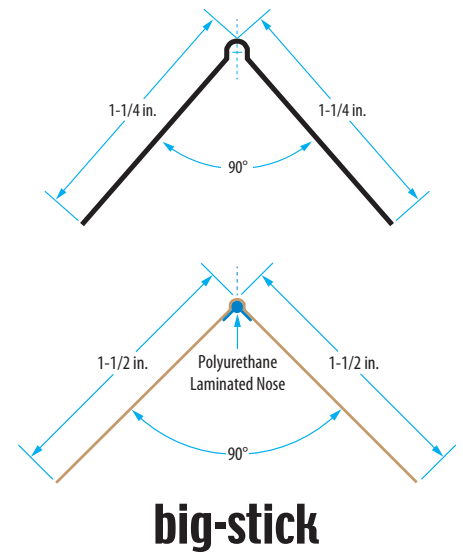

Bullnose Corner Bead Provides an architecturally attractive corner that is both durable and straight on exposed edges of wallboard.

Description	Part #	Carton	Pallet
10 ft. - Vinyl Bullnose Corner Bead	10514	35	1,750
10 ft. - Galvanized Steel Corner Bead	10505	40	1,600

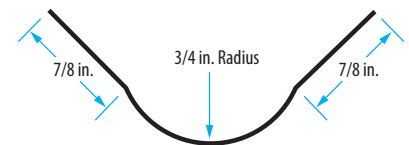

Arched Vinyl Corner Bead Pre-notched to form curves easily. Improved slots for better radius.

Description	Part #	Carton	Pallet
1-1/4 in. x 10 ft. - Arched Vinyl Corner Bead	10513	50	2500
10 ft. - Arched Vinyl Bullnose Corner Bead	70081	50	1750
10 ft. - Composite Arch Stick	AS10	25	600

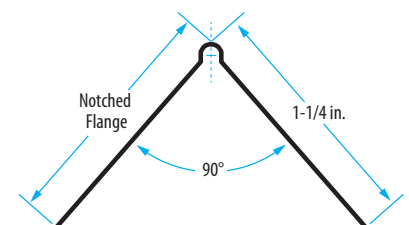

H-Moulding Used to splice butt joints of plywood soffit systems. Material: Aluminum Extrusion

Description	Part #	QTY.
3/8 in. x 12 ft. Aluminum H-Moulding	12754	50

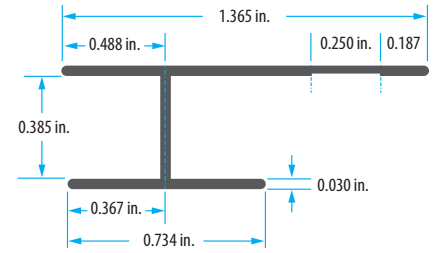

Mobile Home Skirting Embossed galvanized steel panels in a convenient size. The panels can be attached to a simple frame for mobile home skirting or utilized as a decorative wall covering.

Description	Part #	Bundle	Pallet
26 Gauge Galvanized Steel - 28 in. x 60 in.	13174	10	500



Termite Shield Provides a moisture & termite barrier for wood sill-to-concrete contact.

Description	Gauge	Part #	Bundle
4 in. x 2 in. x 10 ft. - Termite Shield	28	17049	20
8 in. x 2 in. x 10 ft. - Termite Shield	ST	17043	20

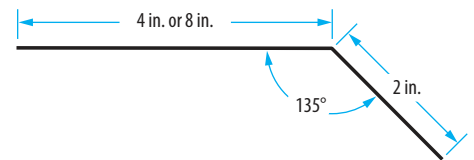

Casing Bead Creates a flush stucco stop for framed doors, windows, and other openings. A ridge of nail holes provides for easy installation.

Description	Part#	Carton	Pallet
1/2 in. x 10 ft. Galvanized Steel Casing Bead	10521	30	1,200
1/2 in. x 10 ft. Vinyl Casing Bead	10516	100	2500
3/4 in. x 10 ft. Galvanized Steel Casing Bead	10522	30	600
3/4 in. x 10 ft. Vinyl Stucco Casing Bead	10517	75	1,875

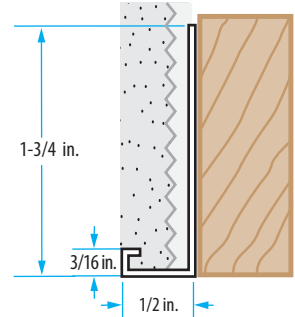

Expanded Outside Corner Bead Expanded diamond mesh wings allow for keying the plaster right up to the nose of the bead. Provides plumb reinforcement at corners.

Description	Part#	Carton	Pallet
8 ft. Galvanized Steel Outside Expansion Bead	10508	40	800
10 ft. Galvanized Steel Outside Expansion Bead	10507	30	900



Expanded Inside Corner Bead Finished edge corner lath provide reinforcement for plastered inner corners. Preshaped to 105° for a snug fit in 90° corners with wings tight against the plaster base.

Description	Part#	Carton	Pallet
3 in. x 3 in. x 8 ft. Galvanized Steel Inside Corner Bead	10509	75	1,500



Galvanized Kal-Korner Galvanized steel to protect exterior corners with veneer plastering. Flanges: 1-1/4 in.

Description	Part#	Carton	Pallet
1-1/4 in. x 1-1/4 in. x 8 ft. Galvanized Steel Corner Bead	99465	80	2,240
1-1/4 in. x 1-1/4 in. x 10 ft. Galvanized Steel Corner Bead	10510	60	1,680



Vinyl Corner Bead Reinforces exterior corners with durable and straight corners.

Description	Part#	Carton	Pallet
1-1/4 in. x 1-1/4 in. 10 ft. Vinyl Corner Bead	10515	50	1250



Diamond Steel Framing™ Stud Featuring embossed chevrons to increase strength and provide proper orientation during installation. Stiffening ribs provide additional strength and rigidity. Deep knurling allows for secure screw connections. 25 Gauge Galvanized Steel.



Description	Part#	Bundle	Pallet
1-5/8 in. x 8 ft. Diamond Steel Framing Stud	15964	10	180
1-5/8 in. x 10 ft. Diamond Steel Framing Stud	15962	10	180
2-1/2 in. x 8 ft. Diamond Steel Framing Stud	15968	10	240
2-1/2 in. x 10 ft. Diamond Steel Framing Stud	15966	10	240
3-5/8 in. x 8 ft. Diamond Steel Framing Stud	15978	10	180
3-5/8 in. x 10 ft. Diamond Steel Framing Stud	15970	10	180
3-5/8 in. x 12 ft. Diamond Steel Framing Stud	15972	10	180

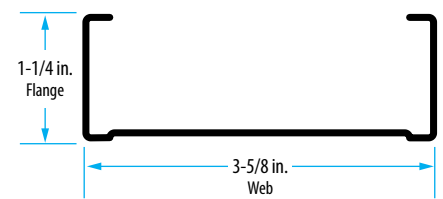
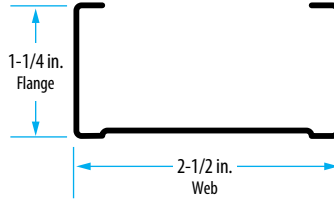
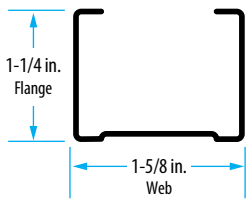

Diamond Steel Framing™ Track Track is used to anchor the partition at floor and ceiling. Channel configuration formed with unhemmed legs sized to receive the corresponding size stud. 25 Gauge Galvanized Steel.

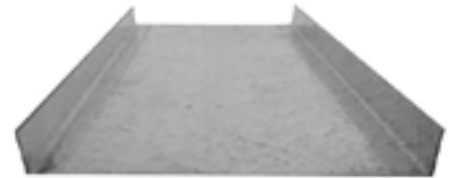

Description	Part#	Bundle	Pallet
1-5/8 in. x 10 ft. Diamond Steel Framing Track	17036	10	180
2-1/2 in. x 10 ft. Diamond Steel Framing Track	17038	10	240
3-5/8 in. x 10 ft. Diamond Steel Framing Track	17040	10	180

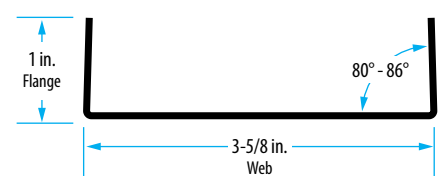
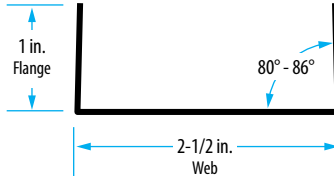
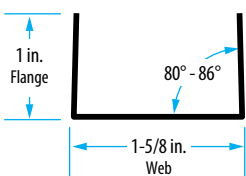

Track flanges are "toed" in to provide a friction grip on the stud.

Furring Channel also known as Hat Channel, is a corrosion-resistant framing component used to level uneven surfaces prior to applying drywall sheets to walls and ceilings. 25 Gauge Galvanized Steel.

Description	Part#	Bundle	Pallet
7/8 in. x 12 ft. High Hat Furring Channel	13194	10	500

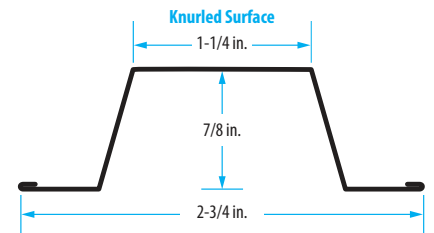

Rooftop Safety Kit Provides the basic safety tools for OSHA Compliance.

- Universal full body harness
- No tangle vertical lifeline assembly with a swivel snap hook, and integrated shock absorber
- Permanent positioning device with an 18 inch lanyard extension to help keep the device within reach
- 1 Heavy Duty tempered reusable anchor.
- 3-1/2 gallon bucket

Description	Part#	QTY
Rooftop Fall Protection Kit	00815-QC	1



Roof Anchors

Reusable Temper Roof Anchor

00455-QC
QTY: 10

Fasteners included



Permanent Double D Roof Anchor For permanent use on wood roofs

00510-QC
QTY: 10



Description	Part#	QTY
Reusable Roof Anchors - Fasteners included	00455-QC	10
Permanent Roof Anchors	00510-QC	10

Lanyard

6 ft. Shock Absorbing Lanyard

01220-QC
QTY: 6



Description	Part#	QTY
6 ft. Shock Absorbing Lanyard	01220-QC	6

Universal Fit Harness

Seraph Universal Fit Harness

11160-QC
QTY: 5



Description	Part#	QTY
Seraph Universal Harness	11160-QC	5

50 ft. Lifeline

Heavy duty poly rope resists cuts, abrasions and water absorption. Attached self locking carabiner

99422
QTY: 4



Description	Part#	QTY
50 ft. Lifeline	1320-QC	4

5V Crimp Panels	3	Metal Roof Flashings.....	6
50 ft. Lifeline	22	Mobile Home Skirting	19
Angle Flashing	8	PBR Panels	4
Apron Flashing	9	Ridge Roll	12
Arched Vinyl Corner Bead	18	Ridge Vent, Universal	17
Bullet Boot	9	Roll Flashing	15
Bullnose Corner Bead	18	Roof Anchors.....	22
Casing Bead, Stucco	20	Rooftop Safety Kit.....	22
Clean Mesh®	17	R Panels	4
Corrugated Panels	3	Screen Mesh®	17
Dormer Flashing	9	SEMCO Colors	4
Roof Edge	10	Sem-Lok™ Panels	5
Drywall Corner Bead	18	Shock Absorbing Lanyard	22
Eave Drip	11	SM-Rib Panels	5
Expanded Inside Corner Bead, Stucco	20	Standing Seam	5
Expanded Outside Corner Bead, Stucco.....	20	Steel Framing	21
Exposed Fastener	3	Step Flashing	14
Flat Sheet Metal	14	Stucco Flashing	13
Formed Valley	12	Termite Shield	19
Furring Channel	21	Total JACK™	16
Galvanized Corner Bead, Stucco.....	20	Universal Fit Harness	22
Gooseneck Vents	16	Vinyl Casing Bead, Stucco	20
Gutter Helmet®.....	17	Vinyl Corner Bead, Stucco	20
Hat Channel	21	Water Diverter	12
H-Molding	19	Weather Vent™	16
Insulation Support Wire.....	19	W-Valley	12
J-Bead, Drywall	18	Z-Flashing	13
L-Bead, Drywall	18		



Notes

GIBRALTAR BUILDING ACCESSORIES DIVISION

"Provider Of Quality Building Accessories, Built Upon Regional Expertise"

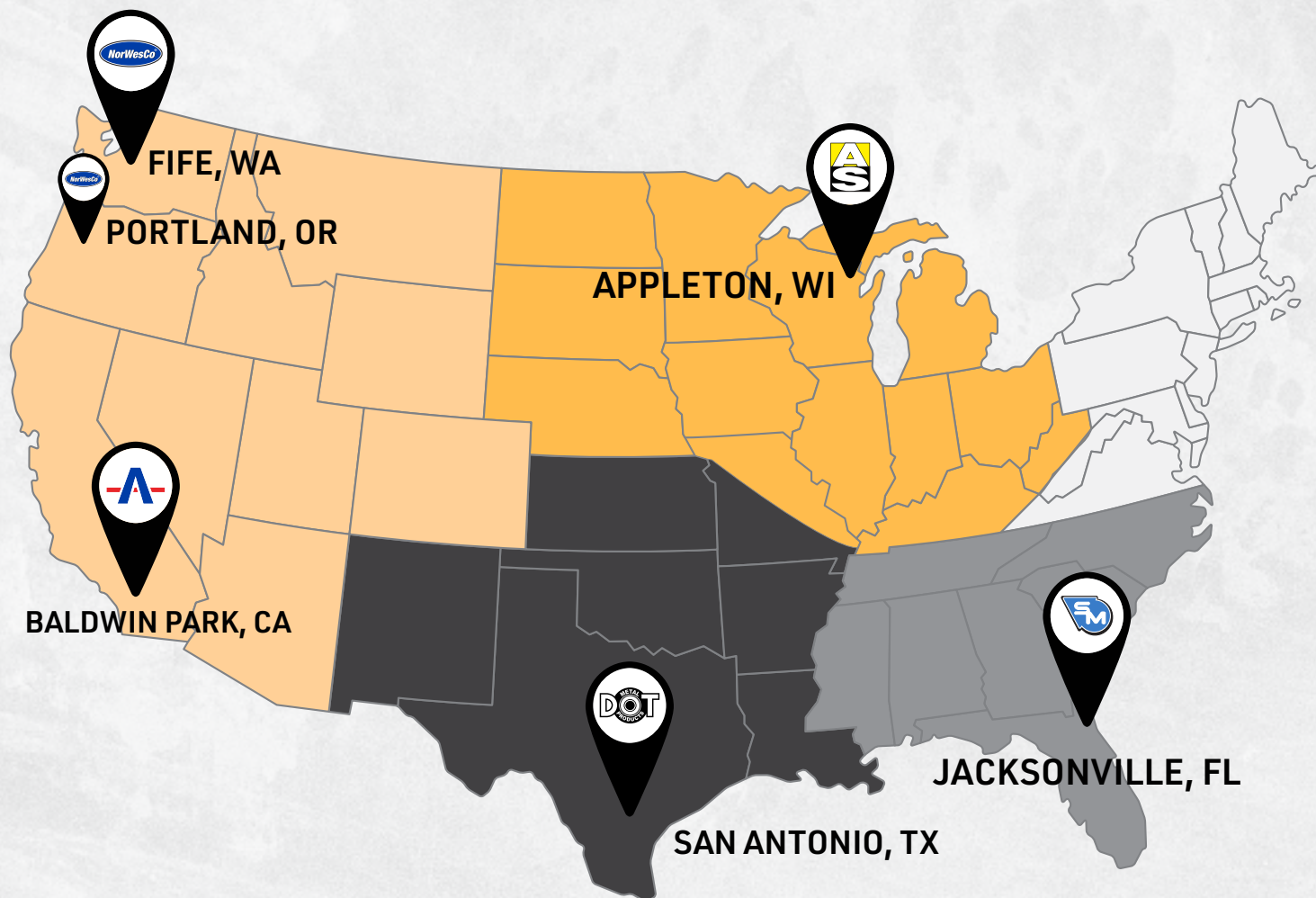

GIBRALTAR

BUILDING ACCESSORIES DIVISION

SEMCO | DOT | APPLETON | AWARD | NORWESCO

gibraltarbuildingproducts.com

Trims & Flashing
Metal Roofing
Ventilation
Drywall Bead
Stucco & Plaster
Soffit & Fascia
Steel Framing
Gutter Protection
Safety Products



GIBRALTAR

BUILDING ACCESSORIES DIVISION

SEMCO | DOT | APPLETON | AWARD | NORWESCO

www.gibraltarbuildingproducts.com