



## PRODUCT CATALOG

---

Trims & Flashing  
Metal Roofing  
Ventilation  
Drywall Bead  
Stucco & Plaster  
Soffit & Fascia  
Steel Framing  
Gutter Protection  
Safety Products

# GIBRALTAR

---

BUILDING ACCESSORIES DIVISION

SEMCO | DOT | APPLETON | AWARD | NORWESCO

[www.gibraltarbuildingproducts.com](http://www.gibraltarbuildingproducts.com)

WC32221B

# Professional Grade



**AWARD METALS**

1450 Virginia Ave., Baldwin Park, CA 91706  
Tel: 626-814-4410 · Fax: 1.626.349.3114

**NORWESCO/AWARD METALS**

3011 70th Ave. E., Fife, WA 98424-3609  
Tel: 800-426-0940 · Fax: 800-343-3063

**DELIVERIES: 7 TO 10 BUSINESS DAYS**

**TOLL FREE  
CUSTOMER SERVICE**

**800-426-0940**

AK, ID, MT, OR, UT, WA

**800-576-9810**

AZ, CA, CO, HI, NV, WY

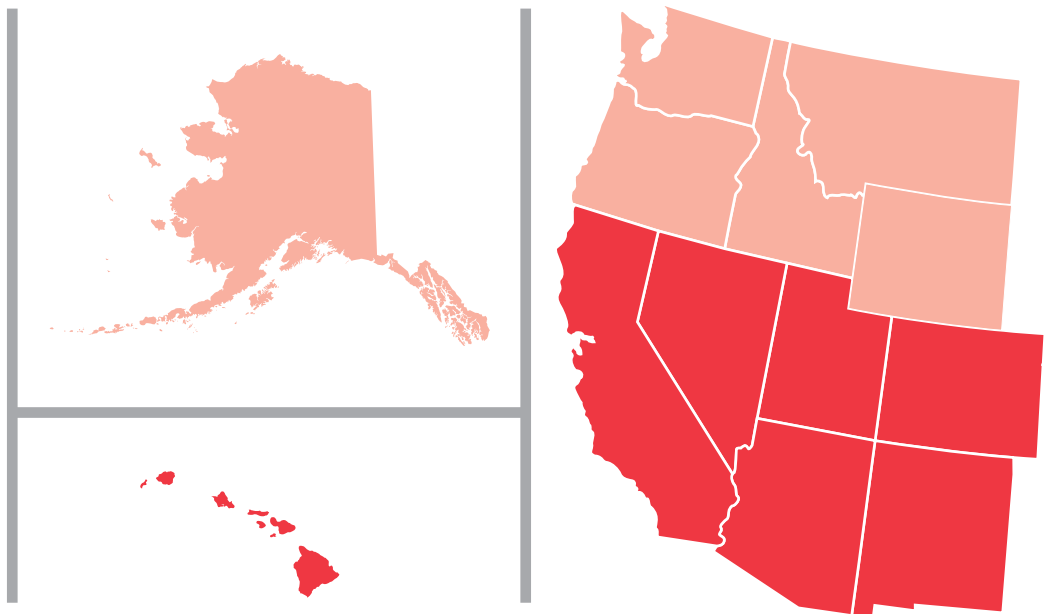

## METAL ROOFING

2 1/2 in. Corrugated Panels .....	3
PBR Panels .....	3
SM-Rib Panels.....	3
Ridge Cap .....	4
Woodfast Screws.....	4
Closure Strips.....	4
Butyl Tape .....	4
Fall Protection .....	4
Moss Control Zinc Roll .....	4
Roof Brackets .....	4

## TRIMS & FLASHINGS

### Roof Edge

Drip Edge .....	5
Painted Drip Edge .....	5
Hemmed Drip Edge .....	6
Grip Edge .....	6
3-Way Roof Edge .....	6
Fascia Cap .....	6
Gravel Stop .....	7
T-Metal .....	7
Roof Starter .....	7
Style-D Roof Edge .....	8

### Transition Flashing

Eave Riser .....	8
Tile Riser .....	8
Tile Pan .....	8
Saddle Stock .....	9
Tile Hold Down Clip .....	9
Bird Stop .....	9
Counter Flashing .....	9
L-Flashing, 90° .....	9
Painted L-Flashing, 90° .....	10
Roof to Wall .....	10
W-Valley .....	11
Z-Flashing .....	12
Siding Corners.....	13

## ROLL FLASHING

Galvanized Rolls .....	14
Aluminum Rolls .....	14
Copper Barrier .....	15
7 inch Spool Rolls .....	15

## FLAT STOCK & STEP FLASHING

Flat Stock - 3 ft. x 4 ft. ....	15
Flat Shingles .....	15
Step Flashing .....	16

## PIPE FLASHING

Adjustable Pipe Flashing .....	17
FHA Pipe Flashing .....	17
Plumber's Flashing .....	18
Scuppers .....	18
Roof Outlet .....	18
Flue Guard™ Chimney Cap.....	18

## VENTILATION

### Gable Louvers

Rectangular Gable Louvers .....	19
Bonderized Gable Louvers .....	19
Copper Gable Louvers .....	19
Round Gable Louvers .....	20
Norwesco Reversible Vent .....	20

### Rooftop Ventilation

Econo Vent .....	20
J-Vent .....	20
T-Top .....	20
Total Jack™ .....	20
Vent Adapter .....	20
Vent Cap .....	21
Code Cap .....	21
Dormer Vent .....	21
Kwik Mesh™ .....	21
Aluminum Mesh.....	21
Stem Vent .....	22
Stealth Vent® .....	22
Static Vent .....	22

### Side Wall Ventilation

Access Doors .....	24
Dryer Vent Cap .....	24
Aluminum Louvered Vent .....	24
Flat Screen Vent .....	24
Two Way Vent .....	24
Mini Louver .....	24

### Eave & Soffit Ventilation

Continuous Soffit Vent .....	25
Soffit Vent .....	25
Flush Mount Soffit Vent .....	25
Eave Vent .....	25
Vulcan Vent® .....	25

### Foundation Ventilation

Adjustable Foundation Vent .....	26
Stamped Foundation Vent .....	26
Rim Vent .....	26
Damper Doors .....	26
Foundation Vent Clips .....	26
Foam Plugs .....	26
Pour-In-Place Block Vent .....	26
Galvanized Vent Wells .....	27
Plastic Vent Wells .....	27

## CONSTRUCTION HARDWARE

Drywall Repair Squares .....	27
Drywall Clips: Insta-Back .....	27
Rain Diverter .....	27

## DRYWALL CORNER BEAD PRODUCTS

### Tape-On

90° Outside Corner .....	28
90° Inside Corner.....	28
L-Trim .....	29
Shadow Trim .....	30
Reveal Trim .....	30
J-Trim .....	30
Bullnose Outside Corner .....	30

### Paperfaced Nail-On

90° Outside Corner .....	31
90° Bullnose Outside Corner .....	31
3/4 in. Radius Kerf Bullnose .....	31

## GUTTER

Steel Fascia Gutter .....	33
Conductor Heads .....	34
Fascia Gutter Hangers .....	34
K-Style Gutter .....	35
Mitres & Connectors .....	35
End Pieces & Drop Outlets .....	36
Elbows .....	36
Touch Up Paint .....	36
Splash Shield™ .....	36
K-Style End Caps .....	37
K-Style Gutter Hangers .....	37
Strainer .....	37
Silicone Sealant .....	37
Half Round Gutters .....	38
Downspouts .....	38
Downspout Straps .....	39
Titebond® Sealant .....	39



**Corrugated** exposed fastener roofing panel. 21-1/2 inch width roofing coverage. 24 inch width siding coverage.  
Applications: Residential, Agricultural, Architectural, Light Commercial, Industrial

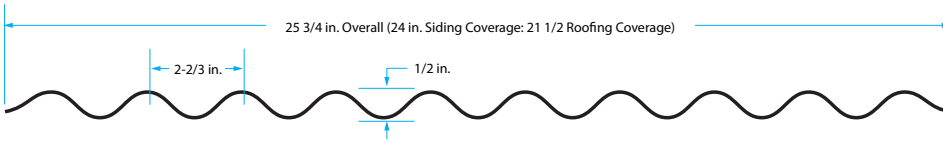

**2 1/2" Corrugated Roofing Panels** - Pack Quantity: 50

Description	29 Gauge	26 Gauge
6 ft.	CR6G-U	-
8 ft.	CR8G-U	13463
10 ft.	CR10G-U	13458
12 ft.	CR12G-U	13459
14 ft.	CR14G-U	-
16 ft.	CR16G-U	-

**Code Approvals**

UL Fire Resistant Directory #R20735  
UL Listing Directory #R20735  
Florida Building #FL-11175-R1



Underwriters  
Laboratories



Florida  
Building  
Code



G90, conforming to ASTM A446

**PBR Panel** exposed fastener roofing panel. 36 inch width coverage.  
Applications: Residential, Agricultural, Architectural, Light Commercial, Industrial

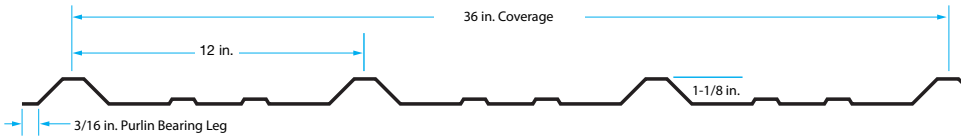

**PBR Panels** - Pack Quantity: 50

Description	26 Gauge
8 ft.	PBR8G-26
10 ft.	PBR10G-26
12 ft.	PBR12G-26

**Testing Data & Specifications**

Accelerated testing 2000 hours - ASTM G23  
Salt Spray testing 1000 hours - ASTM B117  
Fire Testing - ASTM E108 or UL 790  
Wind Driven Rain - TAS 100

**Code Approvals**

UL Fire Resistant #R20735 · Florida Building #FL-11175

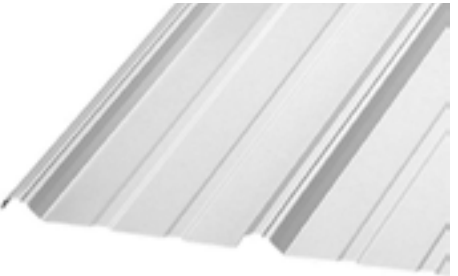

Underwriters  
Laboratories



Florida  
Building  
Code

**SM-Rib** exposed fastener siding panel. 36 inch width coverage.  
Applications: Residential, Agricultural, Light Commercial, Industrial



Size	Cotton White	Forest Green
8 ft.	SM8CW	SM8FG
10 ft.	SM10CW	SM10FG
12 ft.	SM12CW	SM12FG

29 Gauge

**Code Approvals**

UL Fire Resistant Directory #R20735  
Miami Dade: N.O.A. No. 09-0630.11  
Florida Building #FL-11175

**Testing Data & Specifications**

Accelerated testing 2000 hours - ASTM G23  
Salt Spray testing 1000 hours - ASTM B117  
Fire Testing - ASTM E108 or UL 790  
Wind Driven Rain - TAS 100



Underwriters  
Laboratories



Florida  
Building  
Code

1. For the most recent code approval numbers, contact Gibraltar Building Products Technical Department or refer to the appropriate code agency.

**Ridge Cap Flashing** for hip and ridge roof sections. For shingle or metal roof applications. 10 ft. lengths · Galvanized Steel · Pack Quantity: 10

Description	Part #
10 in. Corrugated Ridge Cap	CRC10G

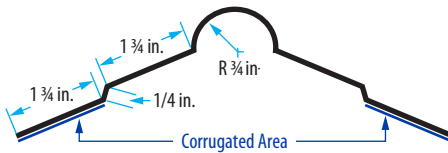

**Woodfast Screws** Galvanized #10 Hex-Head with neoprene gasket and self-piercing tip. 100 per bag · 10 bags per carton

Description	Part #
#10 x 1-1/2 in. Woodfast Screw	34166



**Closure Strips** Foam closure strips have a self-adhesive backing for ease of installation. Pack Quantity: 100

Description	Part #
Corrugated Closure	CLS24
PBR Inside	PBRCLSIN-EA
PBR Outside	PBRCLSOUT-EA
SM-Rib Inside	SMCLSIN-5
SM-Rib Outside	SMCLSOUT-5

**Butyl Tape** used to seal metal-to-metal connections. 32 rolls per carton

Description	Part #
50 ft. Butyl Tape	99415



**Heavy Duty Roof Brackets** for safety on the jobsite. 10 brackets per carton

Description	Part #
10 in. - Adjustable	HD-2500
10 in. - 45°	HD-2501
6 in. - 90°	HD-2502



**Moss Control Roll** Zinc strip to prevent moss from growing. 6 rolls per carton

Description	Part #
2-1/2 in. x 50 ft. with nails	MB50
2-1/2 in. x 50 ft. without nails	519124



**HUV Harness** Cyclone Full Body - M-L



HD-21042 · QTY: 5

**Safety Kit**

Universal Fit Harness, Temper Anchor, Shock Absorber Lifeline, Training Video - online



HD-00815-QC · QTY: 3



**Seraph Harness**

Universal Fit



HD-11160 · QTY: 5

**6 ft. Shock Absorbing Lanyard**



HD-01220 · QTY: 6

**50 ft. Lifeline**

Heavy duty poly rope resists cuts, abrasions, water absorption. Attached self locking carabineer



99422 · QTY: 4

**Roof Anchors**

Reusable Temper Roof Anchor



HD-00455 · QTY: 10

Permanent Double D Roof Anchor



HD-00510 · QTY: 10

**Bare Metal Drip Edge** 10 ft. lengths · Pack Quantities: 20

Galvanized: A x B	30 Ga.	28 Ga.	28 Gauge Bonderized	
1 in. x 2 in.	-	RE12G	1 in. x 2 in.	RE12B
1-3/8 in. x 1-3/4 in.	516764	-	1-1/2 in. x 1-1/2 in.	RE15B
1-1/2 in. x 1-1/2 in.	-	RE15G	2 in. x 3 in.	RE23B
2 in. x 3/4 in.	516765	-	<b>16 oz. Copper</b>	
2 in. x 2 in.	-	RE22G	1-1/2 in. x 2 in.	RE152CPR
2 in. x 2 in. PNW	-	516793	2 in. x 2 in.	RE22CPR
2 in. x 3 in.	-	RE23G	<b>Zinc: A x B</b>	
2 in. x 4 in.	-	RE24G	28 Ga.	26 Ga.
2 in. x 8 in.	-	RE28G	1-1/2 in. x 1-1/2 in.	RE15Z RE15Z-26
3 in. x 3 in.	-	RE33G	2 in. x 2 in.	RE22Z RE22Z-26
6 in. x 6 in.	-	RE66G	2 in. x 4 in.	RE24Z RE24Z-26

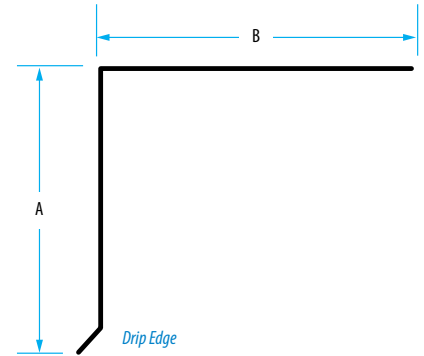

**Painted Drip Edge** 10 ft. lengths · Pack Quantities: 20

30 Gauge: A x B	Black	Dark Brown	Gray	White
1-3/8 in. x 1 in.	-	517978	-	-
1-3/8 in. x 1-3/8 in.	-	-	-	517979
1-3/8 in. x 1-3/4 in.	516564	516864	516664	516964
2 in. x 3/4 in.	-	516865	-	-
2 in. x 1-1/2 in.	-	516346	-	-
2 in. x 2 in. PNW	517776	516876	517966	516976
3 in. x 2 in.	-	-	517781	-
3 in. x 3 in.	-	-	-	516982

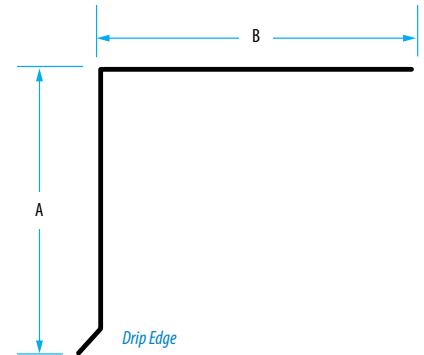

28 Gauge: A x B	Black	Brown	Charcoal	D. Brown	Gray	R. Brown	White
1 3/8 in. x 1 in.	516121	-	-	-	-	-	-
1 3/8 in. x 1 3/8 in.	-	-	-	517514	-	-	-
1-1/2 in. x 1-1/2 in.	RE15BL	RE15BR	RE15CH	RE15BRW	RE15GR	RE15BRU	RE15WH
2 in. x 1 1/8 in.	-	-	-	517426	-	-	517186
2 in. x 1-1/2 in.	-	-	-	517191	-	-	517185
2 in. x 2 in.	-	RE22BR	RE22CH	RE22BRW	-	RE22BRU	RE22WH
2 in. x 3 in.	-	RE23BR	RE23CH	RE23BRW	-	RE23BRU	RE23WH
2 in. x 4 in.	-	RE24BR	RE24CH	-	-	-	RE24WH
3 in. x 3 in.	-	RE33BR	RE33CH	RE33BRW	-	-	RE33WH
4 in. x 1-3/8 in.	-	-	-	517046	-	-	-

26 Gauge: A x B	Black	Brown	Charcoal	D. Brown	Gray	White
1-3/8 in. x 1-3/4 in.	516172	-	-	516170	516173	516171
1-1/2 in. x 1-1/2 in.	-	-	-	-	-	RE15WH-26
2 in. x 2 in.	-	RE22BR-26	RE22CH-26	-	-	RE22WH-26
2 in. x 2 in. PNW	517969	-	-	517967	517949	517229
2 in. x 4 in.	-	RE24BR-26	-	-	-	RE24WH-26
5 in. x 3 in.	517710	-	-	-	-	-

## Hemmed Roof Edge 28 Gauge · 10 ft. lengths · Pack Quantity: 10

### RE Style

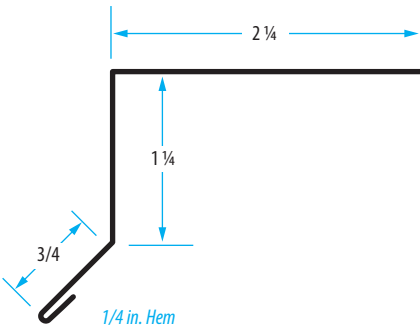

Finish	Part #
Galvanized	RE90G
Black	RE90BL
Clay	RE90CL
Royal Brown	RE90BRU
Sand	RE90SND
Tan	RE90TN
White	RE90WH

### REL Style

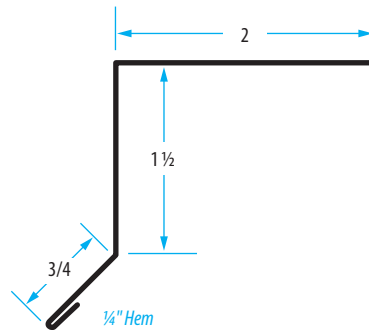

Finish	Part #
Galvanized	REL90G
Black	REL90BL
Royal Brown	REL90BRU
White	RE90WH

### Special 90

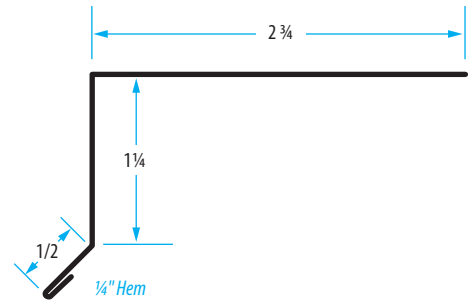

Finish	Part #
Dark Brown	516837
White	516937

## Grip Edge 28 Gauge · 10 ft. lengths · Pack Quantity: 30

Size: A x B	Galvanized	Brown	Charcoal	White
1 in. x 2 in.	GE12G	-	-	-
1-1/2 in. x 1-1/2 in.	GE15G	GE15BR	GE15CH	GE15WH
2 in. x 2 in.	GE22G	GE22BR	GE22CH	GE22WH
2 in. x 3 in.	-	-	-	GE23WH

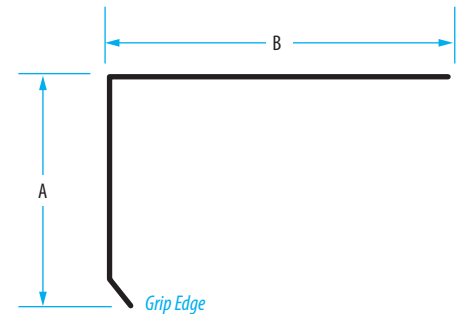

## 3-Way Roof Edge 28 Gauge · 10 ft. lengths · Pack Quantity: 10

Material	Part #
Bonderized Steel	3W4B
Brown Painted Steel	3W4BR
White Painted Steel	3W4WH

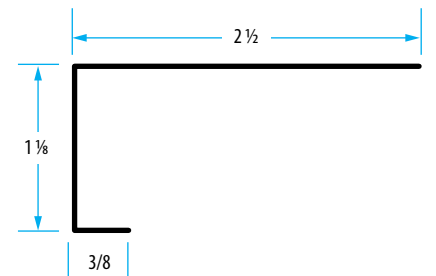

## Fascia Cap 28 Gauge · 10 ft. lengths · Pack Quantity: 10

Color	Part #
Dark Brown	FC2BRW

Protects roof edges by diverting water away from a wooden fascia board. The lower face has a drip edge; the upper face has a grip edge.

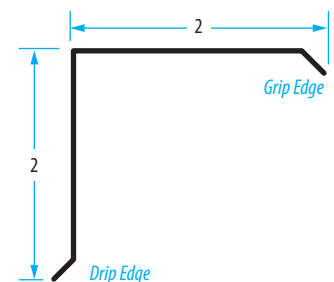

**Bare Metal Gravel Stop** 28 Gauge · 10 ft. lengths · Pack Quantity: 10

Size: A x B	Galvanized	Bonderized	Zinc
2 in. x 4 in. + 1/4" rise	-	-	CS24Z
2 in. x 4 in. + 1/2" rise	-	GS24B	-
2 1/4 in. x 2 in. + 5/8" rise	516769	-	-
3 in. x 3 in. + 1/4" rise	-	-	CS33Z
3 in. x 3 in. + 1/2" rise	GS33G	-	-
3 in. x 4 in. + 1/4" rise	CS34G	-	-
4 in. x 4 in. + 1/2" rise	-	GS44B	-

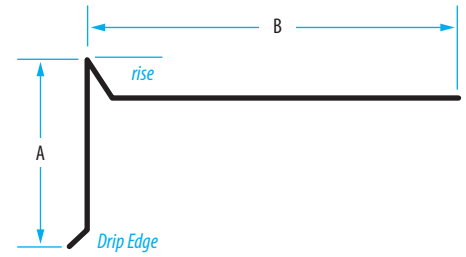

**Painted Gravel Stop** 28 Gauge · 10 ft. lengths · Pack Quantity: 10

Size: A x B	Brown	White
2 in. x 4 in. + 1/8" rise	CS2418BR	CS2418WH
2 in. x 4 in. + 1/4" rise	CS24BR	-
2-1/4 in. x 2 in. + 5/8" rise	-	517770
3 in. x 3 in. + 1/4" rise	CS33BR	-

**26 Gauge Gravel Stop** 10 ft. lengths · Pack Quantity: 10

Size: A x B	Galvanized	Zinc	Black	White
2 in. x 4 in. + 1/8" rise	CS2418G-26	-	-	CS2418WH-26
2 in. x 4 in. + 1/4" rise	-	CS24Z-26	-	-
2-1/4 in. x 2 in. + 5/8" rise	-	-	517870	-

**Grip Edge Gravel Stop** 28 Gauge · 10 ft. lengths · Pack Quantity: 10

Size: A x B	Galvanized
2 in. x 4 in. + 1/2" rise	GEGS24G
4 in. x 4 in. + 1/2" rise	GEGS44G

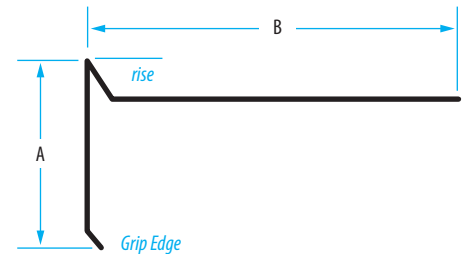

**T-Metal** 10 ft. lengths · Pack Quantity: 10

	Black	Dark Brown	Gray	White
<b>A - 26 Gauge</b>	TMETBL-26	TMETBRW-26	516228	516226
<b>A - 30 Gauge</b>	516675	516875	-	-
<b>B - 26 Gauge</b>	517203	517201	517207	517204

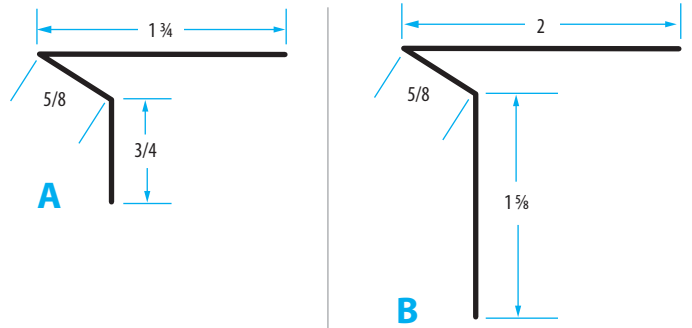

**Roof Starter #230** 10 ft. lengths · Pack Quantity: 10

Gauge	Galvanized	Stainless	Black	Dk. Brown	White
28	RSG	RSSS	516670	516860	516960
26	-	-	517132	517130	517131

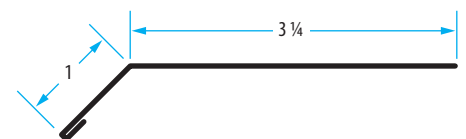



**Style-D Eave Drip** 10 ft. lengths · Pack: 25

28 Gauge - No Hem	
Galvanized	SDG
Black	SDBL
Brown	-
Dark Brown	SDBRW
Gray	SDGR
Royal Brown	SDBRU
White	SDWH

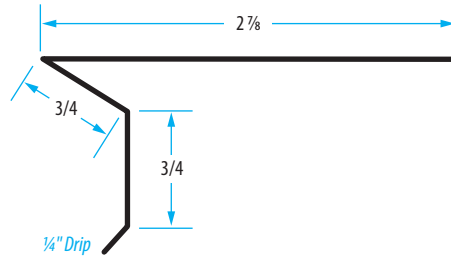

26 Gauge - No Hem	
Galvanized	-
Black	-
Brown	SDBR-26
Dark Brown	-
Gray	-
Royal Brown	-
White	SDWH-26

30 Gauge - Hemmed	
Galvanized	516763
Black	516663
Brown	-
Dark Brown	516863
Gray	517963
Royal Brown	-
White	516963

28 Gauge - Hemmed	
Galvanized	516563
Brown	-
Dark Brown	516878
Gray	516895
Royal Brown	-
White	516978

26 Gauge - Hemmed	
Galvanized	-
Black	517970
Brown	-
Dark Brown	517980
Gray	-
Royal Brown	-
White	517990

**Tile Riser** Galvanized Steel · 10 ft. lengths · Pack Quantity: 10 · 4:12 Pitch · Weep & Nail Holes

Color	28 Gauge	26 Gauge
Charcoal	3TR1.5C28	3TR1.5C26
Brown	3TR1.5BR28	3TR1.5BR26

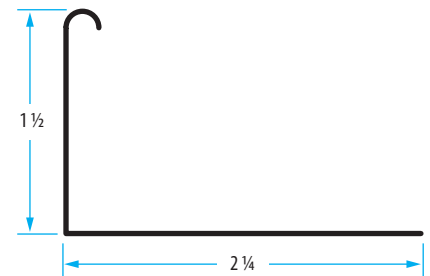

**Tile Pan** 26 Gauge Galvanized Steel  
10 ft. lengths · Pack Quantity: 10

Size: A x B x C	Galvanized
3-1/2 in. x 6 in. x 1/2 in.	TP10G-26
4 in. x 6 in. x 1 in.	TP11G-26
4 in. x 6 in. x 1 in. - 45°	TP11G-26-45
4 in. x 7 in. x 1 in.	TP12G-26
4 in. x 7 in. x 1 in. - 45°	TP12G-26-45
6 in. x 8 in. x 1 in. - 45°	TP15G-26-45
6 in. x 8 in. x 1 in. - 45°*	TP15G1R-26-45

**Tile Pan** 26 Gauge Zinc  
10 ft. lengths · Pack Quantity: 10

Size: A x B x C	Zinc
3-1/2 in. x 6 in. x 1/2 in.	TP10Z-26
4 in. x 6 in. x 1 in.	-
4 in. x 6 in. x 1 in. - 45°	-
4 in. x 7 in. x 1 in.	TP12Z-26
4 in. x 7 in. x 1 in. - 45°	TP12Z-26
6 in. x 8 in. x 1 in. - 45°	-
-	-

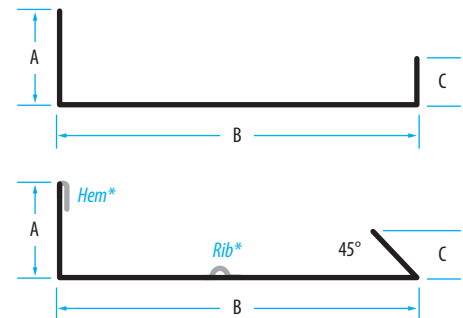

\* Hem + Rib

3-1/2 in. x 6 in. x 1/2 in. - 28 Gauge	TP10G
--	-------

**Saddle Stock** Galvanized Steel · 10 ft. lengths

Size: A x B	Galvanized	Black	Dark Brown	Gray	QTY
4 in. x 14 in. - 28 Ga.	SS414G	-	-	-	10
4 in. x 14 in. - 26 Ga.	SS414G-26	-	-	-	10
5 in. x 13 in. - 28 Ga.	-	517772	518772	-	5
5 in. x 13 in. - 26 Ga.	-	517786	517784	517787	5

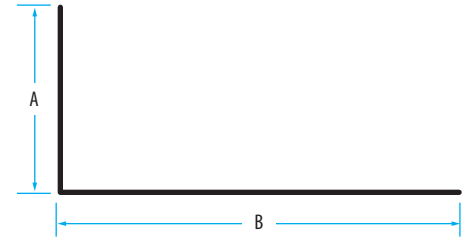

**Bird Stop** 30 Gauge · Pack Quantity: 10

	Charcoal	Red
Capistrano	3BSC30EC11	3BSR30EC
Malibu	3BSC30EM11	3BSR30EM11
Maxi Tile	-	3BSR30MXT-5
M. Mission	3BSC30MS	-
Barcelona	3BSC30LB	3BSR30LB
Espana	3BSC30LE	3BSR30LE
Villa	3BSC30MV	3BSR30MV

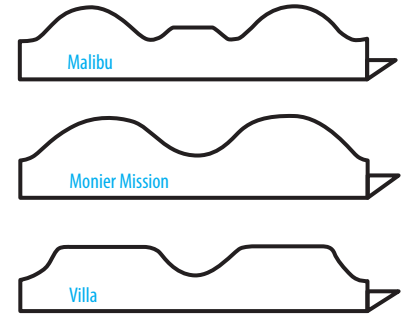
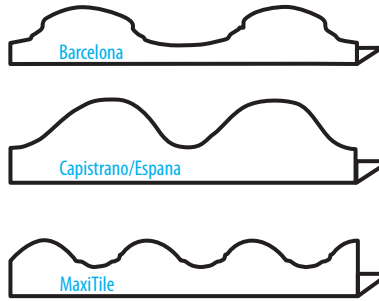

**Counter Flashing** 26 Gauge · 10 ft. lengths · Pack Quantity: 10

Size: A x B	Galvanized	Zinc
3 in. x 1/2 in.	-	3CTF.53Z26
5 in. x 1/2 in.	3CTF.53Z26	3CTF.55Z26
6 in. x 1/2 in.	-	3CTF.56Z26

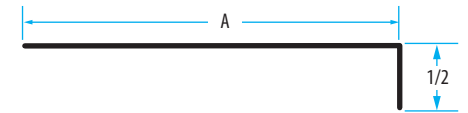

**Bare Metal L-Flashing** Pack Quantity: 20

Size: A x B	Galvanized		Bonderized		Zinc
	30 Ga.	28 Ga.	26 Ga.	28 Ga.	28 Ga.
1 in. x 1 in.	516707	-	-	-	-
1 in. x 1-1/2 in.	516702	LF115G	-	-	-
1-1/2 in. x 1-1/2 in.	516704	LF15G	-	-	-
1 in. x 2 in.	516703	LF12G	-	-	-
1 in. x 3 in.	-	516752	-	-	-
2 in. x 2 in.	-	LF22G	-	-	-
2 in. x 3 in.	-	LF23G	-	-	-
2 in. x 4 in.	-	LF24G	-	-	-
3 in. x 3 in.	-	LF33G	-	LF33B	-
3 in. x 4 in.	-	516750	-	-	-
3 in. x 5 in.	-	-	-	-	LF35Z
4 in. x 4 in.	-	LF44G	-	-	-
4 in. x 5 in.	-	LF45G	-	-	-
4 in. x 6 in.	516695	LF46G	LF46G-26	-	LF46Z
6 in. x 6 in.	-	LF66G	-	-	-

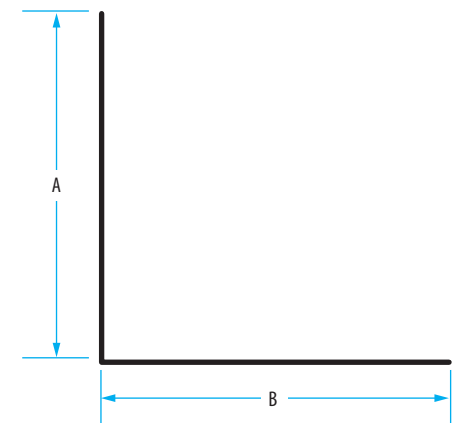

**Painted L-Flashing** Pack Quantity: 20

Size: A x B	Black		Dark Brown		White	
	30 Ga.	28 Ga.	30 Ga.	28 Ga.	30 Ga.	28 Ga.
1 in. x 1.5 in.	-	-	516802	-	516902	-
1.5 in. x 1.5 in.	-	-	516804	LF15BRW	516904	-
1 in. x 2 in.	-	-	516803	-	516903	-
1 in. x 3 in.	-	-	516852	-	516952	-
2 in. x 2 in.	-	-	516805	LF22BRW	516905	-
2 in. x 3 in.	516653	-	516853	LF23BRW	516953	-
2 in. x 4 in.	-	-	516846	-	516946	-
3 in. x 3 in.	-	-	516806	-	516906	-
3 in. x 5 in.	-	-	-	516857	-	-
4 in. x 4 in.	-	516608	-	516808	-	516908
4 in. x 6 in.	-	-	-	820406	-	LF46WH
6 in. x 6 in.	-	-	-	516809	-	-

  

Size: A x B	Dark Brown	Gray
26 Gauge L-Flashing 2 in. x 2 in.	LF22BRW-26	517220

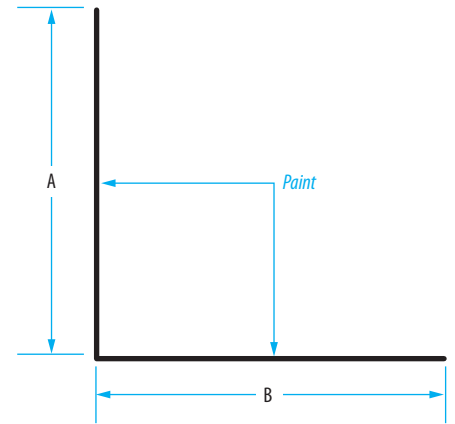

**Bare Metal Roof to Wall** 10 ft. lengths · Pack Quantity: 10

A x B	Galvanized		Bonderized	Zinc	
	28 Gauge	26 Gauge	28 Gauge	28 Gauge	26 Gauge
2 in. x 3 in.	RW23G	RW23G-26	-	-	-
2 in. x 4 in.	-	-	-	-	RW24Z-26-110
2 in. x 6 in.	RW26G	-	RW26B	-	RW26Z-26-110
3 in. x 5 in.	RW35G	-	-	RW35Z-110	-
4 in. x 4 in.	-	-	-	-	RW44Z-26-110
4 in. x 5 in.	RW45G-120*	-	-	-	-
4 in. x 6 in.	RW46G	RW46G-26	-	-	RW46Z-26-110

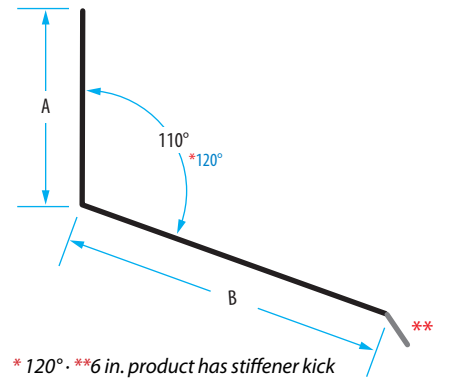

**9/12 Roof to Wall** 10 ft. lengths · Pack Quantity: 10

Description	Black	Brown
1 in. x 3 in. - 9/12 Pitch · 26 Gauge	517123	517121
3 in. x 5 in. - 9/12 Pitch · 26 Gauge	516260	516261

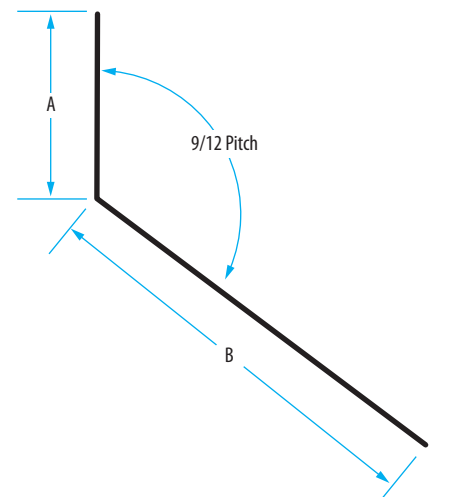

**30 Gauge Painted Roof to Wall** 10 ft. lengths · Pack Quantity: 20

Size: A x B	Black	Dark Brown	Gray	White
1 in. x 3 in.	516655	516847	517947	516947
6 in. x 6 in.	-	-	-	516683

**28 Gauge Painted Roof to Wall** 10 ft. lengths · Pack Quantity: 20

Size: A x B	Black	Dark Brown	White
3 in. x 5 in.	RW35BL	RW35BRW	516956
4 in. x 4 in.	516610	516810	516910
4 in. x 6 in.	-	516511	-
6 in. x 6 in.	-	516812	-

**26 Gauge Painted Roof to Wall** 10 ft. lengths · Pack Quantity: 20

Size: A x B	Black	Brown	Dark Brown	Gray	White
1 in. x 3 in.	516215	-	516213	516216	516214
2 in. x 3 in.	516219	-	516217	-	-
3 in. x 5 in.	516223	-	516221	517956	-
4 in. x 4 in.	RW44BL	-	RW44BRW	-	-
4 in. x 6 in.	-	RW46BRIN-26	-	-	-

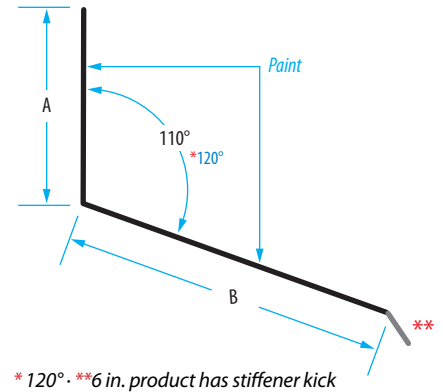

\* 120°. \*\*6 in. product has stiffener kick

**28 Gauge W-Valley** 10 ft. lengths · Pack Quantity: 10

Description	Galv.	Zinc	Black	Brown	Charcoal	D. Brown	White
18 in. - Hemmed	V18G	-	-	V18BR	V18CH	V18BRW	V18WH
24 in. - Hemmed	V24G	V24Z	V24BL	V24BR	-	V24BRW	-

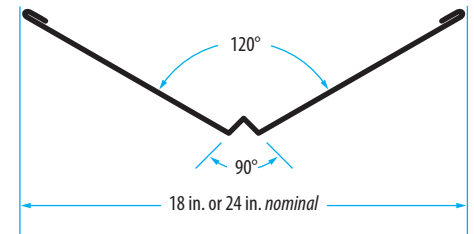

**26 Gauge W-Valley** 10 ft. lengths · Pack Quantity: 10

Description	Galv.	Black	Brown	D. Brown	Gray	W. Wood
18 in. - No Hem	-	516239	-	516237	-	-
20 in. - No Hem	-	-	V20NR-26-NH	-	-	V20WGR-26
24 in. - Hemmed	V24G-26	516247	V24BL	516253	516257	V24WGR-26

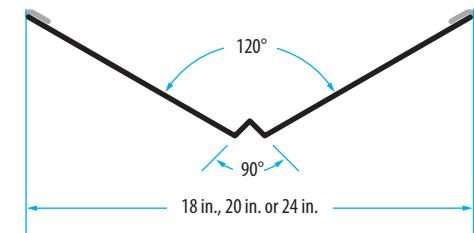

**Zinc W-Valley** 26 Gauge · 10 ft. lengths · Pack Quantity: 10

Description	Part #
18 in. Hemmed	V18Z-26
18 in. No Hem	V18ZNH-26
24 in. Open Hem	V24GOH-26
24 in. 3 Rib, Hemmed	V24Z3R-26
24 in. 5 Rib, Open Hem	V24Z5ROH-26
24 in. Hemmed	V24Z-26

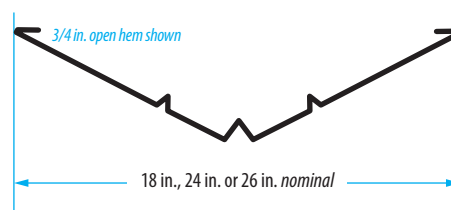

**Tile Valley**

28 Gauge · 10 ft. lengths · Pack Quantity: 10

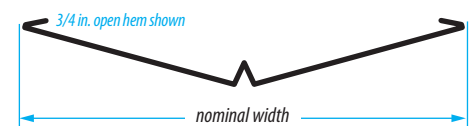

Description	Part #
24 in. - Dark Brown	518751

**30 Gauge Z-Flashing** 10 ft. lengths · 30 Gauge Galvanized Steel · Pack Quantity: 20

Size: A x B x C	Galvanized	Bonderized	Dark Brown	White
1/4 in. x 1-1/4 in. x 1 in.	516766	-	516866	516966
1/4 in. x 1-1/2 in. x 1 in.	516786	-	516886	516986
1/4 in. x 1-5/8 in. x 1 in.	-	-	516896	-
3/8 in. x 1/2 in. x 2 1/8 in.	-	517757	-	-
3/8 in. x 5/8 in. x 2 in.	-	517921	-	-
3/8 in. x 1 in. x 3/4 in.	870125	-	820290	516927
3/8 in. x 1-1/8 in. x 3/4 in.	820067	-	820294	516915
3/8 in. x 2 in. x 3/4 in.	-	-	516836	-

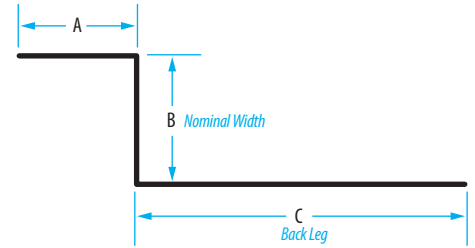

**28 Gauge Z-Flashing** 10 ft. lengths · 28 Gauge Galvanized Steel · Pack Quantity: 20

Size: A x B x C	Galvanized	Bonderized	Brown	Dark Brown	White
1/4 in. x 1-1/4 in. x 2 in.	-	-	-	-	517198*
3/8 in. x 5/16 in. x 2-1/4 in.	516724	-	-	-	-
3/8 in. x 3/8 in. x 2 in.	SZB38G	-	SZB38BR	516821	SZB38WH
3/8 in. x 7/16 in. x 2-1/4 in.	SZB716G	SZB716B	-	-	-
3/8 in. x 1/2 in. x 2-1/8 in.	SZB12G	-	-	SZB12BRW	516958
3/8 in. x 5/8 in. x 2 in.	SZB58G	SZB58B	SZB58BR	SZB58BRW	SZB58WH
3/8 in. x 3/4 in. x 1-7/8 in. - 8 ft.	SZB34GAL-8	-	-	-	-
3/8 in. x 3/4 in. x 1-7/8 in.	SZB34G	SZB34B	-	516859	516959
3/8 in. x 3/4 in. x 2 in.	-	-	-	-	517734*
3/8 in. x 1 in. x 1-5/8 in.	SZB38G-1158	-	-	-	517267
3/8 in. x 1 in. x 2 in.	SZB1G-2	-	-	516623*	517737*
3/8 in. x 1-1/2 in. x 6 in.	-	-	-	517314	-
3/8 in. x 2 in. x 3/4 in.	820099	-	-	-	-
3/8 in. x 2-1/2 in. x 1-1/2 in.	-	516592	-	-	-
2 in. x 1 in. x 2 in.	ZB5G	-	-	-	-
2 in. x 1 in. x 3 in.	ZB6G	ZB6B	-	-	-

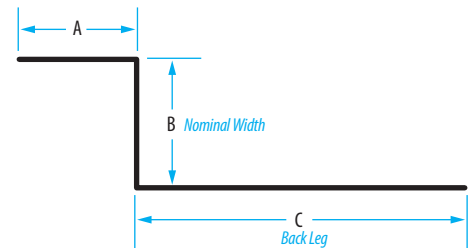

All bends 90° except those marked with \* 100° B leg

**26 Gauge Z-Flashing** 10 ft. lengths · 26 Gauge Galvanized Steel · Pack Quantity: 20

Size: A x B x C	Galvanized	Brown	Charcoal
2 in. x 1 in. x 2 in.	ZB5G-26	-	-
2 in. x 1 in. x 3 in.	ZB6G-26	-	-
2 in. x 1-1/2 in. x 2 in.	ZB55G-26	-	-
3 in. x 1 in. x 3 in.	-	SZB313BR-26	SZB313CH-26

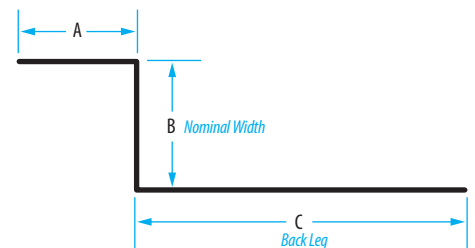

**Millwork Z-Flashing** 10 ft. lengths · 28 Gauge Galvanized Steel · Pack Quantity: 20

Size: A x B x C	Galvanized	Bonderized	White
3/8 in. x 1-1/8 in. x 2 in.	SZB118G-2	-	SZB118WH-2
3/8 in. x 1-1/4 in. x 2 in.	SZB125G-2	-	-
3/8 in. x 1-1/2 in. x 2 in.	SZB115G-2	-	-
1/4 in. x 1-1/4 in. x 1-3/8 in.*	FLGAWF	-	-
1/2 in. x 1-1/2 in. x 2 in.	WT22G	WT22B	-

\*8 ft. lengths

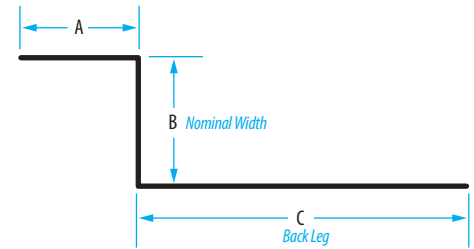

**Stainless Steel Z-Flashing** 10 ft. lengths · 28 Gauge Galvanized Steel · Pack Quantity: 20

Size: A x B x C	Stainless Steel
3/8 in. x 1 1/2 in. x 2-1/8 in.	SZB12SS
3/8 in. x 5/8 in. x 2 in.	SZB58SS
3/8 in. x 3/4 in. x 1-7/8 in.	SZB34SS
3/8 in. x 1 in. x 2 in.	SZB15S-2
3/8 in. x 1-1/2 in. x 2 in.	SZB115SS-2

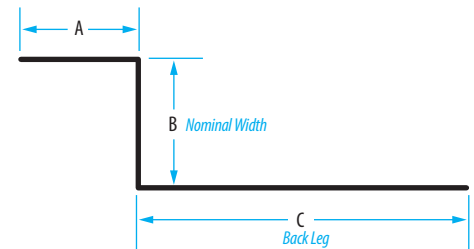

**Siding Corners** Pack Quantity: 200

Size	Part #
1/2 in. x 6 in. - 26 Ga. Bonderized Steel	513002
1/2 in. x 8 in. - 26 Ga. Bonderized Steel	SC128
3/4 in. x 8 in. - 26 Ga. Bonderized Steel	513010
3/4 in. x 12 in. - 26 Ga. Bonderized Steel	SC3412



## Galvanized Steel Roll Flashing

Size	30 Gauge			28 Gauge		26 Gauge
	10 ft.	25 ft.	50 ft.	25 ft.	50 ft.	50 ft.
7 in.	518940	518945	518906	RV725G	-	-
8 in.	-	-	518907	-	-	RV850G-26
10 in.	518941	518946	ERV1050G	RV1025G	-	-
12 in.	-	-	-	RV1225G	-	-
14 in.	518942	518947	518902	RV1425G	RV1450G	RV1450G-26
16 in.	-	-	518917	-	-	-
20 in.	518943	518948	518904	RV2025G	-	RV2050G-26
24 in.	-	-	518919	-	RV2450G	



## Painted Steel Roll Flashing Pack Quantity: 1

Size	Dark Brown 30 Gauge			Black/Gray 30 Ga.	Black/D. Brown 26 Ga.
	10 ft.	25 ft.	50 ft.	50 ft.	50 ft.
7 in.	518980	518985	518932	-	-
8 in.	-	-	-	-	-
10 in.	518981	518986	518933	-	-
14 in.	518982	518987	518930	518991	519027
16 in.	-	-	518929	-	-
20 in.	518983	518988	518931	518992	519028
24 in.	-	-	518960	-	-



## Aluminum Roll Flashing

Size	10 ft.	25 ft.	50 ft.
6 in.	-	RV625A*	-
7 in.	RV710A	518955	RV750A
8 in.	-	RV825A	-
10 in.	RV1010A	RV1025A	RV1050A
14 in.	RV1410A	RV1425A	RV1450A
20 in.	RV2010A	RV2025A	RV2050A
28 in.	-	-	511942



## 7" Spool Painted Steel Roll Flashing

7 inch diameter spool • 28 Gauge • Pack Quantity:1

Size	Part #
20 in. x 50 ft. - Black/Gray	RV2050BLGR
20 in. x 50 ft. - Dark Brown	RV2050BRW-7
20 in. x 50 ft. - White	RV2050WH-7

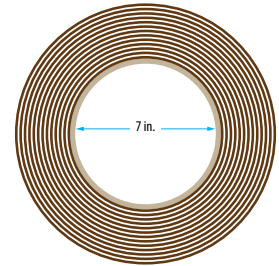

## Flat Stock & Step Flashing

### Flat Stock

Size	Part #	QTY
3 ft. x 4 ft. 28 Gauge Galvanized Steel	FS34G	25
3 ft. x 4 ft. 28 Gauge Bonderized Steel	FS34B	25



### Galvanized Flat Shingles

Size	Part #	QTY
5 in. x 7 in. 30 Ga. Galvanized Steel	511001	100
5 in. x 8 in. 30 Ga. Galvanized Steel	511002	100
8 in. x 12 in. 30 Ga. Galvanized Steel	511011	50
5 in. x 7 in. 28 Ga. Galvanized Steel - 25 pack	S57G-25	10
5 in. x 7 in. 28 Ga. Galvanized Steel - each	S57EA-200	200
5 in. x 8 in. 28 Ga. Galvanized Steel - each	S58EA-200	200
6 in. x 8 in. 28 Ga. Galvanized Steel	S68G-100	100
8 in. x 8 in. 28 Ga. Galvanized Steel - 25 pack	S88G-25	10
8 in. x 12 in. 28 Ga. Galvanized Steel	S812G-50	50
8 in. x 12 in. 28 Ga. Galvanized Steel - each	S812EA-100	100

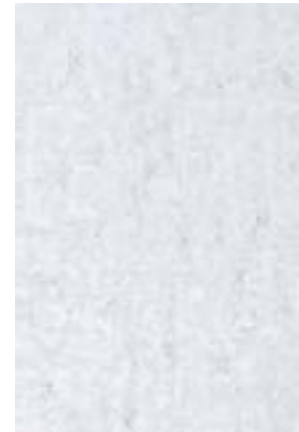

### Painted Flat Shingles

#### Black/Dark Brown • 26 Ga.



26	Part #	Q
5 x 8	511127	100
8 x 8	511129	50
8 x 10	511134	50
8 x 12	511136	50

#### Black/Gray • 28 & 30 Gauge



30	Part #	Q
5 x 8	511024	100
8 x 8	511069	50
8 x 12	511018	50
8 x 14	511045	50

28	Part #	Q
5 x 8	S58BLGREA-200	200
8 x 12	S812BLGREA-100	100

#### Dark Brown • 28 & 30 Gauge

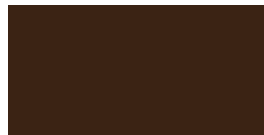

30	Part #	Q
5 x 7	511006	100
5 x 8	511003	100
8 x 8	511019	50
8 x 12	511004	50
8 x 14	511005	50

28	Part #	Q
5 x 8	S58BRWEA-200	200
8 x 12	S812BRWEA-100	100

#### Brown • 28 Gauge



28	Part #	Q
6 x 8	S68BR-100	100
8 x 12	S812BR-50	50

#### White • 30 Gauge

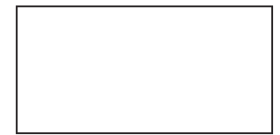

30	Part #	Q
6 x 8	511034	100

#### Gray • 30 Gauge



30	Part #	Q
8 x 8	511093	100



## 30 Gauge Galvanized Step Flashing

Description	Part #	QTY
4 in. x 4 in. x 8 in. - 30 Gauge	511015	50
4 in. x 4 in. x 12 in. - 30 Gauge	511013	50
4 in. x 4 in. x 14 in. - 30 Gauge	518004	50

## 28 Gauge Galvanized Step Flashing

Description	Part #	QTY
3 in. x 3 in. x 7 in. - 28 Gauge - 25 pack	SF337G-25	10
3 in. x 4 in. x 7 in. - 28 Gauge - 50 pack	SF347G-50	50
3 in. x 4 in. x 7 in. - 28 Gauge - each	SF347EA-200	200
3 in. x 5 in. x 7 in. - 26 Gauge	SF357G-26-100	100
3 in. x 5 in. x 8 in. - 28 Gauge. - 25 pack	SF358G-25	10
3 in. x 5 in. x 8 in. - 28 Gauge	SF358G-50	50
4 in. x 4 in. x 8 in. - 28 Gauge - each	SF448EA-50	50
4 in. x 4 in. x 12 in. - 28 Gauge - each	SF4412EA-100	100
4 in. x 6 in. x 14 in. - 28 Gauge - 25 pack	SF4614G-25	25
4 in. x 6 in. x 14 in. - 28 Gauge - each	SF4614EA-50	50



Step Flashing with the word "each" in the description are individually bar coded.

## Painted Step Flashing

### Black - 26, 28 & 30 Gauge

30 Gauge	Part #	QTY
4 x 4 x 8 in.	SF448BLEA30-50	50
4 x 4 x 12 in.	511037	50
4 x 4 x 14 in.	518044	50

28 Gauge	Part #	QTY
4 x 4 x 8 in.	511040	50
4 x 4 x 12 in. - each	SF4412BLEA-100	100

26 Gauge	Part #	QTY
4 x 4 x 8 in.	511062	50

### Dark Brown - 26, 28 & 30 Gauge

28 Gauge	Part #	QTY
4 x 4 x 8 in.	511020	50
4 x 4 x 12 in. - each	SF4412BRWEA-100	100
4 x 6 x 14 in. - 25 pk	SF4614BRW-25	10

30 Gauge	Part #	QTY
4 x 4 x 8 in.	SF448BRWEA30-50	50
4 x 4 x 12 in.	511008	50
4 x 4 x 14 in.	518014	50

26 Gauge	Part #	QTY
4 x 4 x 8 in.	511061	50

### Gray - 30 Gauge

30 Gauge	Part #	QTY
4 x 4 x 8 in.	511050	50
4. x 4 x 12 in.	511038	25
4 x 4 x 14 in.	518054	50

### Brown - 28 Gauge

30 Gauge	Part #	QTY
3 x 5 x 8 in.	SF358BR-50	50

### White - 30 Gauge

30 Gauge	Part #	QTY
4 x 4 x 8 in.	511060	50
4. x 4 x 12 in.	511036	50
4 x 4 x 14 in.	518034	50

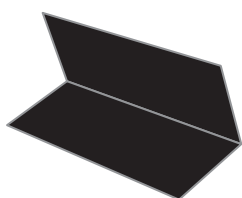

Black

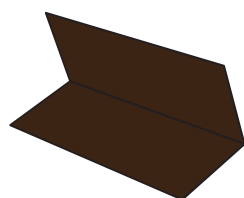

Dark Brown

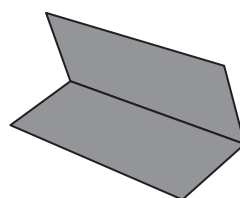

Gray

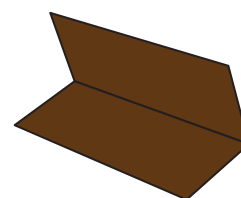

Brown

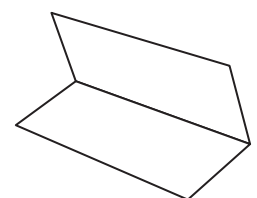

White

## Rubber Sleeve

Adjustable Pipe Flashing - QTY: 20

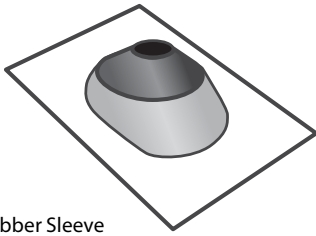

Rubber Sleeve

Size	Part #
Combo Flashing - 1-1/4 - 1-1/2 in.	CMIGB1
Combo Flashing - 2 in.	CMIGB2
Combo Flashing - 3 in.	CMIGB3
Combo Flashing - 4 in.	CMIGB4

## Hard Plastic Base

Adjustable Pipe Flashing - QTY: 20

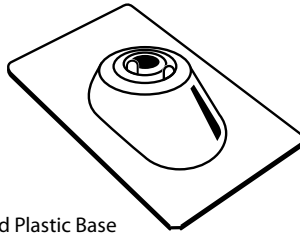

Hard Plastic Base

Size	Part #
Hard Plastic Base - 1 - 3 in.	CMIHB31
Hard Plastic Base - 3 - 4 in.	CMIHB34

## Galvanized Base

Adjustable Pipe Flashing - QTY: 20

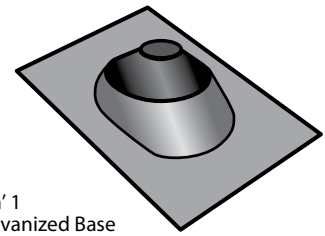

3' n' 1  
Galvanized Base

Size	Galv.	Black	Brown	Gray
1-1/4-3 in.	3-1RJ	559159	559158	559161
3-4 in.	3-4RJ	559166	559165	559167

## Aluminum FHA Pipe Flashing



Size	Part #	QTY
3/4 in.	3FL.75A	25
1 in.	3FL1A	25
1-1/2 in.	3FL1.5A	25
2 in.	3FL2A	25
3 in.	3FL3A	25
4 in.	3FL4A	25
5 in.	3FL5A	25
6 in.	3FL6A	10
7 in.	3FL7A	10
8 in.	3FL8A	10

## Galvanized FHA Pipe Flashing

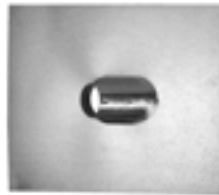

Size	Oval	QTY
1-1/2 in.	RJ15FHA-SP	25
2 in.	RJ2FHA-SP	25
3 in. Soil	RJ3FHA-SL	10
4 in.	RJ4FHA-SL	10

Size	Round	QTY
1-1/2 in.	RJ15FHA-SP-NL	10
2 in.	RJ2FHA-SP-NL	10
3 in. Soil	RJ3FHA-SL-NL	10
4 in.	RJ4FHA-SL-NL	10

Size	Regular Base	QTY
3 - 4 in.	RJ34STD	25
5 - 6 in.	RJ56STD	25
7 - 8 in.	RJ78STD	25

Size	Shake Base	QTY
3 - 4 in.	RJ34SH	25
5 - 6 in.	RJ56SH	25
7 - 8 in.	RJ78SH	25
10 in.	RJ10SH	10
12 in.	RJ12SH	10

## Zinc Pipe Flashing - 26 Gauge



Size	Standard Base	QTY
1/2 in.	3STF.5Z26	25
3/4 in.	3STF.75Z26	25
1 in.	3STF1Z26	25
1 1/2 in.	3STF1.5Z26	25
2 in.	3STF2Z26	25
3 in.	3STF3Z26	25
3 in. Soil	3STF3Z26S	25
4 in.	3STF4Z26S	25
5 in.	3STF5Z26	10
6 in.	3STF6Z26	10

Size	FHA Base	QTY
1/2 in.	3FF.5Z26	25
3/4 in.	3FF.75Z26	25
1-1/2 in.	3FF1.5Z26	25
2 in.	3FF2Z26	25
3 in. Soil	3FF3Z26S	25
4 in.	3FF4Z26	25
4 in. Oval	3FF4Z26O	25
5 in.	3FF5Z26	10
6 in.	3FF6Z26	10
7 in.	3FF7Z26	10
8 in.	3FF8Z26	10
10 in.	3FF10Z26	10

## Plumber's Flashing - Round Cone

Size	26 Gauge Galvanized		26 Gauge Zinc		QTY
	Regular Base	Shake Base	Regular Base	RDS	
1/2 in.	3PF.5G26R	-	3PF.5Z26R	-	25
3/4 in.	3PF.75G26R	-	-	-	25
1 in.	3PF1G26R	-	-	-	25
1-1/2 in.	3PF1.5G26R	3PF1.5G26S	3PF1.5Z26R	3PF1.5Z26RDS	25
2 in.	3PF2G26R	3PF2G26S	-	3PF2Z26RDS	25
3 in.	3PF3G26R	3PF3G26S	-	-	25
4 in.	3PF4G26R	3PF4G26S	-	3PF4Z26RDS	25
8 in.	3PF8G26	-	-	-	10



## Scupper - Left

26 Gauge Galvanized · Pack Quantity: 5 pcs

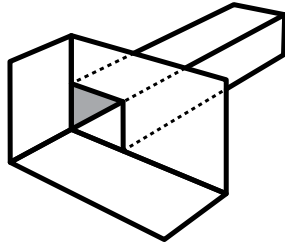

Size: A x B	Part #
2 in. x 3 in. + 10 in. tube	3SPL23G26
3 in. x 4 in. + 10 in. tube	3SPL34G26
4 in. x 6 in. + 10 in. tube	3SPL46G26

## Scupper - Center

26 Gauge Galvanized · Pack Quantity: 10 pcs

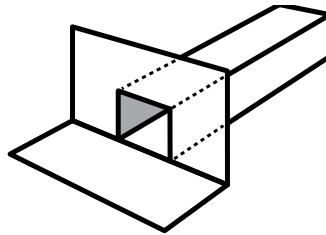

Size: A x B	Part #
2 in. x 3 in. + 10 in. tube	3SPC23G26
3 in. x 4 in. + 10 in. tube	3SPC34G26
4 in. x 4 in. + 10 in. tube	3SPC4G26
4 in. x 6 in. + 10 in. tube	3SPC46G26

## Scupper - Right

26 Gauge Galvanized · Pack Quantity: 5 pcs

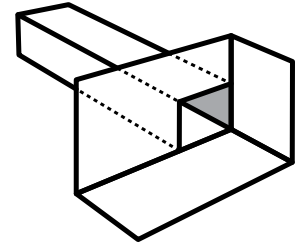

Size: A x B	Part #
2 in. x 3 in. + 10 in. tube	3SPR23G26
3 in. x 4 in. + 10 in. tube	3SPR34G26
4 in. x 6 in. + 10 in. tube	3SPR46G26

## Roof Outlet

28 Ga. Galvanized Steel

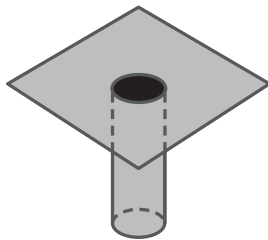

Description	Part #	QTY
2 in. Diameter x 5 in.	2RO25G	25
2 in. Diameter x 10 in.	3RO210G	25
3 in. Diameter x 10 in.	243018	12

## Flue Guard™ Spark Arrestor Chimney Cap

- Sloped lid • 20 gauge powder coated steel
- No tools required • 5/8 in. mesh
- Universal fit: 6 in. x 9 in. up to 14 in. X 22 in.



Description	Part #	QTY
Flue Guard™ Chimney Cap	CG3BLK	4



Genuine 5/8" mesh meets the strict California Fire Code!



**Rectangular Gable Louver: Flange Center** 1/8 inch galvanized insect screen · Pack Quantity: 10

Size: A x B	N.F.V.	Galvanized	Brown	White
12 in. x 12 in.	50.5 sq. in.	GLFC1212G	GLFC1212BR	GLFC1212WH
12 in. x 18 in.	79.0 sq. in.	GLFC1218G	GLFC1218BR	GLFC1218WH
14 in. x 12 in.	56.2 sq. in.	-	-	GLFC1412WH
14 in. x 18 in.	93.4 sq. in.	-	GLFC1418BR	GLFC1418WH
14 in. x 24 in.	131.6 sq. in.	GLFC1424G	GLFC1424BR	GLFC1424WH

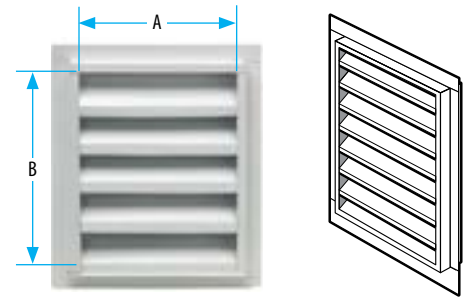

**Rectangular Gable Louver: Flange Front** 1/8 inch galvanized insect screen

Size: A x B	N.F.V.	Galvanized	White	QTY
12 in. x 12 in.	50.5 sq. in.	GLFF1212G-1/8	GLFF1212WH-1/8	10
12 in. x 18 in.	79.0 sq. in.	GLFF1218G-1/8	GLFF1218WH-1/8	10
14 in. x 12 in.	56.2 sq. in.	-	GLFF1412WH-1/8	10
14 in. x 18 in.	93.4 sq. in.	GLFF1418G-1/8	GLFF1418WH-1/8	10
14 in. x 24 in.	131.6 sq. in.	GLFF1424G-1/8	GLFF1424WH-1/8	10
18 in. x 24 in.	165.7 sq. in.	GLFF1824G-1/8	-	5
24 in. x 24 in.	221.5 sq. in.	GLFF2424G-1/8	-	5

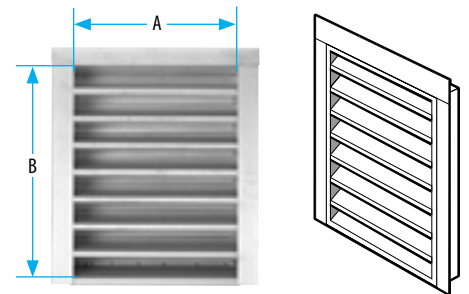

**Rectangular Gable Louver: Plaster Ground** 1/8 inch galvanized insect screen

Size: A x B	N.F.V.	Galvanized	QTY
12 in. x 12 in.	50.5 sq. in.	GLPG1212G-1/8	10
12 in. x 18 in.	79.0 sq. in.	GLPG1218G-1/8	10
14 in. x 12 in.	56.2 sq. in.	GLPG1412G-1/8	10
14 in. x 18 in.	93.4 sq. in.	GLPG1418G-1/8	10
14 in. x 24 in.	131.6 sq. in.	GLPG1424G-1/8	10
18 in. x 24 in.	170.8 sq. in.	GLPG1824G-1/8	5
24 in. x 24 in.	221.5 sq. in.	GLPG2424G-1/8	5

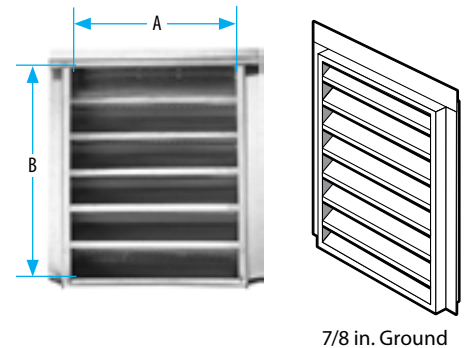

**Bonderized Gable Louver** 1/8 inch galvanized insect screen

Size: A x B	N.F.V.	Part #	QTY
14 in. x 18 in. Flange Front	93.4 sq. in.	GLFF1418B-1/8	10
14 in. x 18 in. Plaster Ground	93.4 sq. in.	GLPG1418B-1/8	10
14 in. x 24 in. Plaster Ground	131.6 sq. in.	GLPG1424B-1/8	10

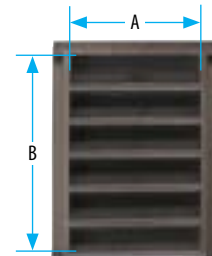

**Norwesco® Reversible Vent** 30 Ga. Galvanized Steel · Louvered Screen · Reversible design for more flexible installation.

Size: A x B	N.F.V.	Galv.	Dk. Brown	White	QTY
8 in. x 12 in.	24 sq. in.	553200	-	-	6
12 in. x 12 in.	62 sq. in.	553220	553520	-	6
12 in. x 18 in.	100 sq. in.	553230	553530	553830	6
14 in. x 24 in.	162 sq. in.	553250	553550	553850	6
24 in. x 30 in.	358 sq. in.	553270	-	-	2

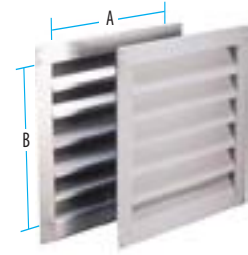

**Econo Vent** 26 Gauge Galvanized Steel · Flat roof.

Size	N.F.V.	Part#	QTY
12 x 12 in.	160 sq. in.	1212EV	2
18 x 18 in.	240 sq. in.	1818EV	2



**J-Vent** 26 Gauge Galvanized Steel · Pack Quantity: 6

Size	N.F.V.	Part #	Flange
3 inch	7 sq. in.	JV328	3 in. x 8 in.
4 inch	12 sq. in.	JV428	4 in. x 9 in.
8 inch	50 sq. in.	JV826	8 in. x 15 in.

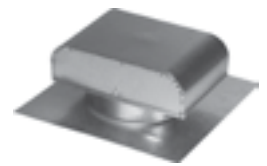

**T-Top** 26 Gauge

Description	Aluminum	Galvanized	Bonderized	Zinc	QTY
4 in. Standard Base	-	RJ4G	RJ4B	-	12
4 in. FHA Base - Hemmed	3TT4A	-	-	-	105
4 in. FHA Base - Unhemmed	-	3TT4G26	-	3TT4Z26	105
7 in. Standard Base	-	RJ7G	RJ7B	-	8
7 in. FHA Base - Unhemmed	3TT7A	-	-	3TT7Z26	50
7 in. Shake Base - Unhemmed	-	3TT7G26-HEM	-	3TT7Z26SEC	50

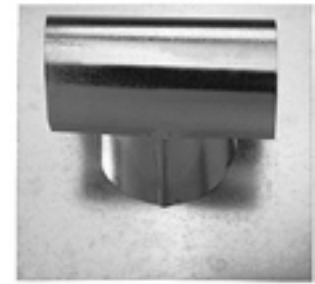

**Total JACK™** The only roof jack with an adjustable stack and base. Adjusts to fit most roof pitches.

Size	Mill	Black	Brown	Weathered Wood	QTY
6 in.	JACK6GZ	JACK6BLK	JACK6BRN	JACK6WWD	7
8 in.	JACK8GZ	JACK8BLK	JACK8BRN	JACK8WWD	6

Galvanized steel in accordance to ASTM A924/A653  
**Base Material:** Galvanized 0.016 in. / Painted 0.019 in.  
**Stack Material:** Galvanized 0.012 in. / Painted .013 in.  
**Cap Material:** Galvanized 0.012 in. / Painted 0.013 in.



**T-Top Sub-Base**

Size	Part #	QTY
4 in. Sub Base - 28 Ga.	SJ4G	20
5-6 in. Sub Base - 26 Ga.	3SBF56G26	20
7 in. Sub Base - 28 Ga.	SJ7G	20

**Vent Adapter** For 6 in. circular roof vent

4 inch	6 inch	7 inch	QTY
559174	559176	559177	6



## Vent Caps

Size	Round	Oval	QTY
3 inch	RBVC3	-	24
4 inch	RBVC4	OBVC4	24
5 inch	RBVC5	-	12
6 inch	RBVC6	-	6



Oval



Round



## Code Caps & Bases Pack Quantity: 6

Size	Regular Base
3 inch	3CD3BaseR
4 inch	3CD4BaseR
5 inch	3CD5BaseR
6 inch	3CD6BaseR
8 inch	3CD8BaseR

Size	Shake Base
3 inch	3CD3BaseS
4 inch	3CD4BaseS
5 inch	3CD5BaseS
6 inch	3CD6BaseS
8 inch	3CD8BaseS

Size	Top Only
3 inch	3CD3TOP
4 inch	3CD4TOP
4 inch Oval	3CD4TOPO
5 inch	3CD5TOP
6 inch	3CD6TOP
8 inch	3CD8TOP

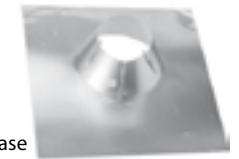

Base

## Half Round Dormer

Federal Spec. QQ-5775A, Type 1, Class 4 ASTM A-527 · Pack Quantity: 6

Size	N.F.V.	Part #
24 in. x 12 in.	100	BH24-1/8

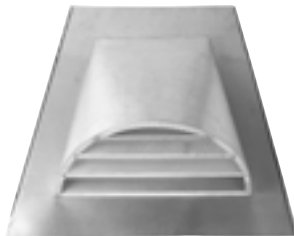

## Low Profile Dormer

Galvanized Steel · Hard Flange · 1/4 in. mesh · Pack Quantity: 10

Size	N.F.V.	Part #
19 in. x 4 in.	43 sq. in.	LPDG19-1/8



## Soft Flange Dormer

1/8 in. galvanized mesh. Pack Quantity: 6  
Galvanized Steel + Soft Aluminum Flange for curved tile roofs

Size	N.F.V.	Part #
24 x 12 - Aluminum 2 sides	91.9 sq. in.	STDS24-2B-1/8
24 x 12 - Aluminum 3 sides	91.9 sq. in.	STDS24-3B-1/8

## Kwik Mesh™

Galvanized - 1/8 in. mesh

Size	Part #	QTY.
4 in. x 25 ft.	KM425	6 rolls
6 in. x 25 ft.	KM625	6 rolls
8 in. x 25 ft.	KM825	3 rolls
12 in. x 20 ft.	KM1220	3 rolls

KM425	34.08 sq. in./ft. N.F.A.
KM625	51.12 sq. in./ft. N.F.A.
KM825	68.16 sq. in./ft. N.F.A.
KM1220	102.24 sq. in./ft. N.F.A.



## Aluminum Mesh

Aluminum - 1/8 in. mesh

Size	Part #	QTY.
4 in. x 100 ft.	969181	6 rolls
6 in. x 100 ft.	969182	4 rolls
8 in. x 100 ft.	969183	3 rolls
12 in. x 100 ft.	969186	2 rolls

**Metal Stem Vent** Pack Quantity: 2

Size	Galv. - Stem Only	Black	Dark Brown	Gray
4 inch	556071	556060	556061	556074
6 inch	556072	556064	556065	-
8 inch	-	556070	556069	-



**Plastic Stem Vent** Pack Quantity: 4

Size	Black	Dark Brown	Gray	White
4 inch	559427	559428	559425	559429
5 inch	559433	559434	-	-
6 inch	559439	559440	559437	-

4 inch Plastic Roof Cap - No Stem - Black	559415	6
4 inch Plastic Roof Cap - No Stem - Dark Brown	559416	6



**24 in. Stealth Vent** 72 sq. in. N.F.V. · 26 Gauge Galvanized Steel · ICC ER-5463 · Dade County 80 mph wind driven rain test

Description	No Hem	Hemmed	QTY
Zinc	3STH24Z26ANH	3STH24Z26A	50
Black	3STH24BL26ANH	3STH24BL26A	50
Brown	3STH24BR26ANH	3STH24BR26A	50
Charcoal	3STH24CH26ANH	3STH24CH26A	50
Sub-Base with Screen	3SBF24Z26STHS	-	10



Roof Deck Opening: 14 in. x 5 in. Hemmed Vent for Tile Roofs; requires Sub-Base.  
Sub Base not required for unhemmed composition shingle application.

Black Mesh, 36, & 48 inch Stealth Vents available upon request, order minimum 100. Contact your Gibraltar Rep for further details.

**50 Square Inch Plastic Vent** Pack Quantity: 12

	Black	Brown	D. Brown	Gray	Translucent	Wth'd Gray	White
PRV-50	559012	559010	559011	559013	-	559015	-
AF-50	559453	559450	559454	559451	559449	559452	559455



PRV-50



AF-50

**92 Square Inch Plastic Vent**



\* Translucent Vent has a Gray Base

Black	Brown	Dk. Brown	Gray	Translucent	Weathered Gray	QTY
559471	559468	559472	559469	559445*	559470	8

**61 Square Inch Plastic Vent**



Color	Part #	QTY
Black	90121	10

**38 Square Inch Steel Vent** Slant Back · Galvanized Steel · 17 in. x 20 in. flange

Galvanized	Black	Dark Brown	Gray	White	QTY
558011	557167	556157	557157	556167	6



**38 Square Inch Steel Vent** Square Top · Galvanized Steel · 17 in. x 17 in. flange

	Galvanized	Black	Dark Brown	Gray	White	QTY
Standard	556042	557059	556159	557159	556150	6
Torch Down	-	557168	556186	557171	557164	4



**40 Square Inch Steel Vent** Slant Back · Galvanized Steel

Black	Brown	QTY
RVG40010	RVG40080	9



**49 Square Inch Steel Vent** Slant Back · 18 in. x 22 in. flange

Galvanized	Black	Dk. Brown	Gray	White	QTY
558012	557153	556154	557154	557145	6



**49 Square Inch Steel Vent** Square Top · 18 in. x 18 in. flange

Black	Dark Brown	Gray	QTY
557160	556158	557158	6



**50 Square Inch Steel Vent**

Description	Galvanized	Black	Brown	QTY
Square Top	RVG51000	RVG51010	RVG51080	9
Slant Back	-	RVG55016	RVG55086	6
50 Square Inch Aluminum Vent - Mill Finish			RVA510000	12





### Ventilating Access Door

1/8 inch mesh · For crawl space access



18 in. x 24 in. | R.O.: 18.25 in. x 25 in.

Description	Part #	QTY
Ventilating Access Door	CHADS-1/8	10

### Tub Access Door

Pressure fit door · Drywall Frame



14 in. x 14 in.

Description	Part #	QTY
Tub Access Door	TA14DW	10

### 4 Inch Dryer Cap



Description	Part #	QTY
Galvanized Steel	DV4	14

### Aluminum Louvered Vents

For soffit and eave venting

Size: A x B	N.F.V.	R. Opening	Mill	Brown	White	QTY.
16 in. x 4 in.	28 sq. in.	15 in. x 3 in.	84126	84228	84226	24
16 in. x 6 in.	42 sq. in.	15 in. x 5 in.	84115	84217	84215	24
16 in. x 8 in.	56 sq. in.	15 in. x 7 in.	84210	84212	84211	24



### Flat Screen Vent

Galvanized Steel · 1/8 in. mesh

Size: A x B	N.F.V.	Rough Opening	Part #	QTY.
16 in. x 4 in.	23.7 sq. in.	14.5 in. x 2.5 in.	SCV164-1/8	25
16 in. x 6 in.	42.6 sq. in.	14.5 in. x 4.5 in.	SCV166-1/8	25
16 in. x 8 in.	61.5 sq. in.	14.5 in. x 6.5 in.	SCV168-1/8	25



### Two Way Vents

Galvanized steel · 1/8 in. mesh · Reversible flange for plaster or surface mount

Size: A x B	N.F.V.	Rough Opening	Part #	QTY.
14 in. x 4 in.	28.4 sq. in.	13.75 in. x 3.25 in.	TW144-1/8	30
14 in. x 6 in.	44.8 sq. in.	13.75 in. x 5.25 in.	TW146-1/8	24
14 in. x 8 in.	62.2 sq. in.	13.75 in. x 7.25 in.	TW148-1/8	16



### Two Way Vent

With decorative floral plastic insert

Description	Part #	QTY.
14 in. x 6 in. Vent + Insert	TWPIV-1/8	24
Insert only	PIV614	24



### Mini Louver

Aluminum, with Screen

Size	N.F.V.	Part #	QTY.
1-1/2 inch	0.39 sq. in.	ML1.5	12
2 inch	0.45 sq. in.	559111	36
2-1/2 inch	1.2 sq. in.	559112	36
3 inch	1.7 sq. in.	559001	36
4 inch	3.5 sq. in.	559002	36



### Mini Louver

Aluminum, no Screen

Size	N.F.V.	Part #	QTY.
2 inch	0.47 sq. in.	ML2	100
3 inch	1.34 sq. in.	ML3	50
4 inch	2.88 sq. in.	ML4	20

## Continuous Soffit Vent

Description	N.F.V.	Mill	Black	Brown	White	QTY.
Aluminum	9 sq. in./ft.	556004	556014	556018	556019	30
Plastic	8.2 sq. in./ft.	n/a	-	559006	559007	75



## Soffit Vent Stucco Ready · 1/8 inch mesh

Size: A x B	N.F.V.	Rough Opening	Part #	QTY.
14 in. x 5 in.	52.1 sq. in.	14.5 in. x 5.5 in.	SV145-1/8	26
22 in. x 3 in.	51.4 sq. in.	22.5 in. x 3.25 in.	SV223-1/8	9



## Flush Mount Soffit Vent 1/8 inch Mesh · Pack Quantity: 12

Description	N.F.V.	Galvanized	Brown	White	QTY.
16 in. x 4 in.	24 sq. in.	556005	556146	556446	12
16 in. x 6 in.	40 sq. in.	558006	556147	556447	12
16 in. x 8 in.	58 sq. in.	558007	556148	556448	12



## Flush Mount Soffit Vent With Damper · 1/8 inch Mesh · Pack Quantity: 12

Description	N.F.V.	Galvanized	Brown	White	QTY.
16 in. x 4 in.	24 sq. in.	558025	556161	556461	12
16 in. x 6 in.	40 sq. in.	558026	556162	556462	12
16 in. x 8 in.	50 sq. in.	558027	556163	556463	12



with manual damper

## Eave Vent Stucco or Straight Flange · 1/8 inch mesh

Size	N.F.V.	Galvanized	Bonderized	Brown	QTY.
22 in. x 3 in. - 1/8 mesh - STU	34.3 sq. in.	EV223-1/8	-	-	25
22 in. x 3 in. - 1/8 mesh - REG	34.3 sq. in.	-	556017	556015	50
22 in. x 3 in. w/Louvers - REG	34.3 sq. in.	-	556007	-	50
22 in. x 6 in. - 1/8 mesh - REG	61.7 sq. in.	EV622 -1/8	-	-	25
14 in. x 5 in. - 1/8 mesh - STU	38.2 sq. in.	EV145 -1/8	-	-	25
14 in. x 6 in. - 1/8 mesh - REG	38.2 sq. in.	EV614 -1/8	-	-	25



STU = Stucco Flange  
REG = Straight Flange

## Adjustable Foundation Vent

Aluminum, with sliding damper



Description	N.F.V.	Part#	QTY.
16 in. x 8 in.	102 sq. in.	FA109000	12

## Stamped Foundation Vent Stucco Reveal



### Galvanized

Description	N.F.V.	Part #	QTY.
14 x 6 in. - 1/8 mesh	51	FV146G-1/8	25
16 x 8 in. - 1/8 mesh	75	558037	30

### Bonderized

14 x 6 in. - 1/4 mesh	51	FV146B-1/8	25
-----------------------	----	------------	----

## Rim Vent Pack Quantity: 24



Rugged UV resistant plastic

Description	N.F.V.	Part #
16 in. x 8 in. - White	62 sq. in.	559408

## Damper Doors - Foundation Vent Clips

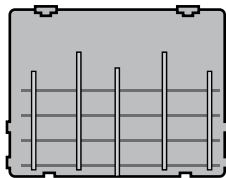

Description	Part#	QTY.
Vent-Aire Door	559217	80
Norwesco - PFV6-8	596140	72

## Foam Plugs Sold in Pairs



DVBPSM-EA

DVBP

DVBPXL

Description	Part#	QTY.
Lawrence - 5.5 in. x 7.5 in.	DVBPSM-EA	45
Vent-Aire - 6.5 in. x 7.75 in.	DVBP	40
Norwesco - 6.5 in. x 8.75 in.	DVBPXL	36

## Pour-In-Place Foundation Vent

Description	N.F.V.	Color	Part#	QTY.
PFV-6-8 Combo	100 sq. in.	Gray	596037	12
PFV-6-8 Combo - with damper door	100 sq. in.	Gray	596137	12
6 in.- with damper door	72.5 sq. in.	Gray	DVB6	20
6 in. - no door	72.5 sq. in.	Gray	559021	20
6 in. - with damper door	72.5 sq. in.	Gray	559023	20
6 in. - no door	72.5 sq. in.	Black	559020	20
6 in. - with damper door	72.5 sq. in.	Black	559022	20
8 in. - no door	72.5 sq. in.	Gray	559027	15
8 in. - with damper door	72.5 sq. in.	Gray	DVB8	15
8 in. - no door	72.5 sq. in.	Black	559026	15
8 in. - with damper door	72.5 sq. in.	Black	559028	15
10 in. - with damper door	72.5 sq. in.	Gray	559035	12



## Galvanized Vent Wells

Description - A x B x C	Part#	QTY.
Rectangular - 20 in. x 4 in. x 12	FVW204-12	10
Rectangular - 20 in. x 4 in. x 12 - 20 Gauge	553031	5
Rectangular - 20 in. x 8 in. x 12 - 20 Gauge	553022	5
Rectangular - 20 in. x 12 in. x 12 - 20 Gauge	553001	6
Arched - 20 in. x 8 in. x 12	FVW208-12	10

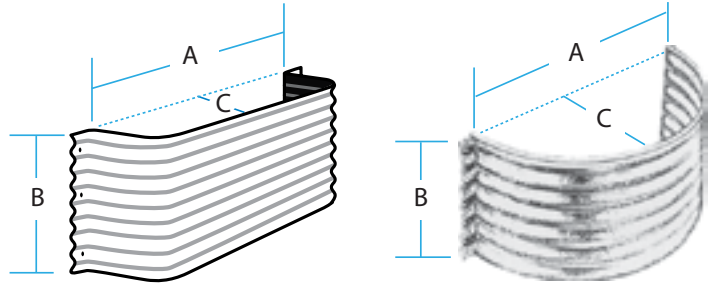

## Plastic Vent Wells

Description - A x B x C	Part#	QTY
Dark Brown - 19 in. x 4 in. x 12	569040	10
Gray - 19 in. x 4 in. x 12	569041	10
Gray - 19 in. x 8 in. x 12	569081	6

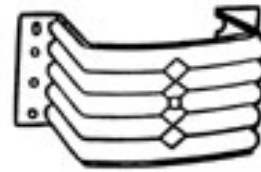

## Rain Diverter

Description	Part #	QTY
28 Ga. Galvanized - 1 1/2 in. x 4 in. x 1/2 in. - 6 ft. Length	RD672G	20
26 Ga. Zinc - 2 in. x 8 1/2 in. x 1/2 in. - 10 ft. Length	RD2855-Z	20

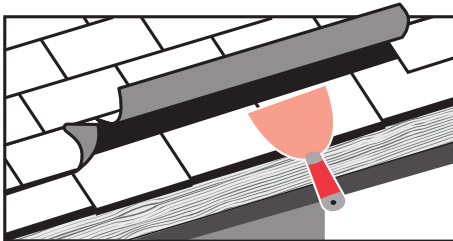
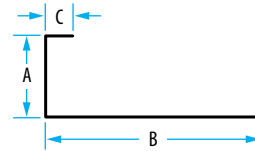

Gently lift 2nd row of shingles, directly above the doorway.

Rain Diverter can also be used to evenly disperse 2nd story downspout runoff to a pitched 1st story roof.

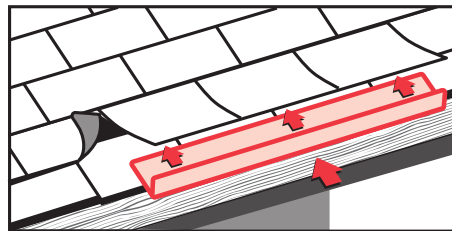

Slide Rain Diverter under shingles as far as it will go, giving it a slight pitch to one side.

Your Rain Diverter should extend at least 1 ft. on either side of the doorway. Cut to desired length with tin snips. For lengths greater than 60 in., overlay 2 or more Rain Diverters.

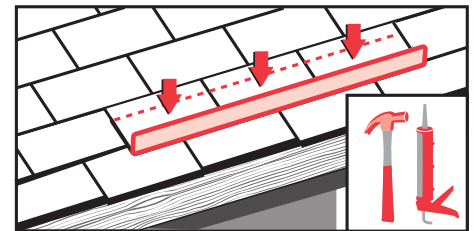

Fasten with 3 hot dipped galvanized roofing nails.

Seal nail heads with roofing cement and press shingles back into place.

## 90° Tape-On Odd Leg Outside Corner

8 ft. Carton	10 ft. Carton	MLF	Pieces/Carton	Cartons/Pallet
A1W-8	A1W-10	83.5 lbs.	50	60

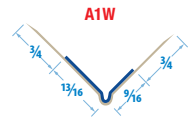

## 90° Tape-On Extra Wide Odd Leg Outside Corner

8 ft.	9 ft.	10 ft.	12 ft.	MLF	Pcs/Ctn	Ctns/Pal
A1XW-8	A1XW-9	A1XW-10	A1XW-12	95 lbs.	50	60

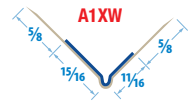

## 90° Tape-On Extra Wide Even Leg Outside Corner

8 ft.	9 ft.	10 ft.	12 ft.	MLF	Pcs/Ctn	Ctns/Pal
A1XWEL-8	A1XWEL-9	A1XWEL-10	A1XWEL-12	95 lbs.	50	60



## 90° Tape-On Extra Wide Even Leg Outside Corner - Sunline™

7 ft.	8 ft.	9 ft.	10 ft.	12 ft.	MLF	Pcs/Ctn	Ctns/Pal
S1XW-7	S1XW-8	S1XW-9	S1XW-10	S1XW-12	103.34 lbs.	50	54

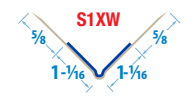

## 90° Tape-On Extra Extra Wide Even Leg Outside Corner - Sunline™

8 ft.	9 ft.	10 ft.	12 ft.	MLF	Pcs/Ctn	Ctns/Pal
S1XXW-8	S1XXW-9	S1XXW-10	S1XXW-12	121.7 lbs.	50	54

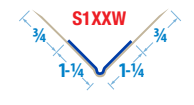

## Taper's Bead™ 90° Tape-On Even Leg Outside Corner

7 ft.	8 ft.	9 ft.	10 ft.	12 ft.	MLF	Pcs/Ctn	Ctns/Pal
T1WEL-7	T1WEL-8	T1WEL-9	T1WEL-10	T1WEL-12	83.5 lbs.	50	60



🍁 Only available in Canada.

## Taper's Bead™ 90° Tape-On Extra Wide Even Leg Outside Corner

7 ft.	8 ft.	9 ft.	10 ft.	12 ft.	MLF	Pcs/Ctn	Ctns/Pal
T1XWEL-7	T1XWEL-8	T1XWEL-9	T1XWEL-10	T1XWEL-12	95.5 lbs.	50	60



🍁 Only available in Canada.

## Taper's Choice™ 90° Tape-On Extra Wide Outside Corner

6 ft.	7 ft.	8 ft.	9 ft.	10 ft.	12 ft.	MLF	Ctn	Pal
TC1XW-6	TC1XW-7	TC1XW-8	TC1XW-9	TC1XW-10	TC1XW-12	103.34 lbs.	50	54



🍁 Only available in Canada.

## Taper's Choice™ 90° Tape-On Extra Extra Wide Outside Corner

7 ft.	8 ft.	9 ft.	10 ft.	12 ft.	MLF	Pcs/Ctn	Ctns/Pal
TC1XXW-7	TC1XXW-8	TC1XXW-9	TC1XXW-10	TC1XXW-12	119.75 lbs.	50	54



🍁 Only available in Canada.

## 135° Tape-On Open Angle Outside Corner

8 ft. Carton	9 ft. Carton	10 ft. Carton	MLF	Pcs/Ctn	Ctns/Pal
A10A-8	A10A-9	A10A-10	73.5 lbs.	50	60

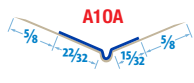

## 90° Tape-On Inside Corner

8 ft.	10 ft.	2.7 Meter	3.0 Meter	MLF	Pcs/Ctn	Ctns/Pal
A2-8	A2-9	A2-2.7	A2-3.0	48.5 lbs.	50	60

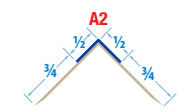

## 135° Tape-On Open Angle Inside Corner

8 ft. Carton	9 ft. Carton	10 ft. Carton	MLF	Pcs/Ctn	Ctns/Pal
A20A-8	A20A-9	A20A-10	73.5 lbs.	50	60

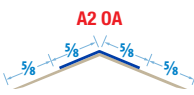

## 90° Tape-On L-Trim Outside Corner



**Tape-On L-Trim** is used as a trim piece for wallboard that abuts to suspended ceilings, plaster beams, masonry and concrete surfaces, as well as untrimmed window and door jambs.

50 Pieces per Carton  
60 Cartons per Pallet

### 1/4 inch

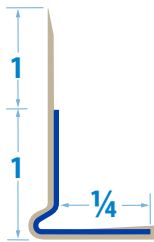

10 ft. Ctn. .... **A4-1/4-10**  
LBS/MLF ..... **73.5**

### 1/2 inch

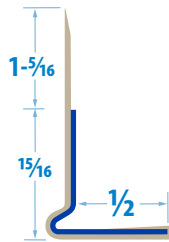

7 ft. Ctn. .... **A4-1/2-7**  
8 ft. Ctn. .... **A4-1/2-8**  
10 ft. Ctn. .... **A4-1/2-10**  
LBS/MLF ..... **83.5**

### 1/2 inch No Bead

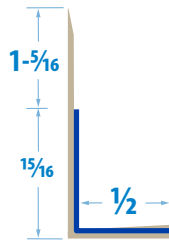

8 ft. Ctn. .... **A4-1/2NB-8**  
10 ft. Ctn. .... **A4-1/2NB-10**  
12 ft. Ctn. .... **A4-1/2NB-12**  
LBS/MLF ..... **83.5**

### 5/8 inch

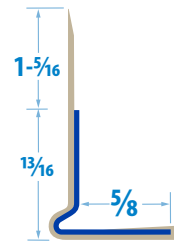

7 ft. Ctn. .... **A4-5/8-7**  
8 ft. Ctn. .... **A4-5/8-8**  
10 ft. Ctn. .... **A4-5/8-10**  
LBS/MLF ..... **83.5**

### 5/8 inch No Bead

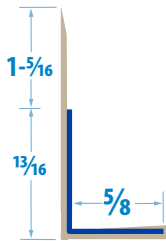

8 ft. Ctn. .... **A4-5/8NB-8**  
10 ft. Ctn. .... **A4-5/8NB-10**  
LBS/MLF ..... **83.5**

### 3/4 inch

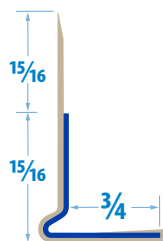

8 ft. Ctn. .... **A4-3/4-8**  
10 ft. Ctn. .... **A4-3/4-10**  
LBS/MLF ..... **95.0**

### 1 inch

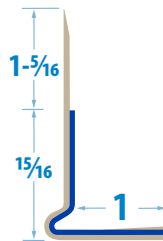

8 ft. Ctn. .... **A4-1-8**  
10 ft. Ctn. .... **A4-1-10**  
LBS/MLF ..... **109.0**

### 1 inch No Bead

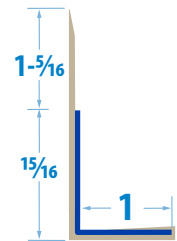

10 ft. Ctn. .... **A4-1NB-10**  
LBS/MLF ..... **109.0**

### 1-1/4 inch

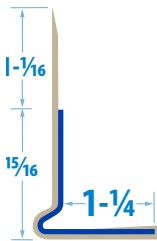

10 ft. Ctn. .... **A4-1-1/4-10**  
LBS/MLF ..... **120.75**

## Tape-On Z Shadow Trim

10 ft. Carton	MLF	Pieces/Carton	Cartons/Pallet
AST-1/2-10	109 lbs	50	60
AST-5/8-10	121 lbs	50	60

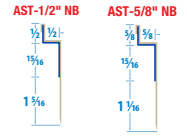

## Tape-On Reveal Trim

10 ft. Carton	MLF	Pieces/Carton	Cartons/Pallet
ART-1/2-10	109 lbs	50	60
ART-5/8-10	121 lbs	50	60

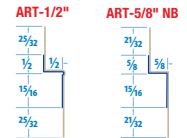

## 1/2 inch Tape-On J-Trim

7 ft. Carton	8 ft. Carton	10 ft. Carton	MLF	Pieces/Carton	Cartons/Pallet
A9-1/2-7	A9-1/2-8	A9-1/2-10	95 lbs	25	54

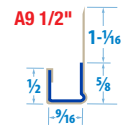

Edge Cap Tape on One Leg

## 5/8 inch Tape-On J-Trim

7 ft. Carton	8 ft. Carton	10 ft. Carton	MLF	Pieces/Carton	Cartons/Pallet
A9-5/8-7	A9-5/8-8	A9-5/8-10	95 lbs	25	54

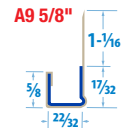

Edge Cap Tape on One Leg

## 1/2 inch Radius Mini Bull™ Tape-On Outside Corner - Sunline™

MLF: 84 lbs. · Pieces per carton: 50 · Cartons per pallet: 54

7 ft.	8 ft.	8 ft. 6 in.	9 ft.	10 ft.	10 ft. 6 in.	12 ft.
SMB-7	SMB-8	SMB-8.6	SMB-9	SMB-10	SMB-10.6	SMB-12

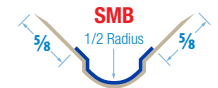

SUN LINE™

## 3/4 inch Radius Bullnose Tape-On Outside Corner - Sunline™

MLF: 84.18 lbs. · Pieces per carton: 50 · Cartons per pallet: 60

7 ft.	8 ft.	8 ft. 6 in.	9 ft.	10 ft.	10 ft. 6 in.	12 ft.
SBN-7	SBN-8	SBN-8.6	SBN-9	SBN-10	SBN-10.6	SBN-12



SUN LINE™

## 3/4 inch Radius Bullnose Tape-On Outside Corner

8 ft. Carton	9 ft. Carton	10 ft. Carton	MLF	Pieces/Carton	Cartons/Pallet
ABN-8	ABN-9	ABN-10	95.5 lbs.	50	60



ABN

## 3/4" Radius Bullnose Tape-On Open Angle 135° Outside Corner

8 ft. Carton	9 ft. Carton	12 ft. Carton	MLF	Pcs/Ctn	Ctn/Pal
ABNOA-8	ABNOA-9	ABNOA-12	159.5 lbs.	50	60



ABN OA

## Extra Large Radius Bullnose Tape-On Outside Corner

MLF: 159.5 lbs

9 ft.	10 ft.	10 ft. 6 in.	12 ft.	Pieces/Carton	Cartons/Pallet
ABNXLR-9	ABNXLR-10	ABNXLR-10.6	ABNXLR-12	25	52



ABN XLR

## Paperfaced Nail-On Corner Bead

### 90° Paperfaced Nail-On Extra Extra Wide Even Leg Outside Corner - Sunline™

8 ft. Carton	9 ft. Carton	10 ft. Carton	12 ft. Carton	MLF	Pcs/Ctn	Ctn/Pal
S1XXWN-8	S1XXWN-9	S1XXWN-10	S1XXWN-12	117 lbs.	50	54

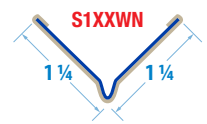

### 1/2 inch Radius Mini Bull™ Paperfaced Nail-On Outside Corner - Sunline™

8 ft. Carton	9 ft. Carton	10 ft. Carton	12 ft. Carton	MLF	Pcs/Ctn	Ctn/Pal
SMBN-8	SMBN-9	SMBN-10	SMBN-12	117 lbs.	50	54

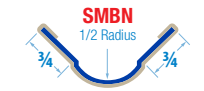

### 1/2 inch Radius Mini Bull™ Kerf Paperfaced Nail-On Outside Corner - Sunline™

10 ft. Carton	MLF	Pieces/Carton	Cartons/Pallet
SMBN-KERF-10	117 lbs.	50	60

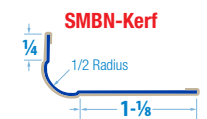

### 3/4 inch Radius Bullnose Paperfaced Nail-On Outside Corner - Sunline™

8 ft. Carton	9 ft. Carton	10 ft. Carton	MLF	Pieces/Carton	Cartons/Pallet
SBNN-8	SBNN-9	SBNN-10	117.34 lbs.	50	60



### 3/4 inch Radius Bullnose Paperfaced Nail-On Extra Wide Outside Corner - Sunline™

7' 6" Carton	8 ft. Carton	9 ft. Carton	10 ft. Carton	MLF	Pcs/Ctn	Ctn/Pal
SBNNXW-7.6	SBNNXW-8	SBNNXW-9	SBNNXW-10	139.03 lbs.	50	54



### 3/4" Radius Bullnose Nail-On Open Angle Outside Corner - Sunline™

9 ft. Carton	10 ft. Carton	MLF	Pieces/Carton	Cartons/Pallet
SBN-NOA-9	SBN-NOA-10	159.5 lbs.	50	60





## Straight Fascia Gutter 26 Gauge Galvanized Steel

Size	Length	With Wing	No Wing	QTY
2 x 4	10 ft.	216724	-	10
2 x 4	20 ft.	216823	216821	6
2 x 4	25 ft.	216913	216911	6
2 x 4	26 ft.	216923	-	4
2 x 4	30 ft.	216943	-	4
2 x 6	20 ft.	216829	216827	4
2 x 6	25 ft.	216919	216917	4
2 x 6	26 ft.	216929	-	4

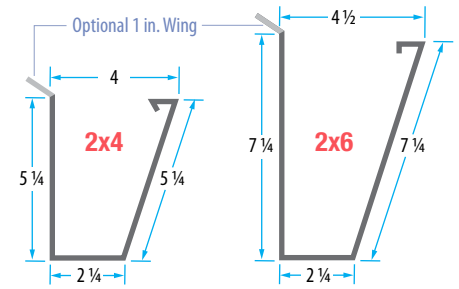

## Straight Fascia Gutter 26 Gauge Bonderized Steel

Size	Length	With Wing	No Wing	QTY
2 x 4	10 ft.	FG2410WWB	FG2410NWB	10
2 x 4	16 ft.	FG2416WWB	FG2416NWB	6
2 x 4	20 ft.	FG2420WWB	216822	6
2 x 4	25 ft.	FG2425WWB	216912	6
2 x 4	26 ft.	216924	-	4
2 x 4	30 ft.	216944	-	4
2 x 6	20 ft.	216830	-	4
2 x 6	25 ft.	216920	-	4
2 x 6	26 ft.	216930	-	4
2 x 6	30 ft.	216950	-	4

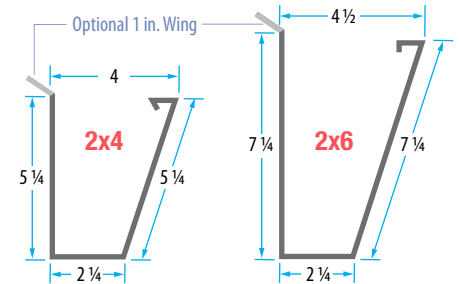

## Curved Fascia Gutter 26 Gauge Steel · With wing

Size	Length	Galvanized	Bonderized	QTY
2 x 4	20 ft.	216833	216834	6
2 x 4	25 ft.	216837	176046	6
2 x 4	30 ft.	-	176048	4
2 x 6	25 ft.	-	217178	6
2 x 6 - Tile	25 ft.	-	216895	6

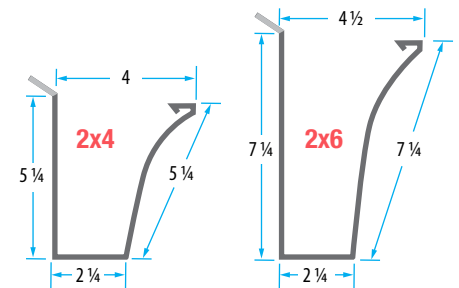

## Deco Fascia Gutter 26 Gauge Steel · With wing

With Wing	Length	Galvanized	Bonderized	QTY
2 x 4 - 5 Rib	20 ft.	-	216524	6
2 x 4 - 5 Rib	25 ft.	-	216614	6
2 x 4 - 5 Rib	26 ft.	216623	216624	4
2 x 4 - 5 Rib	30 ft.	-	216644	4
2 x 6 - 7 Rib	20 ft.	-	217108	6
2 x 6 - 7 Rib	25 ft.	217115	217116	6
2 x 6 - 7 Rib - Tile	25 ft.	-	217139	6
2 x 6 - 7 Rib	26 ft.	-	217120	4
2 x 6 - 7 Rib	30 ft.	-	217128	4

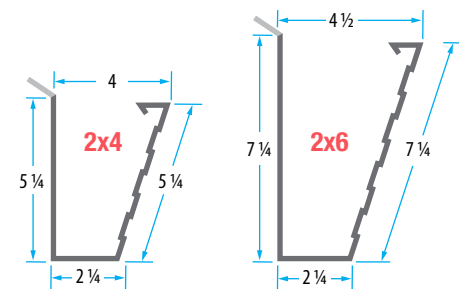

**End Caps** For Straight & Deco Fascia Gutter · Pack Quantity: 50

Galvanized	
2x4 Left	FG24ECLHG
2x4 Right	FG24ECRHG
2x6 Left	FG26ECLHG
2x6 Right	FG26ECRHG

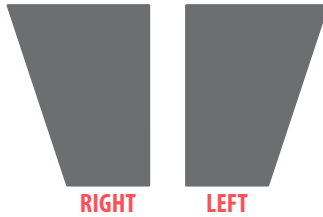

Bonderized	
2x4 Left	FG24ECLHB
2x4 Right	FG24ECRHB
2x6 Left	223035
2x6 Right	223034

**Curved End Caps** Pack Quantity: 50

Galvanized	
2x4 Left	FG23ECLHCG
2x4 Right	FG23ECLHCG
2x6 Left	FG725ECLHCG
2x6 Right	FG725ECRHCG

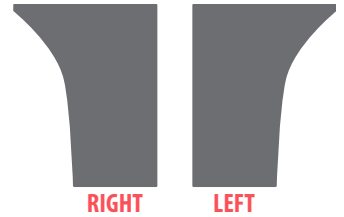

Bonderized	
2x4 Left	FG26ECLHB
2x4 Right	FG26ECRHB
2x6 Left	-
2x6 Right	-

**Slip Connectors** · Pack Quantity: 25

2x4	Part #
Galvanized	FG24SCG
Bonderized	FG24SCB



**End Piece** · Pack Quantity: 12

2x4	Bonderized
2-1/4 in. sq. drop	FG24EP214B
2 in. round drop	FG24EPRD2B



**Outside Mitre** · Pack Quantity: 12

Galvanized	
2x4	FG24OMG
2x6 - RTO	223041



Bonderized	
2x4	FG24OMB
2x6	-

**Inside Mitre** · Pack Quantity: 12

Galvanized	
2x4	FG24IMG
2x6 - RTO	223040



Bonderized	
2x4	FG24IMB
2x6	-

**Elbows** 28 Ga. Bonderized Steel · Pack Quantity: 20

	45°	75°
A - 1 3/4 in. x 2 3/4 in.	CE134234B-A45	CE134234B-A75
B - 1 3/4 in. x 2 3/4 in.	CE134234B-B45	CE134234B-B75
2 in. Round	CERD2B-45	CERD2B-75
3 in. Round - 26 Ga.	CERD3B-45-26	CERD3B-75-26



**Conductor Head** 26 Gauge · Pack Quantity: 10

Galvanized	
1-3/4 x 2-3/4 Sq. Drop	CH134234G
2 x 3 in. Square Drop	CH3423G
3 x 4 in. Square Drop	CH34G
2 in. Round Drop	CHRD2G
3 in. Round Drop	3LH3GR



Bonderized	
1-3/4 x 2-3/4 Sq. Drop	CH134234B
2 in. Round Drop	CHRD2B
3 in. Round Drop	CHRD3B

**Fascia Gutter Hangers** 18 Ga. Galvanized · Pack Quantity: 100



Description	2 x 4	2 x 6
Gutter Hanger (Strap)	GH4G-18	GH725G-18
Hidden Hanger	HH24G-18	HAGAH45
Fascia Gutter Spacers	FGS24G-18	223039
Tile Hanger	-	3HTP

## K-Style Gutter 26 Gauge

Galvanized	With Wing	No Wing	QTY
4 in x 10 ft.	-	216704	10
4 in x 20 ft.	216807	216803	6
4 in x 25 ft.	216848	-	6
4 in x 26 ft.	216841	-	4
4 in x 30 ft.	216843	-	4
5 in x 20 ft.	216819	216815	6
5 in x 25 ft.	216839	-	6

Bonderized	With Wing	No Wing	QTY
4 in x 20 ft.	216808	216804	6
5 in x 20 ft.	216820	216816	6
5 in x 25 ft.	231417	-	6
5 in x 30 ft.	216844	-	4
6 in x 20 ft.	223419	-	6
6 in x 25 ft.	223420	-	6
6 in x 30 ft.	223421	-	4

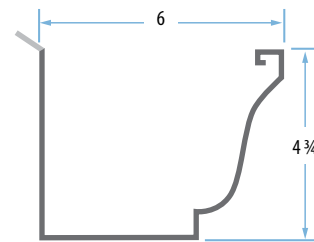
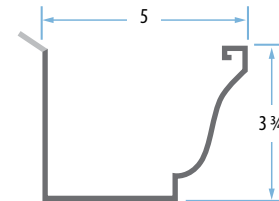
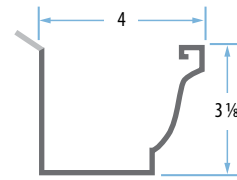

## K-Style Gutter 28 Gauge, No Wing, 10 ft. Lengths · Pack Quantity: 10



	Galvanized	Royal Brown	White	White Alum.
4 in.	OG410G	OG410BR	OG410WH	-
5 in.-	-	OG510BR	OG510WH	OG510WHA

## Slip Connectors 28 Gauge · Pack Quantity: 30



	Galvanized	Royal Brown	White	White Alum.
4 in.	OG4SCG	OG4SCBR	OG4SCWH	-
5 in.-	-	OG5SCBR	OG5SCWH	OG5SCWHA

## Inside Mitre · Pack Quantity: 5



	Galvanized	Royal Brown	White
4 in. Steel	OG4IMG	OG4IMBR	OG4IMWH
5 in Steel	-	OG5IMBR	OG5IMWH
5 in. Aluminum	-	-	OG5IMWHA

## Outside Mitre · Pack Quantity: 5



	Galvanized	Royal Brown	White
4 in. Steel	OG4OMG	OG4OMBR	OG4OMWH
5 in Steel	-	OG5OMBR	OG5OMWH
5 in. Aluminum	-	-	OG5OMWHA

## End Piece

	Galvanized	Royal Brown	White	QTY
4 in. Steel - with 2 in. Round Drop	OGEP42G	-	-	20
4 in. Steel - with 2 in. x 3 in Drop	OG4EP23G	OG4EP23BR	OG4EP23WH	12
5 in. Steel - with 2 in. x 3 in Drop	-	OG5EP23BR	OG5EP23WH	6
5 in. Alum. - with 2 in. x 3 in Drop	-	-	OG5EP23WHA	5



## A-Elbows

	45°	60°	75°	75° Alum.	90°	QTY
1 3/4 in. x 2 3/4 in. - Galvanized	248049	248057	248065	-	248073	20
2 in. x 3 in. - Galv. Corrugated	-	-	CE23G-A75	-	-	15
2 in. x 3 in. - Galvanized	248051	248059	248067	-	248075	20
2 in. x 3 in. - Royal Brown	-	-	CE23BR-A75	-	-	15
2 in. x 3 in. - White - Corrugated	-	-	CE23WH-A75	CE23WHA-A75	-	15



## B-Elbows

	45°	75°	75° Corrugated	75° Aluminum	QTY
1-3/4 in. x 2 3/4 in. - Galvanized	248050	248066		-	20
2 in. x 3 in. - Galvanized	-	248068	CE23G-B75	-	20
2 in. x 3 in. - Royal Brown	-	-	CE23BR-B75	-	15
2 in. x 3 in. - White	-	-	CE23WH-B75	CE23WHA-B75	15



## Round Elbows 26 Gauge. Pack Quantity: 20

	45°	60°	75°	90°	QTY
2 in. - Galvanized	CERD2G-45	-	CERD2G-75	248184	20
3 in. - Galvanized	248185	248186	CERD3G-75	248188	20
4 in. - Galvanized	248189	248190	248191	248192	20



## Drop Outlet 28 Gauge Galvanized Steel

Size	Part#	QTY
1 3/4 in. x 2 3/4 in.	FGDO134234G	25
2 in. x 3 in.	223012	50
3 in. x 4 in.	223013	25
2 in. Round - 26 Gauge	FGDORD2G	25
3 in. Round	FGDORD3G	50
3 in. Round - Half Round Gutter	223079	50
3 in. Oval	3OUT3GKOD	50



## Universal Drop Outlet Plastic



2 in. x 3 in. · OGDO23P · QTY: 15

## Touch Up Paint 4.5 oz. · Pack Quantity: 6



Brown  
TPBR-4

White  
TPWH-4

## Splash Shield™ Aluminum · 2 per pack



White/Brown · Part #: GGWHA · QTY: 10

**End Caps** Pack Quantity: 15



	Galvanized	Royal Brown	White	White Aluminum
4 inch - Left	OG4ECLHG	OG4ECLHBR	OG4ECLHWH	-
4 inch - Right	OG4ECRHG	OG4ECRHBR	OG4ECRHWH	-
5 inch - Left	-	OG5ECLHBR	OG5ECLHWH	OG5ECLHWHA
5 inch - Right	OG5ECHR	OG5ECRHBR	OG5ECRHWH	OG5ECRHWHA

**Tap-In End Caps**

Galvanized Steel  
Pack Quantity: 25

	Part #
5" - R	OG5ECRHTAPG
5" - L	OG5ECLHTAPG
6" - R	OG6ECRHTAPG
6" - L	OG6ECLHTAPG

**Spike & Ferrule**

10 Pack  
Pack Quantity: 12



	Part #
4"-BR	BRS7F4-10PK
4"-GV	GS7F4-10PK
4"-WH	WHS7F4-10PK
5"-BR	BRS7F5-10PK
5"-WH	WHS7F5-10PK

**Screw & Ferrule**

10 Pack  
Pack Quantity: 12



	Part #
5"- BR	BRASR7F5-10PK
5"- WH	WHASR7F5-10PK

**Hidden Hanger**

18 Gauge · with Screw  
Pack Quantity: 100



\* without screw

	Part #
4"	HHOG4G-18
5"	HHOG5G-18
5"	222105*
6"	HAGAH6WOL*

**Fascia Bracket**

4 Pack · Pack Quantity: 12



	Part #
4"-BR	OG4FBBR-4PK
4"-WH	OG4FBWH-4PK
5"-BR	OG5FBBR-4PK
5"-WH	OG5FBWH-4PK

**Strap Hanger**

18 Gauge · 4 Pack



\* QTY: 15 · \*\* QTY: 100

	Part #
4"	GH4G-18-4*
5"	GH5G-18-4*
5"	3H5GKN**
6"	3H6GKSN**

**Gutter Spike**

100 Pack

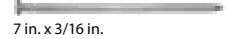

7 in. x 3/16 in.

	Part #
Galvanized	519101

**Ferrules**



\*QTY: 100 · \*\*QTY: 1000

	Part #
4"-GV	GF4EA-100*
6"-BL	FE6BL**

**Wire Strainers**

Size	Part#	QTY
2 inch dia.	CPWSRD2G	25
2 & 3 inch	248070	216



**Silicone Sealant**

Size	Part#	QTY
10.1 oz. Tube	SEAMCA10OZ	12



**Half Round Gutter** 26 Gauge • Single Bead

	With Wing			No Wing		QTY
	Galvanized	Bonderized	Rezibond®	Galvanized	Bonderized	
5 in. x 20 ft.	216106	216751	-	216105	-	6
5 in. x 25 ft.	-	216202	-	-	-	6
6 in. x 20 ft.	216145	216624	216140	216153	-	6
6 in. x 25 ft.	-	216644	216141	-	-	6

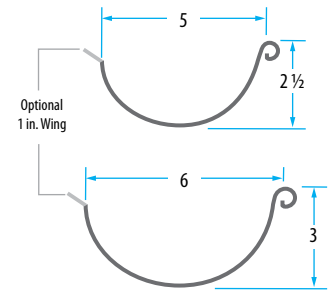

**Half Round End Cap** Galvanized Steel  
Fits both Left & Right



5 inch	QTY	6 inch	QTY
OG5ECHR	30	3EC6GH	100

**Shank & Circle Hanger**  
Fascia Board Mount • Spring Clip Included



5 inch	6 inch	QTY
3SCH5	3SCH6	50

**Cross Bar Hanger**  
Galvanized with 9" or 11" Rods



5 inch Nail	6 inch Nail	QTY
3CS5GHN	3CS6GHN	100

**Downspout - Square** Galvanized Steel • Pack Quantity: 10

Size	Gauge	Galvanized	Bonderized
1-3/4 in. x 2-3/4 in. x 10 ft.	26	237734	237735
1-3/4 in. x 2-3/4 in. x 11 ft.	26	237903	237904
1-3/4 in. x 2-3/4 in. x 11 ft.	28	-	CP13423411B
1-3/4 in. x 2-3/4 in. x 12 ft.	26	237907	237908
1-3/4 in. x 2-3/4 in. x 20 ft.	26	-	237804
2 in. x 3 in. x 10 ft.	28	237736	-
2 in. x 3 in. x 10 ft. - Corrugated	28	CP2310G	-
2 in. x 3 in. x 10 ft.	26	237738	237740
3 in. x 4 in. x 10 ft.	26	237743	237745
3 in. x 4 in. x 20 ft.x	26	-	237746

**Painted Downspout** 28 Gauge • Pack Quantity: 10

Size	Part#
2 in. x 3 in. x 10 ft. - White Aluminum - Corrugated	CP2310WHA
2 in. x 3 in. x 10 ft. - Royal Brown Steel - Corrugated	CP2310BR
2 in. x 3 in. x 10 ft. - White Steel - Corrugated	CP2310WH



Smooth

Corrugated

**Downspout Extension** 2 in. x 3 in. x 15 inch • Pack Quantity: 24

Size	Part#
White Aluminum	CPEXTWHA
White Steel	CP23EXTWH
Royal Brown Steel	CP23EXTBR



**Galvanized Downspout - Round** 10 ft. lengths · Pack Quantity: 10

Size	30 Gauge	28 Gauge	26 Gauge
2 inch	-	CPRD210G	237702
3 inch	-	237704	237705
4 inch	237776	237707	237708
5 inch	-	237711	-



**Bonderized Downspout - Round** Pack Quantity: 10

Size	Part #
2 in. x 11 ft. - 28 Gauge	CPRD211B
3 in. x 10 ft. - 26 Gauge	237790
3 in. x 11 ft. - 26 Gauge	CPRD311B-26



**Downspout Straps** Pack Quantity: 100

Size	Galvanized	Bonderized	QTY
1-3/4 in. x 2-3/4 in. - 26 Ga.	CPS134234G	CPS134234B	100
Flat: 2 in. x 3 in. - 26 Ga.	CPS23G	-	100
Flat: 2 in. x 3 in. - 28 Ga.	CPSF2G	-	50
Flat: 3 in. x 4 in. - 26 Ga.	3PP34G26S	-	50
2 in. Round - 26 Ga.	CPSRD2G	CPSRD2B	50
3 in. Round - 26 Ga.	CPSRD3G	CPSRD3B	100
4 in. Round - 26 Ga.	CPSRD4G	-	50
4 in. Round - 26 Ga.	-	CPSRD4B	100



Size	Royal Brown	White	White Aluminum	QTY
Flat: 2 in. x 3 in.	CPSF2BR	CPSF2WH	CPSF2WHA	50

**Sealant** Titebond® Ultimate MP • 10.1 oz • Pack Quantity: 12

Color	Part #	Color	Part #
Translucent	TB-CL71111	Gray	TB-GR71131
Black	TB-BK71091	Brick Red	TB-RD71211
Cocoa Brown	TB-BN71221	Bronze	TB-BR71121
Bone White	TB-WH71201	Evergreen	TB-GN71191



**Steel Fascia Gutters**



**K-Style Gutters**



3-Way Roof Edge.....	6	FHA Pipe Flashing.....	17	Roll Flashing, Painted Steel .....	14
Access Door, Drywall .....	24	Flat Screen Vent .....	24	Roof Anchors.....	4
Access Door, Ventilating .....	24	Flat Shingles, Galvanized .....	15	Roof Brackets.....	4
Aluminum Louvered Vents.....	24	Flat Shingles, Painted .....	15	Roof Outlet.....	18
Aluminum Mesh.....	21	Flat Stock .....	15	Roof Starter .....	7
Bare Metal Corner Bead .....	32	Flue Guard™, Chimney Cap .....	18	Rooftop Safety Kit .....	4
Bird Stop.....	9	Foam Plugs.....	26	Rooftop Static Vents.....	23
Butyl Tape.....	4	Foundation Vent, Adjustable.....	26	Roof-to-Wall Flashing .....	10
Closure Strips .....	4	Foundation Vent Clips .....	26	Rubber Sleeve Adjustable Pipe Flashing .....	17
Code Caps.....	21	Foundation Vent, Stamped .....	26	Saddle Stock .....	9
Conductor Head .....	34	Gable Louver, Bonderized .....	19	Screw & Ferrule.....	37
Continuous Soffit Vent .....	25	Gable Louver, Copper.....	19	Scupper .....	18
Copper Roll .....	15	Gable Louver, Rectangular.....	19	Seraph Harness .....	4
Corrugated Roofing Panels.....	3	Gable Louver, Round.....	20	Shank & Circle Hanger .....	38
Counter Flashing .....	9	Galvanized Base, Adjustable Pipe Flashing .....	17	Shock Absorbing Lanyard.....	4
Cross Bar Hanger .....	38	Gravel Stop.....	7	Siding Corners .....	13
Damper Doors .....	26	Grip Edge .....	6	Silicone Sealant .....	37
Dormer, Half Round.....	21	Gutter Drop Outlet .....	36	Soffit Vent .....	25
Dormer, Low Profile.....	21	Gutter Spike.....	37	Soffit Vent, Flush Mount .....	25
Dormer, Soft Flange .....	21	Half Round End Cap .....	38	Spike & Ferrule.....	37
Dormer, Sub-Base .....	21	Half Round Gutter .....	38	Splash Shield™.....	36
Downspout Extension.....	38	Hard Plastic Base, Adjustable Pipe Flashing.....	17	Stealth Vent®.....	22
Downspout, Painted .....	38	Hidden Hanger.....	37	Stem Vent, Metal.....	22
Downspout, Round .....	39	HUV Harness.....	4	Stem Vent, Plastic .....	22
Downspout, Square.....	38	J-Vent .....	20	Step Flashing.....	16
Downspout Straps .....	39	K-Style Gutter.....	35	Step Flashing, Painted .....	16
Drip Edge, Bare Metal .....	5	K-Style Gutter Elbows .....	36	Strap Hanger .....	37
Drip Edge, Hemmed.....	6	K-Style Gutter End Caps.....	37	Style-D Eave Drip.....	8
Drip Edge, Painted .....	5	K-Style Gutter End Piece.....	36	Tile Hold Down Clip.....	9
Dryer Cap.....	24	K-Style Gutter Inside Mitre.....	35	Tile Pan .....	8
Drywall Clips.....	27	K-Style Gutter Outside Mitre.....	35	Tile Riser .....	8
Drywall Corner Bead, Tape-On.....	28	K-Style Gutter Slip Connectors .....	35	Titebond® Sealant .....	39
Drywall Furring Hat Channel.....	32	Kwik Mesh™ .....	21	T-Metal .....	7
Drywall L-Trim, Tape-On .....	29	L-Flashing, Bare Metal.....	9	Total JACK™.....	20
Drywall Reveal Trim.....	30	L-Flashing, Painted.....	10	Touch Up Paint .....	36
Drywall Shadow Trim.....	30	Rooftop Safety Lifeline.....	4	T-Top .....	20
Drywall Shims .....	32	Millwork Z-Flashing .....	13	T-Top Sub-Base.....	20
Drywall Squares .....	27	Mini Louver .....	24	Two Way Vent Insert .....	24
Eave Riser.....	8	Moss Control Roll.....	4	Two Way Vents.....	24
Eave Vent .....	25	Norwesco Reversible Vent .....	20	Universal Drop Outlet .....	36
Econo Vent .....	20	Paperfaced Nail-On Corner Bead .....	31	Vent Adapter .....	20
Fascia Bracket.....	37	PBR Panel.....	3	Vent Caps.....	21
Fascia Cap .....	6	Plastic Roof Vent .....	22	Vent Wells, Galvanized .....	27
Fascia Gutter.....	33	Plumber's Flashing.....	18	Vent Wells, Plastic.....	27
Fascia Gutter Elbows .....	34	Pour-In-Place Foundation Vent .....	26	Vulcan Vent®.....	25
Fascia Gutter End Caps.....	34	Rain Diverter.....	27	Wire Strainers.....	37
Fascia Gutter End Piece.....	34	Resilient Furring Channel.....	32	Woodfast Screws .....	4
Fascia Gutter Hangers .....	34	Ridge Cap .....	4	W-Valley.....	11
Fascia Gutter Inside Mitre .....	34	Rim Vent .....	26	Z-Flashing .....	12
Fascia Gutter Outside Mitre .....	34	Roll Flashing, Aluminum.....	14	Zinc Pipe Flashing .....	17
Fascia Gutter Slip Connectors .....	34	Roll Flashing, Galvanized .....	14		
Ferrules .....	37	Roll Flashing, Painted Aluminum.....	14		





# Notes

# GIBRALTAR BUILDING ACCESSORIES DIVISION

*"Provider Of Quality Building Accessories, Built Upon Regional Expertise"*

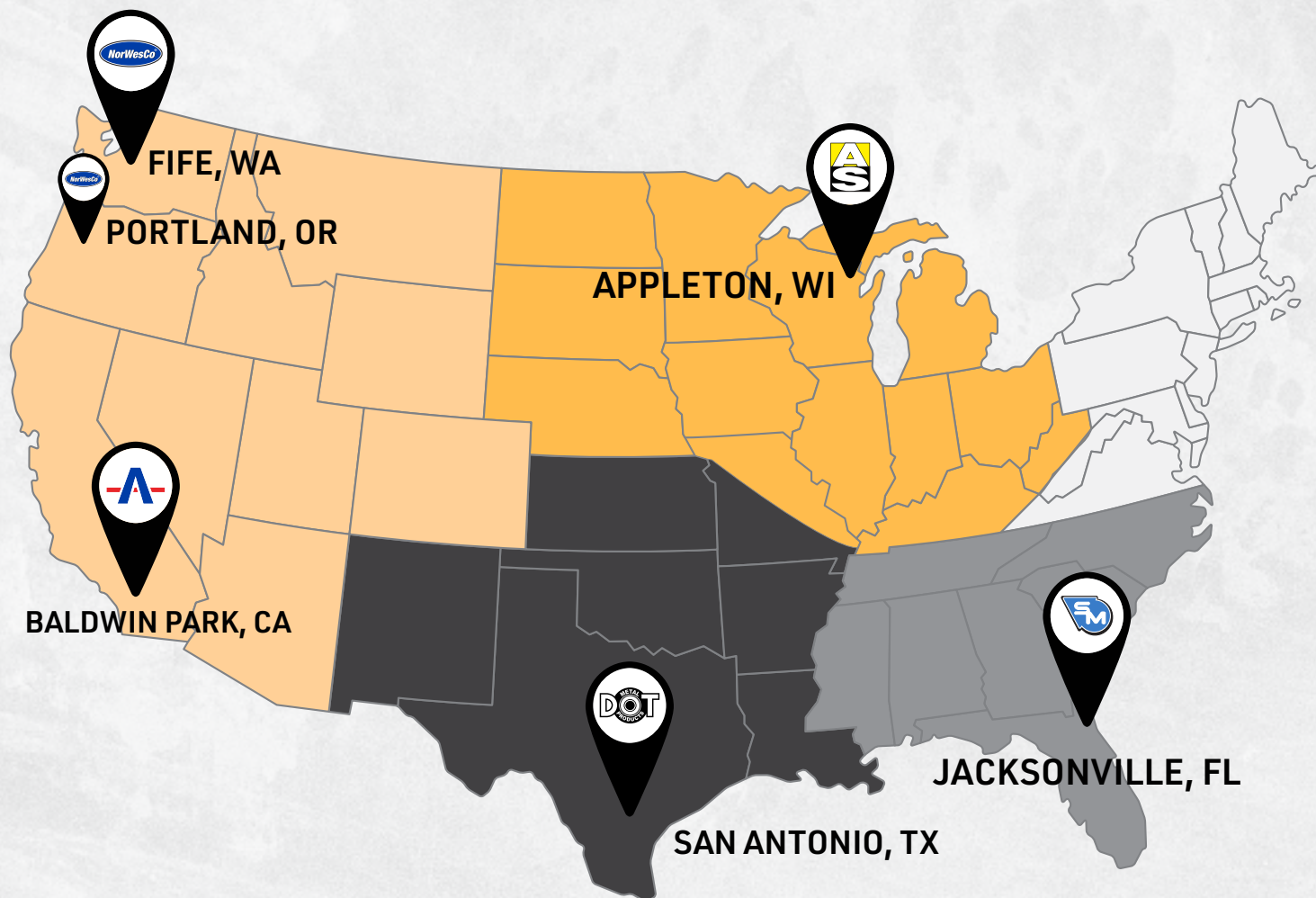

# GIBRALTAR

BUILDING ACCESSORIES DIVISION

SEMCO | DOT | APPLETON | AWARD | NORWESCO

[gibraltarbuildingproducts.com](http://gibraltarbuildingproducts.com)

**Trims & Flashing**  
**Metal Roofing**  
**Ventilation**  
**Drywall Bead**  
**Stucco & Plaster**  
**Soffit & Fascia**  
**Steel Framing**  
**Gutter Protection**  
**Safety Products**



# GIBRALTAR

BUILDING ACCESSORIES DIVISION

SEMCO | DOT | APPLETON | AWARD | NORWESCO

[www.gibraltarbuildingproducts.com](http://www.gibraltarbuildingproducts.com)