

University of Hawai'i Sea Grant College Program

# HOMEOWNER'S HANDBOOK



By  
Dennis J. Hwang  
Darren K. Okimoto

## TO PREPARE FOR NATURAL HAZARDS

Fourth Edition



# Acknowledgements

This handbook would have not been possible without the gracious support of numerous individuals that include: Darren Lerner, Mary Donohue, Cindy Knapman, Heather Dudock, Rachel Lentz, Dolan Eversole, Ruby Pap, Tara Owens, Katy Hintzen, Michael Mezzacapo, Maya Walton, and Diane Sakamoto (University of Hawai'i Sea Grant College Program); Major General Joe Logan, Thomas Travis, Kevin Richards, Arlina Agbayani, and Marsha Tamura (Hawai'i Emergency Mgmt. Agency); Representative Mark Nakashima, Representative Sylvia Luke, Senator Jill Tokuda, and Lori Hasegawa (Hawai'i State Legislature); John Ingargiola, Daniel Bass, Gregory Wilson, Andrew Hereth, Colby Stanton, Lorena Willis, and Gen Tamura (Federal Emergency Mgmt. Agency); Carol Tyau-Beam, Kristen Akamine, Edwin Matsuda, Sam Lemmo, Michael Walker, Rob Hauff, Kirsten Gallaher, and Dietra Myers Tremblay (Dept. of Land and Natural Resources); Leo Asuncion, Justine Nihipali, and Sandy Ma (Hawai'i Office of Planning and Hawai'i Coastal Zone Mgmt. Program); Gordon Ito, Jerry Bump, William Nhie, Jacqueline Choy, and Chanel Honda (State of Hawai'i Insurance Division); Tim Waite, Joel Frenzel and Will Becker (Simpson Strong-Tie Company); Gary Chock (Martin & Chock, Inc.); Coralie Chun Matayoshi and Maria Lutz (American Red Cross); Gordon Alexander (Hurricane Secure); Alan Oshima, Scott Seu, Darcy Endo-Omoto, Lori Hoo, Ka'iulani DeSilva, Ka'anoi Clemente, Tatiana Quong, Sam Nichols, and Wanya Ogata (Hawaiian Electric); Richard Wacker, Beth Whitehead, and Michelle Bartell (American Savings Bank); Bob and Pam Barrett (Coastal Windows); Hirokazu Toiya, Jennifer Walter, Crystal Van Beelen, and John Cummings (Dept. of Emergency Mgmt., City and County of Honolulu); Joshua Stanbro, Justin Gruenstein, and Matthew Gonser (Office of Climate Change, Sustainability, and Resiliency, City and County of Honolulu); Herman Andaya, Chaman Carroll, and Misty Cordeira (Maui Emergency Mgmt. Agency); Talmadge Magno, John Drummond, and Barry Perriatt (County of Hawai'i Civil Defense Agency); Marlene Murray (Pacific Tsunami Museum); Elton Ushio and Chelsie Sakai (Kaua'i Emergency Mgmt. Agency); Christopher Brencley, Tom Evans, John Bravender, Kevin Kodama, and Eric Lau (NOAA National Weather Service); Charles McCreery, Stuart Weinstein, and Cindi Preller (Pacific Tsunami Warning Center); Karl Kim, Russell Uyeno, Eric Yamashita, Lydia Morikawa, Rob Porro, and Pradip Pant (National Disaster Preparedness Training Center); George Curtis (UH and Hawai'i Tsunami Advisor); Daniel Walker (UH and Department of Emergency Mgmt. of the City and County of Honolulu Tsunami Advisor); Walter Dudley and Don Thomas (UH Hilo); Clay Trauernicht (UH Coop. Ext.); Christina Neal, Brian Shiro, James Kauahikaua, Paul Okubo, and Janet Babb (USGS - Hawaiian Volcano Observatory); Timothy Johns and Leslie Door (Zephyr Insurance Company); Daniel Losk (State Farm); Samantha Cherry (ICAT); Bob Bruhl, Alan Labbe, Mary Flood, and Tracy Tonaki (D.R. Horton); Gerald Peters (HPS - Hurricane Protection Services); Ian Robertson (Hawai'i State Earthquake and Tsunami Advisory Committee); Gerard Fryer (Hawai'i Institute of Geophysics & Planetology); Mike Ward (Aloha Power Equipment); Laura Kong (International Tsunami Information Center); Christopher Conklin (Federal Executive Board); Gladys Quinto Marrone, Barbara Nishikawa, and Carolyn Hyman (Building Industry Association of Hawai'i); Bernard and Randall Balais (West O'ahu Roofing); Jerry Griffin (Discount Windows); Dave Purington and Makoto Nakamura (Hardware Hawai'i); and Elizabeth Pickett, Carson Magoon, and Pablo Beimler (Hawai'i Wildfire Management Organization).

It is our hope that the information contained within the handbook, which is in part a compilation from numerous publications associated with natural hazards and hazard mitigation, will be widely used and adopted by stakeholders in Hawai'i and the region.

Financial support for the handbook was generously provided by the University of Hawai'i Sea Grant College Program, Hawai'i State Legislature, Hawai'i Emergency Management Agency, State Farm, D.R. Horton, Hawaiian Electric, Simpson Strong-Tie Company, Zephyr Insurance Company, ICAT, Department of Land and Natural Resources, the Hawai'i Coastal Zone Management Program, City and County Office of Climate Change, Sustainability, and Resiliency, West O'ahu Roofing, Coastal Windows, Hardware Hawai'i, and Discount Windows whom we gratefully thank.

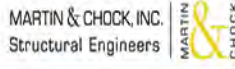

HAWAII

# HOMEOWNER'S HANDBOOK TO PREPARE FOR NATURAL HAZARDS

By  
**Dennis J. Hwang**  
**Darren K. Okimoto**



September 2019  
Published by the University of Hawai'i  
Sea Grant College Program  
Fourth Edition, Version 4.0

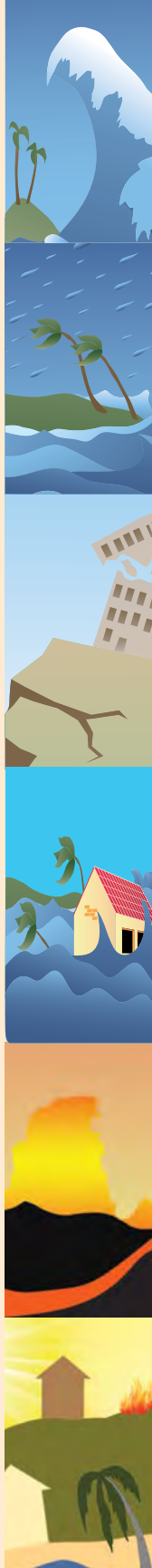

# Contents

<b>Part 1 Introduction</b> .....	<b>1</b>
1.1 Common Myths and Reasons to Prepare.....	3
1.2 Ten Things Homeowners Can Do to Prepare.....	8
<b>Part 2 Natural Hazards: An Overview for Homeowners</b> .....	<b>12</b>
2.1 Tsunami Hazards in Hawai‘i.....	12
2.2 Hurricane Hazards in Hawai‘i.....	15
2.3 Earthquake Hazards in Hawai‘i.....	21
2.4 Flood Hazards in Hawai‘i.....	23
2.5 Volcano Hazards in Hawai‘i.....	25
2.6 Climate Change in Hawai‘i.....	29
2.6.1 Drought.....	29
2.6.2 Wildfire.....	30
2.6.3 Extreme Heat.....	32
2.6.4 Infectious Disease.....	32
2.6.5 Sea-level Rise.....	33
2.6.6 Beach Erosion.....	34
<b>Part 3 Protecting Yourself and Your Family</b> .....	<b>36</b>
3.1 Emergency Supplies.....	36
3.2 Evacuation Kit.....	39
3.3 Evacuation Planning.....	40
3.3.1 Key Definitions.....	42
3.3.2 Emergency Alert System.....	44
3.4 Evacuation Plan for a Tsunami.....	46
3.5 Preparations Before a Hurricane.....	53
3.6 Evacuation Plan for a Hurricane.....	54
3.7 Evacuation Procedures for a Flood.....	60
3.8 Evacuation Procedures for an Earthquake.....	60
3.9 Summary.....	61
<b>Part 4 Protecting Property</b> .....	<b>63</b>
4.1 Concept 1: Continuous Load Path Connection.....	66
4.1.1 Guide to Installing the Hawai‘i Plantation Tie Hurricane Clip.....	72
4.1.2 Wall-to-Foundation Connection.....	76
4.1.3 Continuous Load Path for Double-Wall Houses.....	80
4.2 Concept 2: Creating the Wind- and Rain-Resistant Envelope.....	87
4.3 Window Coverings.....	88
4.3.1 Roll-down Shutters.....	88
4.3.2 Bahama Shutters.....	89
4.3.3 Colonial Shutters.....	90
4.3.4 Accordion Shutters.....	90
4.3.5 Storm Panels.....	91
4.3.6 Impact-Resistant Glass Systems.....	92

4.3.7 Laminates.....	93
4.3.8 Hurricane Mesh, Screen, or Fabric.....	94
4.3.9 Plastic Honeycomb Panels.....	95
4.3.10 Plywood Shutters.....	95
4.4 Installing Plywood Shutters.....	98
4.4.1 Obtaining Assistance.....	98
4.4.2 Material to Use.....	98
4.4.3 Measuring the Windows and Cutting the Plywood.....	99
4.4.4 Fasteners and Attaching the Panels.....	101
4.4.5 Deployment.....	102
4.4.6 Other Methods of Installation.....	103
4.4.7 Simpson Strong-Tie Storm Panel Screws.....	104
4.4.8 Larger Windows.....	107
4.4.9 Storing Plywood Panels.....	109
4.4.10 Timing Deployment with a Hurricane Watch or Warning.....	109
4.5 Other Wind-Resistive Device Retrofits.....	110
4.6 Roofing.....	112
4.6.1 Ridge Vents.....	118
4.6.2 Truss Bracing.....	120
4.7 Solar Photovoltaic.....	123
4.8 Exterior Opening Protection (Garage and Doors).....	128
4.9 Safe Room.....	130
4.9.1 The Safe Room: Tax Credits and Cost.....	130
4.10 Trees.....	131
4.11 Earthquake Retrofit.....	132
4.12 Flood Retrofit.....	133
4.13 Wildfire.....	134
4.14 Electrical Issues for the House.....	135
4.14.1 Energy Efficiency.....	136
4.14.2 Generators.....	138
4.14.3 Power Stations.....	139
4.15 Licensed Contractors.....	140
<b>Part 5 Protecting Property with Insurance.....</b>	<b>142</b>
5.1 Hurricane Insurance.....	142
5.1.1 Insurance Discounts for Installation of Hurricane Protection.....	144
5.2 Flood Insurance.....	145
5.3 Earthquake Insurance.....	146
5.4 Miscellaneous Insurance Issues.....	147
Appendix A Emergency Contacts.....	148
Appendix B Resilience, Adaptation, and Sustainability.....	149
Appendix C Working with the Community.....	151
Appendix D After the Storm.....	154
Useful Links.....	156
Reference Links.....	158
Endnotes.....	163

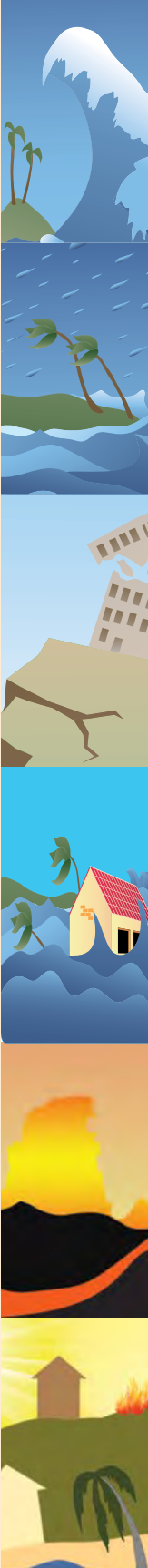



# Part 1

## Introduction

Your home is your castle. It protects you and your family, as well as your worldly possessions, from the elements. For many, the home is also a major investment. Yet natural hazards such as tsunamis, hurricanes, floods, earthquakes, or other hazards can threaten both inhabitants and home contents. When a natural hazard occurs, the results can be devastating.

This handbook was created to help homeowners prepare for a natural hazard so that risks to family and property may be reduced. While it is never possible to eliminate all damage from a natural hazard, homeowners can take action and implement many small and cost-effective steps that could significantly lower risk. Mother Nature can be intense. Your family and home deserve the protection that only you can provide.

This handbook is divided into five parts and appendices.

Part 1 presents the purpose and layout of the handbook, and includes a discussion of common myths that may have prevented you from taking action. A summary of the content of this handbook is provided in the form of key action items to protect your family and property.

Part 2 provides basic information on tsunamis, hurricanes, earthquakes, floods, volcanoes, and climate change. The climate change section discusses existing hazards which are expected to worsen as the earth warms, such as drought, wildfire, extreme heat, infectious disease, sea-level rise, and beach erosion. This information will help explain the significant risks of these hazards in Hawai'i and why simple steps should be taken now to prepare.

Part 3 discusses how to protect yourself and your family. Included in this section are the 14-day stock of essential emergency supplies, an evacuation kit, evacuation procedures, and emergency planning. The emergency planning covers evacuation for a hurricane and a tsunami. They are different, so it is important that residents do not get the emergency procedures for the different threats confused. Understanding this

distinction can save lives. For a tsunami, evacuation is necessary to avoid the water. For a hurricane, evacuation may be necessary to avoid either water or high winds.

Part 4 covers how to protect your property. Many simple examples are provided that the homeowner or a licensed contractor can do. The emphasis is on protection from a hurricane, which is the major threat identified on all islands. Some best practices for floods, earthquakes, and wildfires are also provided.

Part 5 reviews the important topic of insurance. No matter how strong or prepared a home or homeowner is, there is always the risk of damage that cannot be avoided. This is why flood insurance under the National Flood Insurance Program or hurricane wind insurance play a role. Other types of insurance are also covered.

The following topics are covered in the appendices:

Appendix A - Emergency Contacts

Appendix B - Resilience, Adaptation, and Sustainability

Appendix C - Working with the Community

Appendix D - After the Storm

This handbook is available for free as a downloadable pdf file at the University of Hawai‘i Sea Grant College Program website: [hawaii.seagrant.org](http://hawaii.seagrant.org). Always go to this website for the most recent version of this book as it will be updated more often than printed. In addition, related material will be on the website which cannot always fit within the confines of this handbook.

The latest preparation and emergency information should be available at your state or county emergency management or civil defense agencies' website. The addresses and contact numbers are provided in Appendix A. New information is always coming online, so you should visit these websites at least annually to stay informed.

There are many links that have been referenced throughout this book (e.g., see Reference Link 1, 2, 3, etc.). They can be found in the Reference Link section on page 158 (where they are active in the digital version).

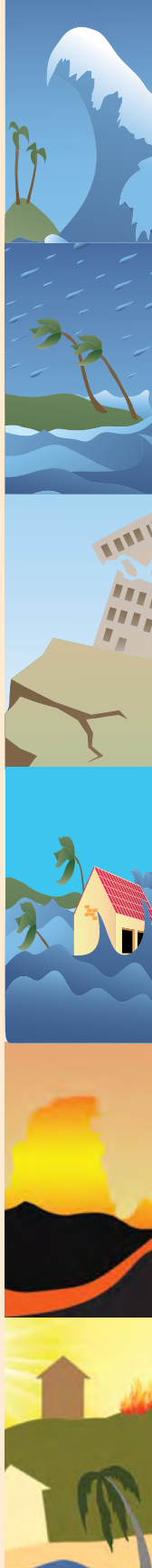



## 1.1 Common Myths and Reasons to Prepare

Many homeowners in Hawai‘i have not fully prepared for a natural hazard because of complacency caused by several myths. The most common myths are discussed below in order to remove some of the barriers to taking action and to encourage people to prepare.

### 1) “A natural hazard can’t happen to me.”

Scientists agree that it is not a matter of IF the next tsunami or hurricane will occur, but WHEN. From 1819 to 1975, Hawai‘i experienced at least 26 damaging tsunamis, or about one every six years.<sup>1</sup> After 1975, there were no damaging tsunamis in the islands, until those associated with the Chile earthquake in 2010 and the Japan earthquake in 2011. Still, the damage in Hawai‘i from these tsunamis was relatively minor compared to historical events. This long period of relative inactivity from 1975 to the present is unlikely to continue.

Regarding hurricanes, the National Weather Service expects an event to impact the islands about once every 15 years. There is a good chance that a major event will occur during your lifetime. Hawai‘i was very fortunate in 2015 that despite a record number of 16 tropical cyclones in the Pacific, all missed the state. It was also the first time that there were three Category 4 hurricanes in the central and eastern Pacific at the same time. Hawai‘i was similarly fortunate during the busy hurricane seasons of 2014 and 2016. Much of the tropical cyclone activity in the Pacific is related to El Niño and La Niña cycles. Conditions favorable for hurricane formation in the Pacific are often unfavorable for the Atlantic and vice versa. In 2017, there was record hurricane activity and damage in the Atlantic with Hurricanes Harvey, Irma, and Maria, while the Pacific was relatively quiet, compared to 2014 through 2016. However, this can easily reverse as an El Niño occurs every two to six years. The weak El Niño that has characterized 2019 has been forecast to bring an associated weak increase in hurricane activity.

### 2) “If a hazard occurs, it won’t be that bad.”

When a tsunami or hurricane occurs, the damage can be devastating. When Hurricane Iniki struck Kaua‘i in 1992, more than 41 percent



of the island’s 15,200 homes were damaged or destroyed (1,100 were destroyed; about 1,000 suffered severe damage; 4,200 suffered moderate to minor damage).<sup>2</sup> More than 7,000 residents were left homeless.<sup>3</sup> Damage could have been much worse if Iniki had struck the islands of Hawai‘i, Maui, or O‘ahu, which have approximately two to eight times more residential properties.<sup>4</sup> It is also conceivable that a single hurricane can strike more than one island. In 2014, two days before Hurricane Ana passed the islands, the National Weather Service projected a path with the most damaging right-front quadrant of the hurricane hitting Hawai‘i, Maui, and then O‘ahu. In 2017, Hurricanes Harvey in Texas, Irma in Florida, and Maria in Puerto Rico, as well as the wildfires in California provided important lessons on how damaging a hazard can be. During the record floods on Kaua‘i and O‘ahu in April 2018, over 300 homes were damaged or destroyed. For the three months of volcanic activity on Hawai‘i County, beginning on May 3, 2018, lava destroyed over 700 homes. This fourth edition of the handbook incorporates many lessons learned from these hazards and how we can best prepare.

### 3) **“I survived Hurricane Iniki so I am sufficiently prepared.”**

Many people outside of Kaua‘i have the impression that they survived Hurricane Iniki, and therefore they do not need to prepare any more than they did in 1992. Only Kaua‘i received the full force of the winds, rain, and high surf from Hurricane Iniki.

### 4) **“Hurricanes only hit Kaua‘i so those on the other islands don’t need to prepare.”**

It is a myth that only Kaua‘i will be hit by a hurricane. While the most recent hurricanes hit Kaua‘i (‘Iwa in 1982 and Iniki in 1992) other hurricanes or cyclonic storms have impacted the other islands at various points in history. For example, Nina damaged O‘ahu in 1957, and, according to the National Weather Service, a major hurricane hit Maui and Hawai‘i in 1871. Also, there have been many close misses, both historically and recently. Most scientists agree that all the islands are at equal risk from a hurricane.

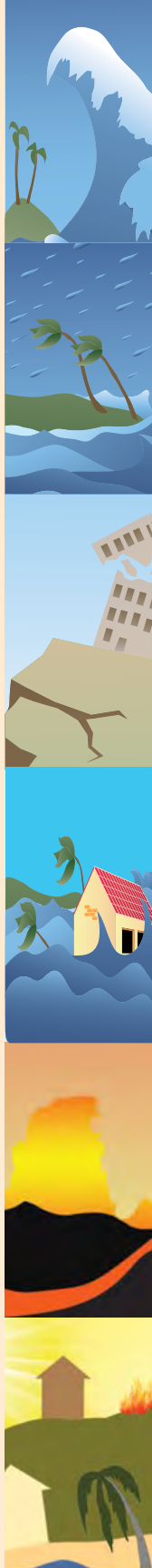



5) **“I don’t live near the coast, so I am safe.”**

In fact, the vast majority of damage or destruction on Kaua‘i by Iniki was caused by the powerful winds of the hurricane.<sup>5</sup> Therefore, all homeowners should prepare, not just those along the coast.

6) **“Installing hurricane clips doesn’t guarantee there will be no damage after a hurricane, so I won’t bother.”**

Even though someone may wear a seat belt, shoulder belt, and have an airbag, there is no guarantee that people will not be injured in a major auto accident. Yet most people recognize the importance of these safety devices in reducing risk, and they use them. Likewise, the measures discussed in this handbook could significantly reduce risk, although there are no guarantees there will be no damage. This edition of the handbook includes many new options to make single-wall and double-wall homes stronger. Almost every house in Hawai‘i can be strengthened.

7) **“If a natural hazard occurs, the government will come to the rescue.”**

After the earthquake on October 15, 2006, and the volcanic activity in 2018, many homeowners on the island of Hawai‘i found that the government will not repair or replace their damaged or destroyed homes or even provide adequate compensation. It is up to the homeowner to plan properly by strengthening their house and to have the appropriate financial protections in place, such as insurance, if it is available. After a natural hazard, the government may also be overwhelmed by the number of people in need.

8) **“My home in Hawai‘i County survived the October 15, 2006 earthquake, so I do not need to retrofit for earthquakes.”**

The ground shaking on all the islands during the October 15, 2006 event was significantly lower than the force exerted by an earthquake that would cause damage to homes built to the current building code specifications. If and when a stronger earthquake occurs, the resulting damage to homes will be much greater. Homeowners in Hawai‘i County should consider retrofits that provide a continuous load path connection, which will help protect homes against both hurricanes and earthquakes.

## 9) “Earthquakes only affect Hawai‘i County, so I don’t need to worry.”

Although earthquakes affecting the island of Hawai‘i are more frequent and likely to be larger, there is still a significant seismic hazard for Maui County and the island of O‘ahu. Fortunately, many of the measures to protect a home against a hurricane in Maui County and O‘ahu can also protect against an earthquake. Residents of Hawai‘i County may need additional measures.

## 10) “Even if a hazard occurs, there is nothing I can do.”

Fortunately, there are many small steps that can be taken to significantly reduce the risk of damage to life and property. The number of options available to homeowners has never been greater. While it is not possible to eliminate all risk or damage, many reasonable steps as described in this handbook to plan and prepare can make a major difference and can determine whether a house survives and receives only minor or no damage. Thus, the information in this handbook covers two major parts for preparation: (i) protecting yourself and your family, and (ii) protecting your property.

## 11) “Strengthening my home is too expensive and not worth the effort.”

The most important function of a home is to provide protection from normal conditions and extreme ones. Here are various cost-effective ways to strengthen a home’s structure:

- Adding hurricane clips or window coverings offers significant protection alone and runs on the order of a few thousand dollars.
- There are new methods to strengthen double-wall houses without hurricane clips or a continuous load path by tying the roof to the foundation with structural screws.
- Strengthening the roof structure (trusses and rafters) with bracing can be done at a minimal cost.
- One of the most vulnerable parts of the home is the roof. While strengthening an existing roof can be expensive, consider doing so

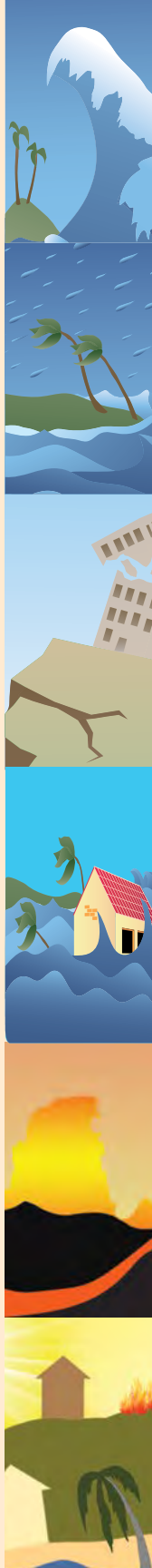

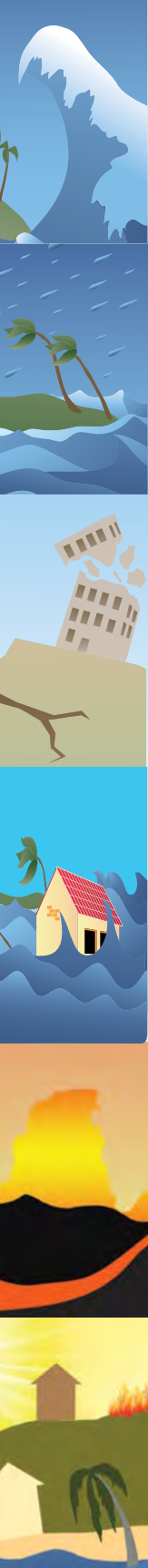

when replacing an old roof at the end of its life with a new one, as the additional cost is very reasonable. Many options in the fourth edition of the handbook are provided to strengthen the roof during re-roofing or independent of re-roofing. Many homeowners who install solar panels re-roof beforehand, and this is a good time to strengthen the roof (see Parts 4.6 and 4.7).

- In many situations, upgrading the house foundation can be very cost effective. This edition of the handbook covers simplified measures to strengthen the many single-wall houses on post and pier foundations with tofu blocks. With new connectors now available, the retrofit is easier than ever.

Many upgrades can be offset with insurance premium discounts. Ultimately, the time and money spent preparing a home to minimize damage from a natural hazard are a tiny fraction of what might need to be spent if major damages occur as a result of a failure to take preventative measures.

By preparing and strengthening your home, you may be able to shelter in place when a hurricane nears, rather than evacuate to a shelter. Evacuation to a public shelter should be the last resort. There will be minimal supplies, the simplest of sanitary facilities, a bare floor, and little space (10 square feet per person - 5 feet by 2 feet). Evacuees must bring their own supplies including bedding, medication, food, and water. By remaining at home during a hazard, you will be in far more comfortable conditions and have the ability to take better care of family members, including the elderly, those with special needs, and pets. The ability to shelter in place depends on numerous factors, including original house design, retrofits installed, the strength of the hazard event, and the risk of flooding (see the Shelter-in Place Table – Part 3.6). Nevertheless, by strengthening your home you protect your neighbors as well as yourself. A home that falls apart during a hurricane will create debris that can damage adjacent properties.

## 1.2 Ten Things Homeowners Can Do to Prepare

As covered in later parts of this handbook, here are ten preparation items that will provide greater protection for your family and property.

### 1) Gather emergency supplies now.

The good news is that many necessary items are probably in your home already (see Part 3). Check and restock each month so that the supplies are complete, not outdated, or used. Expiration dates, which are hard to read because of small print, can be made more visible on the packaging with an indelible ink pen, such as a Sharpie. Avoid rushing to a store during an emergency to gather supplies. There will be long lines and empty shelves, so try not to add to the crowd and confusion. During the approach of Hurricane/Tropical Storm Iselle in 2014, many stores were out of water, gas, and other supplies two or three days before expected landfall. The new guidance is for a family to have a 14-day supply of emergency food and water. Tips for gathering supplies are provided in Part 3.1.

### 2) Compile an evacuation kit.

If your evacuation plans include using a public shelter for a hurricane, prepare an evacuation kit that contains water, food, clothing, medications, personal hygiene products, and other items. The kit should already be assembled and checked before hurricane season and can be used for evacuation for other hazards such as a tsunami, wildfire, or lava flow (see Part 3.2).

### 3) Create separate evacuation plans for a tsunami and hurricane. They are different.

**For a tsunami**, evacuation is necessary because of the sudden influx of water. Evacuate to high ground outside the applicable evacuation zone, if necessary. Consult websites of the local emergency management or civil defense agency (Appendix A) to determine the locations of evacuation zones. There are now two evacuation zones for all counties except Hawai'i County, one for a normal tsunami based off of historical tsunamis experienced in the state, and one for an extreme tsunami event (put in after the mega-tsunamis in the Indian Ocean in 2004 and the Japan tsunami in 2011). Only evacuate to the evacuation

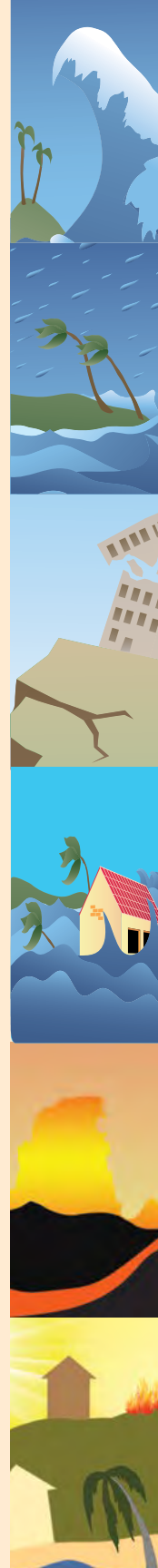

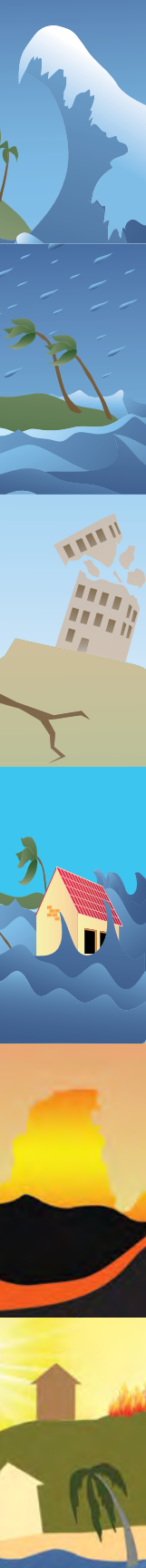

zone if: (i) there is an earthquake strong enough to prevent standing, or (ii) there is appreciable earthquake shaking **and** the siren sounds a few minutes later, or (iii) you are instructed by local radio and television to evacuate. **If there is no shaking, the siren means to turn on local radio and TV.** Be aware that the wait may be many hours after evacuation (see Part 3.4 for additional guidance).

**For a hurricane**, it is necessary to evacuate because of water from storm surge or flooding from excessive rain, and possibly from high winds. Your plan may include sheltering at home if it is: (i) sufficiently strong for the wind (i.e., built with strong connectors - see Shelter-in-Place Table – Part 3.6), (ii) outside a storm surge zone (new hurricane storm surge maps are currently online); and (iii) outside any high-risk flood zone (see Part 2.4 on Flood Hazards in Hawai‘i to determine whether your property is in in a high-risk flood zone). If your house is not suitable for sheltering, use a suitable alternative structure (a friend or relative’s house) or **a shelter that is officially open (listen to local radio and television)** (see Part 3.6 for more guidance).

Discuss and practice drills of your evacuation plan with your family every year. The drill should cover, at the minimum, a tsunami and a hurricane.

#### 4) **Know your property and take appropriate action.**

Consider your property’s location. If the land floods, consider flood insurance, even if it is not in a high risk flood zone. If trees overhang the house, consider trimming or cutting the branches overhead which may damage your home in a storm. If the property is near a ridge, it may be especially susceptible to wind damage during a storm or hurricane. Identifying risky characteristics of your property can help determine the most effective measures to strengthen the structure (see Part 4) and whether purchasing insurance is necessary (see Part 5).

#### 5) **Know your home and take appropriate action.**

When was your home built? Does it have connectors to tie the roof to the wall or the wall to the foundation? When will you need to re-roof? Look at your blueprints. They may be available from your homebuilder, your local building department, or your architect (see Part 4).

## 6) Strengthen your home.

A home built after the early to mid-1990s should have hurricane clips to tie the roof to the wall and strong connectors from the wall to the foundation. This is called a continuous load path connection (see Part 4). If your home was built before then, it probably does not have the connection, but they can be retrofitted at a reasonable cost. This book has many retrofit options to complete the load path for single-wall and double-wall homes. Even if the entire load path cannot be completed during retrofit, the home is strengthened by completing the load path as much as possible from the top down. All households should also consider the many options now available to protect windows, garage, and doors. It is also possible to strengthen a roof without a full re-roofing, although that is the best time for the additions if the roof does need replacing. The steps a homeowner can take will vary with each home, but for the majority of homeowners, there are many steps to take that can significantly strengthen a house, no matter what the age (see Part 4).

## 7) Insurance and potential discounts.

No matter how strong the house, there is always residual risk. Don't gamble with your home. Obtain adequate insurance for a hurricane, flood insurance if in a flood-prone area, and earthquake insurance if appropriate and available (see Part 5). Take advantage of any potential discounts to insurance premiums for measures that reduce risk. Coverage will vary among insurance companies, so call your insurance agent to find out about discounts that may be available. Significant discounts in hurricane insurance may be provided for reducing the risk with window protection, roof-to-wall tie-downs (hurricane clips), and wall-to-foundation tie-downs (see Part 5).

## 8) Invest in your house and family.

Consider efforts to strengthen a home as the most important home improvement project. Most projects are not that expensive. For the more costly ones, a small home improvement loan and potential discounts from hurricane insurance premiums make these projects within reach. It is the best investment to strengthen your home and provide more protection to your family (see Part 4).

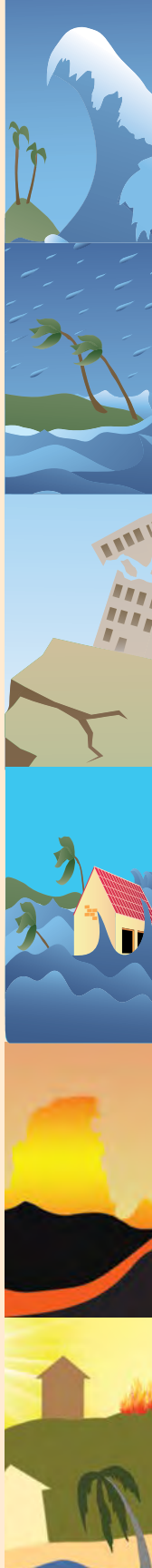

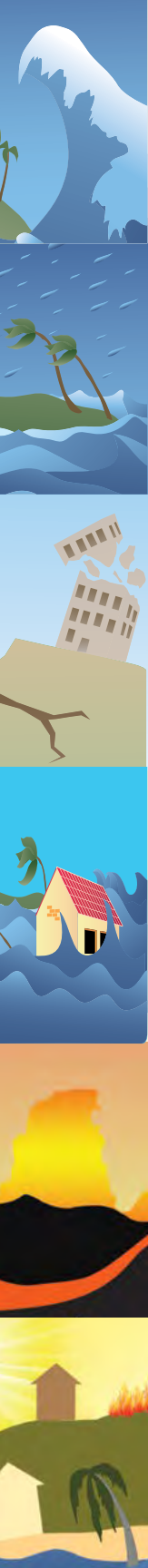

**9) Seek the assistance of a qualified, licensed architect, structural engineer, or contractor.**

This handbook covers work that homeowners may be able to do themselves. If this is not possible, seek qualified assistance through trusted references from friends and family, the Structural Engineers Association, county civil defense and emergency management agencies, or the local contractor's associations. Even if you do the work yourself, it is always best to seek professional advice from a licensed architect or structural engineer for initial guidance since every home is a little different.

**10) Be resilient, adaptive, and sustainable.**

For the most part, the goals of being resilient to hazards, adaptive to climate change, and environmentally sustainable reinforce each other. For example, reducing water and energy use to preserve the environment and mitigate climate change helps a family during a hazard cope when services may be down. Adding solar panels to a roof are sustainable and adaptive measures but can also add to resiliency if the panels are installed to resist uplift from hurricane winds and then can supply backup power during power outages after a storm. Many resilient, adaptive, and sustainable measures are now incorporated into the 4<sup>th</sup> Edition of this Handbook. Homeowners should utilize these measures to be more resilient while improving their community.



# Part 2

## Natural Hazards: An Overview for Homeowners

In Hawai‘i, many different types of natural hazards can occur. This handbook initially concentrated on hurricanes, tsunamis, floods, and earthquakes, the most potentially devastating hazards in terms of loss of life and property damage. This book now covers volcanoes and many hazards associated with climate change. While hazards such as erosion, sea-level rise, heat, wildfire, and drought exist without climate change, the warming Earth will exacerbate their impacts, and thus they are covered in the climate change section.

Preparing for the larger hazard events (hurricanes, tsunamis, earthquakes, and flooding) will offer protection from the smaller, more frequent events. There is much more information on these hazards than can be provided in this handbook. Included here is only basic information that may play a role in how homeowners can prepare for these hazards.

### 2.1 Tsunami Hazards in Hawai‘i

A tsunami is a series of traveling ocean waves generated primarily by earthquakes occurring below or near the ocean floor. Not all underwater earthquakes will create a tsunami, but if the motion of the seafloor is more vertical than horizontal, a tsunami is more likely to be generated. Underwater volcanic eruptions and landslides can also generate tsunamis.<sup>6</sup>

In the open ocean, the tsunami travels at great speed (about 500 miles per hour) and has a wave height of only one foot or less. As the tsunami approaches shallow coastal waters, the waves slow down and the water piles up to form a wall that can be more than 30 feet high.

A tsunami has great destructive power. Given the proper coastal configuration, water from a tsunami can penetrate several thousand feet inland (see Figure 2-1).<sup>7</sup> This destructive power demands great respect. It

is necessary for all residents to plan properly for evacuation from a tsunami (see Part 3).



**Figure 2-1. Inundation from the 1946 tsunami in Hilo reached several thousand feet inland. This photo depicts the tremendous power of a tsunami. Taken from the Hilo Tribune-Herald. Photo courtesy of Pacific Tsunami Museum–Andrew Spaulding Collection.**

There were 26 damaging tsunamis around the islands between 1819 and 1975, or about one every six years.<sup>8</sup> Since 1975, there had not been a major damaging tsunami until the Japan earthquake of March 11, 2011 which caused catastrophic devastation in Japan and over 30 million dollars in property damage around the state.<sup>9</sup> The long period of tsunami inactivity from 1975 until 2010 and 2011 was unusual when compared to the historical record. Thus, it is important to prepare for the tsunami hazard, which could occur at any time in the future.

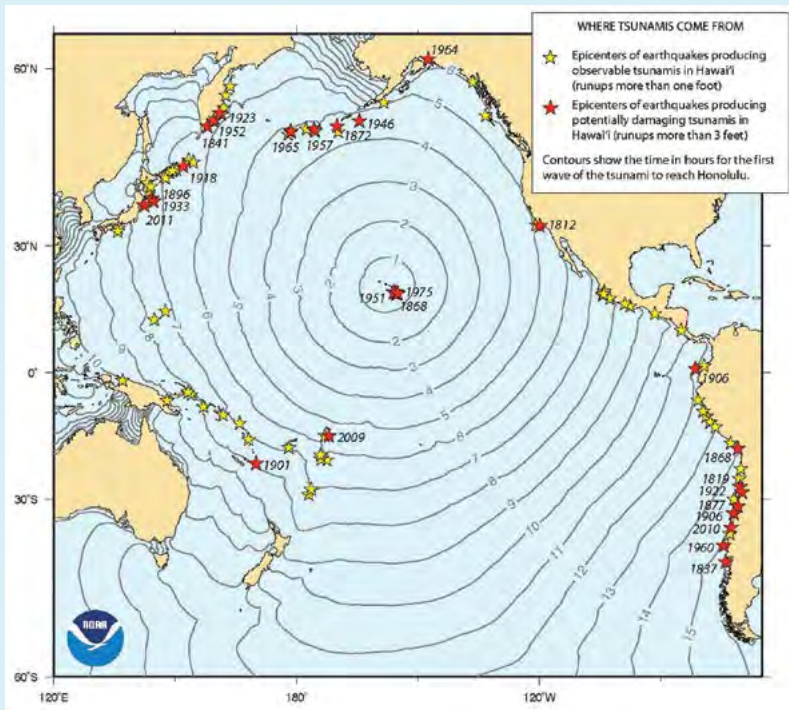

Figure 2-2. Travel times to Hawai‘i in hours from various earthquake locations around the Pacific Rim. Note travel times for the 1946 earthquake near Alaska (4.5 hours), the 1960 and 2010 earthquakes off Chile (15 hours), and the 2011 earthquake off Japan (7.5 hours). Locally generated tsunamis caused by earthquakes in 1868, 1951, and 1975 are also marked. Compiled by Gerard Fryer of the Pacific Tsunami Warning Center.

**Table 2-1. Travel Times from Various Potential Sources of a Tsunami**

Some Possible Sources	Destination	Tsunami Travel Time
South America (example, 1960 and 2010 Chile earthquakes)	State of Hawai‘i	15 hours
Japan (example, 2011 Japan earthquake)	State of Hawai‘i	7.5 hours
Alaska (example, 1946 Aleutian earthquake)	State of Hawai‘i	4.5 hours
Local Earthquake, Hawai‘i County	Kaua‘i	40 minutes
Local Earthquake, Hawai‘i County	O‘ahu	25 minutes
Local Earthquake, Hawai‘i County	Maui	15 minutes
Local Earthquake, Hawai‘i County	Hawai‘i County	5 minutes or less

Response will differ if there is a distant tsunami or a locally generated one. According to the Pacific Tsunami Warning Center, it will take about three minutes to analyze an earthquake, determine if a potentially damaging tsunami has been generated, and sound the siren.<sup>10</sup> However, from the table on the preceding page, we learned that if there is a local earthquake near Hawai‘i County, a wave may reach the coastline there in five minutes or less. If there is an earthquake strong enough to interfere with the ability to stand upright, a local tsunami may have been generated, and it is necessary to evacuate inland to high ground immediately. Do not take the time to check the phone book or listen to the radio. The wave may come before the sirens can sound and before a radio message to evacuate can be issued (see Part 3).

Once a tsunami reaches the Hawai‘i coastline, it may take many hours for the series or train of waves to pass the islands.

## 2.2 Hurricane Hazards in Hawai‘i

Tropical cyclones consist of tropical depressions, tropical storms, and hurricanes. Before a system becomes a hurricane in tropical waters near Hawai‘i, it starts out as a tropical depression, develops into a tropical storm, and intensifies into a hurricane. A hurricane is an intense tropical weather system with a well-defined circulation pattern and maximum sustained winds of 74 miles per hour or more. In contrast, a tropical storm, which is also an organized weather system with well-defined circulation, has maximum sustained winds between 39 and 73 miles per hour. A tropical depression is a low-level circulation system of persistent clouds and thunderstorm with maximum sustained winds of 38 miles per hour or less. While far less powerful than hurricanes, tropical storms and tropical depressions can still cause substantial damage. After a hurricane weakens and dissipates in tropical waters, it reverts to a tropical storm and eventually to a tropical depression.

Hurricane strength is often given in categories using the Saffir-Simpson Hurricane Scale, which rates hurricanes from 1 to 5 based on the intensity of the sustained winds. During a hurricane, there is a triple threat of damage from high winds, very high surf, and flooding associated with



heavy rains. Table 2-2 shows expected wind-related damages from the different hurricane categories.

One misperception around the state is that a hurricane will only strike Kaua‘i and, therefore, residents of the other islands do not need to prepare. This is based on the impacts to Kaua‘i from Hurricanes Dot (1959), ‘Iwa (1982), and Iniki (1992). However, in 1957 damage occurred on O‘ahu from Hurricane Nina, and the National Weather Service has records that indicate a major cyclonic system (or hurricane) struck the islands of Hawai‘i and Maui in 1871.

Looking at the tracks of a few recent hurricane systems clearly illustrates the need for all islands to prepare. Figure 2-3 shows the roundabout path Hurricane Iniki took in 1992 that missed the islands of Hawai‘i, Maui, and O‘ahu, but struck Kaua‘i directly, destroying or damaging over 6,000 homes. If Iniki had turned north only six hours, earlier, O‘ahu, which has eight times more structures than Kaua‘i, could have been impacted. Figure 2-4 shows a satellite image of Hurricane Iniki with the outline of the Hawaiian Islands superimposed. The major damaging winds and rain associated with the spiral bands and eye are concentrated only over Kaua‘i. Typical wind damage is shown in Figure 2-5, and measures to prevent this are covered in Part 4. In addition to damaging winds and rain, the hurricane brings an elevation of coastal water called “storm surge” (see Figure 2-6). Storm surge maps have recently been put online for Hawai‘i (see Part 3.6).

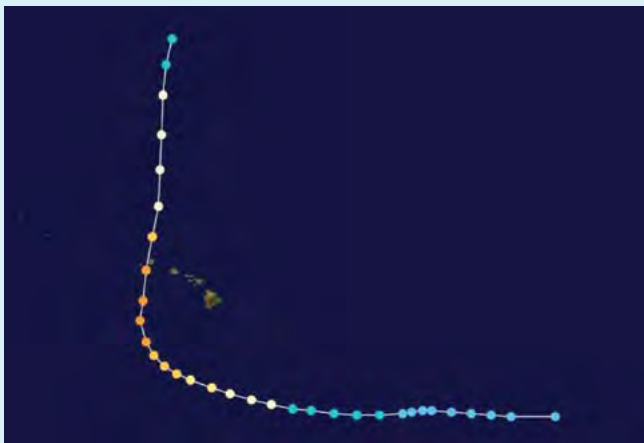
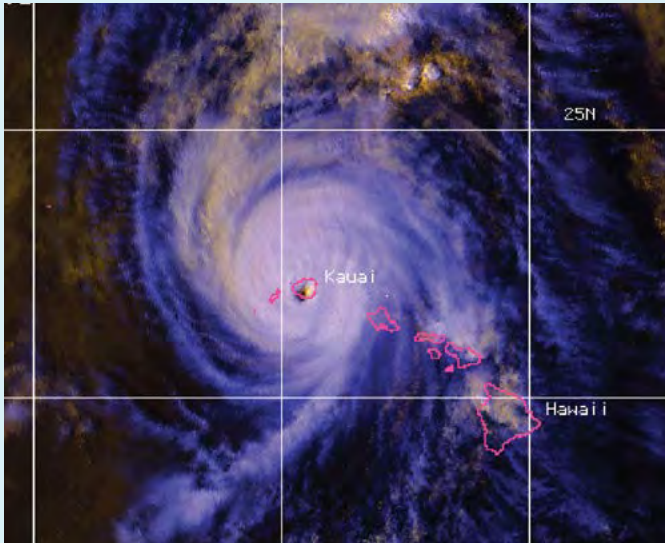

**Figure 2-3. Track of Hurricane Iniki in 1992 and its evolution from a tropical depression and tropical storm (blue and aqua colors) to a major Category 4 hurricane (orange). Iniki suddenly curved due to a low pressure system to the north. Note, hurricanes avoid high pressure and move toward low pressure. From NOAA National Weather Service, Honolulu.**

**Table 2-2. Expectations of Wind-Related Damage in Hawai‘i for Different Hurricane Categories (1 to 5)<sup>11</sup>**

No.	Wind mph	Damage
1	74–95	No real damage to sturdy buildings. Damage to poorly constructed older homes or those with corrugated metal. Some tree damage such as palm fronds torn from the crowns. Examples: ‘Iwa (Kaua‘i, 1982), Dot (Kaua‘i, 1959), Nina (Kaua‘i, O‘ahu, 1957).
2	96–110	Some damage to building roofs, doors, and windows. Considerable damage to poorly constructed or termite-infested homes. Trees blown down, especially those that are shallow rooted.
3	111–130	Some structural damage to well-built small residences. Extensive damage to termite-infested buildings. Large trees blown down. Up to 50 percent of palm fronds bent or blown off. Some large trees, such as monkey pod and breadfruit, blown down, especially if the ground is wet. Example: Iniki (Kaua‘i, 1992).
4	131–155	Extensive damage to non-concrete roofs. Complete failure of many roof structures, windows, and doors, especially unprotected, non-reinforced ones; many well-built wooden and metal structures severely damaged or destroyed. Considerable glass failures due to flying debris and explosive pressure forces created by extreme wind gusts. Complete disintegration of structures of lighter material. Up to 75 percent of palm fronds blown off. Many large trees blown down. Major erosion of beach area.
5	> 156	Total failure of non-concrete-reinforced roofs. Extensive or total destruction of non-concrete residences. Some structural damage to concrete buildings from debris such as cars or appliances. Many well-constructed storm shutters ripped off from structures. Many large trees blown down. Flooding and major damage to lower floors near the shoreline. Example: No record in Hawai‘i, Andrew (Florida, 1992).

From NOAA National Weather Service, Honolulu, after Lander and Guard. These guidelines are projections and should be treated as approximations of wind damage. Damage in some cases may result from lesser winds than indicated. Local topography (surface configuration of an area) may also strengthen or weaken the winds. Wind speed is based on the average speed of sustained winds over a one-minute period. See the cited reference for the complete guideline.



**Figure 2-4. NOAA satellite image of Hurricane Iniki, September 11, 1992. The band of strong winds and rain surrounding the eye of the hurricane missed the majority of Hawai'i's populated areas. Iniki passed west of these areas.**



**Figure 2-5. A common site on Kauai after Hurricane Iniki. Many roofs were blown off due to a lack of proper connection. Photo courtesy of Department of Commerce and Consumer Affairs Insurance Division.**

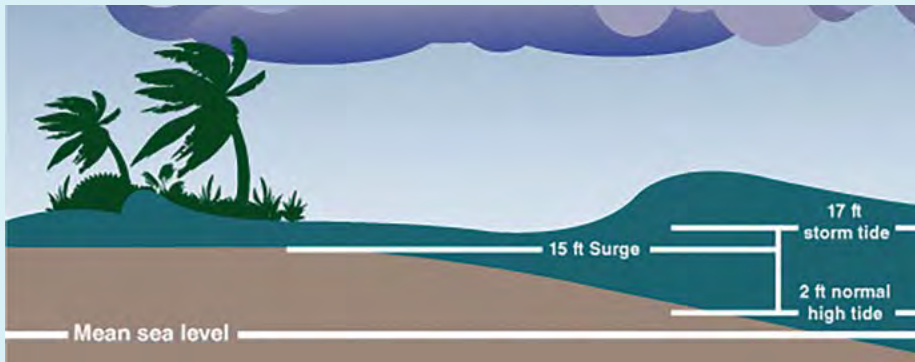

Figure 2-6. During a hurricane, there is an increased elevation of water levels caused by the low pressure of the hurricane and strong winds blowing onshore. The total water level is equal to the tides, plus the storm surge, plus the waves on top. Photo courtesy of NOAA.

The number of annual tropical cyclones varies over a multi-yearly period with El Niño and La Niña cycles (see Figure 2-7) and possibly over the long term with climate change, which can lead to warmer sea surface temperatures. Citizens must always be prepared since it only takes one cyclone to cause devastation, but the risk is greatest during El Niño years and may be growing over the long term.

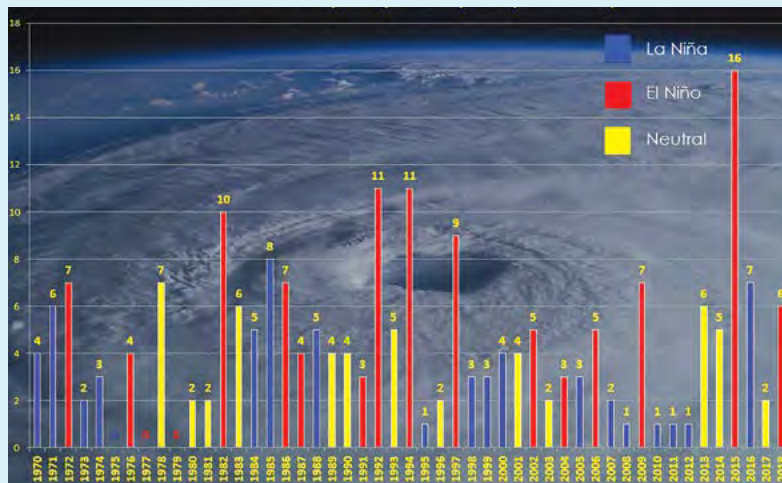

Figure 2-7. Number of Central Pacific tropical cyclones by year (1970-2018) with correlation to El Niño and La Niña Cycles. Figure courtesy of National Weather Service Forecast Office Honolulu. El Niño events, in red, are characterized by weaker trade winds allowing warm water to collect in the Eastern Pacific, the breeding ground for hurricanes. ‘Iwa in 1982, Iniki in 1992, and the record number of 16 events in 2015 occurred during El Niño years. 2015 was believed to be a Super El Niño, possibly linked to climate change. You can get the latest status by looking up El Niño Advisory at NOAA’s Climate Prediction Center.



Hawai‘i was very fortunate to escape major damage from all the activity in recent years (see Figure 2-8). Tropical cyclones surrounded the islands in 2015, 2016, and 2018. Hurricane Lane, in 2018, was particularly threatening (see Figure 2-9). Fortunately, a devastating hit was avoided. Citizens could wrongly surmise that hurricane risk, and the need to prepare is low.

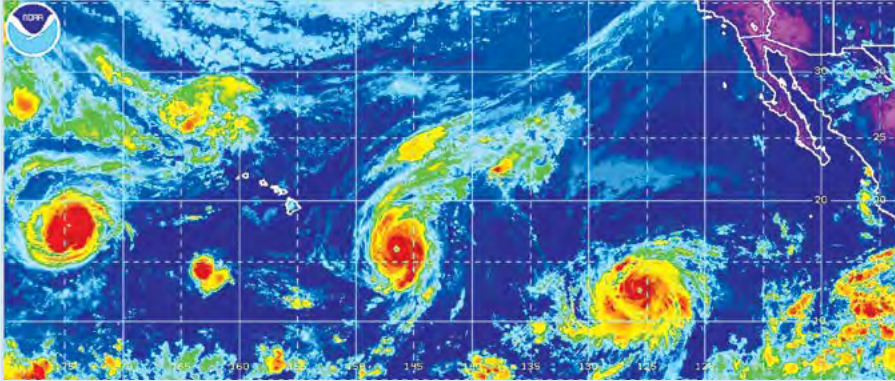

Figure 2-8. The 2015 hurricane season brought a record number of 16 tropical cyclones, and for the first time, 3 simultaneous major hurricanes (Category 3 or higher) in the Central Pacific. In 2016, Lester and Madeleine bracketed the islands. In 2018, there was the potentially devastating impacts from Lane and Olivia.

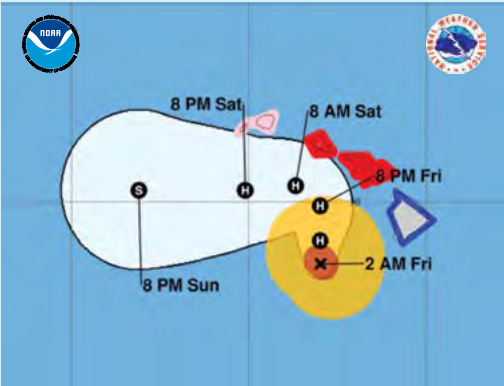
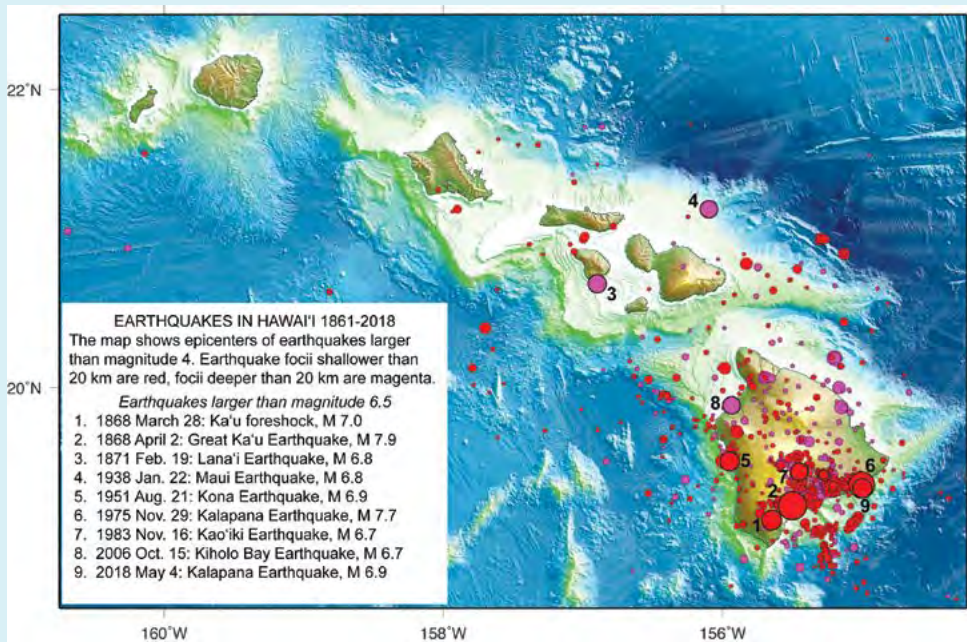

Figure 2-9. Lane was a major category 3 hurricane less than 2 days from O‘ahu. Wind shear at high altitudes decoupled the hurricane from its base and low elevation trade winds pushed the system west. The white cone of uncertainty represents a 67% probability that the center of the system will be in the cone (33% probability the center will be outside). The diameter of the hurricane force winds (brown circle) extend outside the center, and the diameter of tropical storm force winds (yellow circle) extend even further. Thus, being outside the

cone does not guarantee safety. Citizens should constantly monitor local media and emergency management and civil defense agencies for instructions. A recent study by Pacific Disaster Center indicates a Category 2 hurricane could damage or destroy over 50,000 houses on O‘ahu (see Reference Link 1 to read more).

## 2.3 Earthquake Hazards in Hawai'i

All the islands are at nearly equal risk for hurricanes and tsunamis. For earthquakes, however, the risk does differ from one island to the next. The greatest concentration of earthquake activity is found near the island of Hawai'i, although there have been significant earthquake events near Maui (1938) and Lana'i (1871) (see Figure 2-10). These earthquakes, including the one off Hawai'i on October 15, 2006, are deeper earthquakes caused by bending of the Earth in response to the developing load of the island mass. However, more numerous are the shallower earthquakes resulting from the intrusion of magma around the active volcanoes and the buildup and then release of stress along ruptures and fault surfaces.<sup>12</sup>



**Figure 2-10. Distribution of earthquakes in the Hawaiian Islands from 1861 to 2018. The larger dots are associated with the larger earthquakes. The most frequent and larger events are associated with the southeast coast of the island of Hawai'i. The location of the October 15, 2006 earthquake is marked with dot 8. The magnitude 6.9 earthquake of May 2018 associated with volcanic eruptions is dot 9. Courtesy of USGS and Gerard Fryer – Hawai'i Institute of Geophysics and Planetology, University of Hawai'i.**

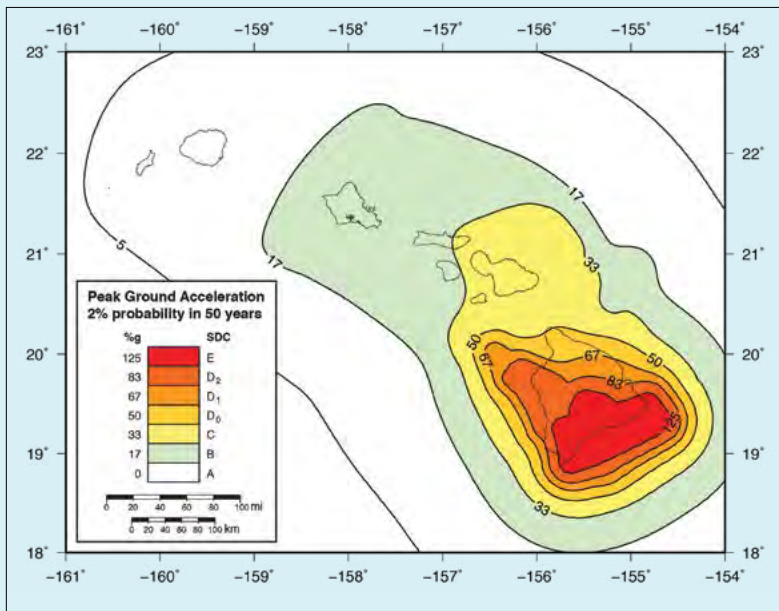

**Figure 2-11.** Scientists have developed maps that relate the probability of earthquake strength for different areas based on the distribution of earthquakes in a given region. This map indicates that the strongest earthquake shaking will occur along the southeast portion of Hawai‘i County while the weakest will be felt near Kaua‘i. The southeast part of the Island of Hawai‘i has the highest expected ground acceleration (125 percent of gravity) that has a 2% chance of occurrence during a 50-year time period. From U.S. Department of the Interior—U.S. Geological Survey.

Figures 2-10 and 2-11 indicate that homeowners in Hawai‘i County should be the most concerned about earthquakes, earthquake insurance, and strengthening their homes for ground motion, much less so for Kaua‘i homeowners who would be the least impacted by this type of hazard.

Also based on these figures, the most likely source for a local tsunami generated by a local earthquake is from Hawai‘i. (Remember that for a distant tsunami, all islands are at equal risk). Because residents of the island of Hawai‘i are likely to be closest to the source when there is a local earthquake, they will have the least amount of warning time, if any. Thus, it is especially important for those residents to know that if they feel shaking strong enough that they lose their balance and cannot stand, they should move to higher ground outside of the evacuation zone as quickly as possible. Residents should also be aware of nature’s own warning signals to

evacuate (see Part 3). It will be relatively rare or unlikely that shaking will be so strong that those on O‘ahu or Kaua‘i might have trouble standing.

## 2.4 Flood Hazards in Hawai‘i

Flooding is probably the most common, if not the most intense, natural hazard in the state. Flooding can be caused by a hurricane, tropical storm, tropical depression, or any other weather system that produces heavy rain. Flooding can build up gradually over a period of days, or suddenly in a few minutes (commonly known as a flash flood). In addition, coastal flooding and wave inundation can be produced by a tsunami, hurricane, or high-surf event with waves generated by local storms or even storms thousands of miles from Hawai‘i. Flooding can be associated with living near a body of water such as an ocean, stream, river, or reservoir.

In April 2018 record setting rain due to an upper level low pressure system over the state resulted in significant flash flooding, landslides, sinkholes, and erosion on Kaua‘i and O‘ahu. The rain gauge at Waipā Garden (Waipā Foundation) on Kaua‘i recorded a record-setting 49.69 inches of rain during a 24-hour period on April 15, 2018. Flooding occurred from Hā‘ena to Kōloa on Kaua‘i and Waimānalo to East Honolulu on O‘ahu. On Kaua‘i, homes and farmlands were flooded and inundated with knee-deep mud, and landslides blocked and damaged the only access road on the North Shore of Kaua‘i, isolating the Hā‘ena-Wainiha communities for months. The flooding left behind tons of debris on the roads as well as inside homes and schools. Over 350 homes were damaged and an unknown number of businesses were impacted.

To determine what locations are considered high-risk flood areas, look at the Federal Emergency Management Agency’s (FEMA) Flood Insurance Rate Maps (FIRM). These maps show what areas are susceptible to flooding and high velocity wave action (for those near coastal areas) from a one percent annual chance event (a.k.a. 100-year flood). The State of Hawai‘i Department of Land and Natural Resources (DLNR) maintains a map viewer tool that displays the current effective Digital Flood Insurance Rate Maps (DFIRM) for Hawai‘i (see Figure 2-12).



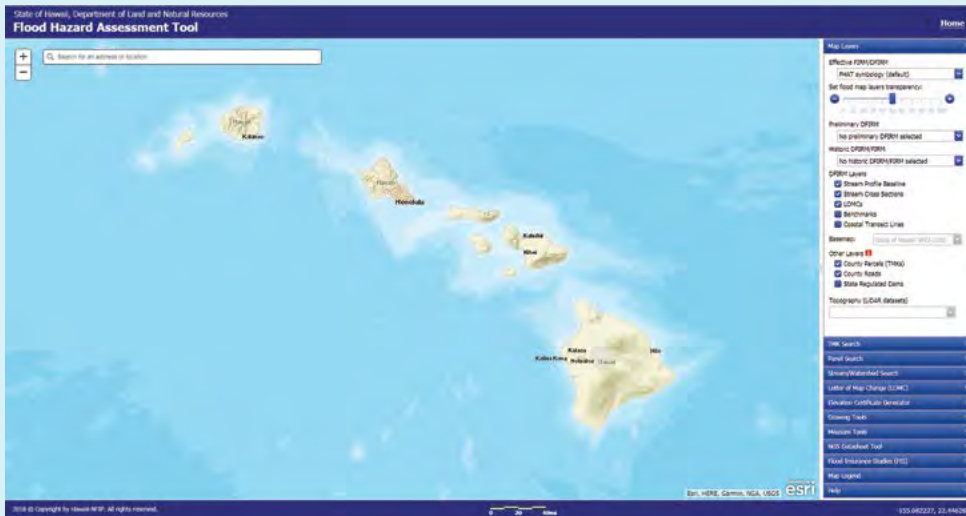
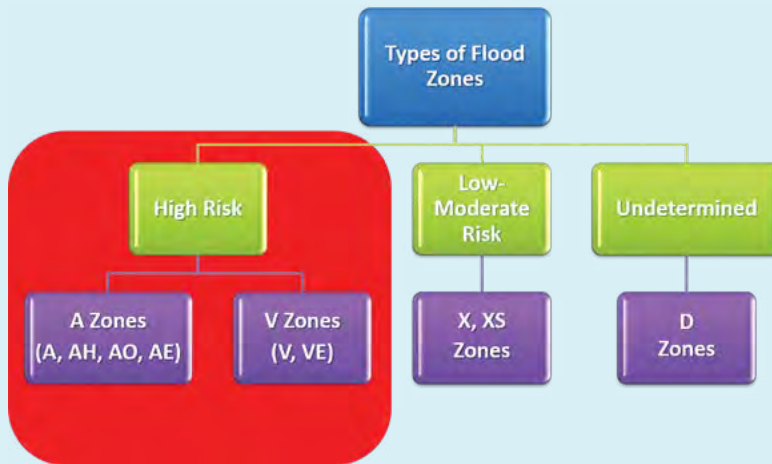

**Figure 2-12. The Hawai'i Flood Hazard Assessment Tool (<http://gis.hawaiiinfip.org/fhat>) allows users to search for specific properties by site address or Tax Map Key (TMK) and determine their flood zone. A report can be generated for each property which indicates the level of flood risk as explained in Figure 2-13. The report will also indicate if the property is in a tsunami evacuation zone or dam evacuation zone.**

Flood Zones are geographic areas that FEMA has defined according to varying levels of flood risk. These zones are depicted on a community's FIRM and each zone reflects the severity or type of flooding in the area. Generally, these zones can be identified as one of three risk classifications (see Figure 2-13).

Even a property not in a high-risk flood zone may be at risk from flooding. According to FEMA, nearly 25 percent of flood insurance claims come from low-to-moderate risk areas.

A good way to determine the risk of flooding for your house is to observe and study your property. Even inland properties may be susceptible to flooding if there is poor localized drainage. If flooding occurs during small rain events, then the problem will be greater during a storm or hurricane. Improving local drainage will provide greater protection to the property, making the house more resistant to floods. In addition, flood insurance can also be purchased even for properties not in high-risk flood zones.



**Figure 2-13. High Risk Flood Zones are in the Special Flood Hazard Area (subject to inundation by the one percent annual chance flood or 100-year flood). They consist of flooding (A zones) and high velocity wave action (V zones) near the coast. In addition, there are areas of Low-Moderate risk (X zones) and areas where the risk is undetermined (D zones). While flood insurance is not required in X or D zones, the homeowner should consider flood insurance if there are localized flooding or drainage conditions on their property as indicated by past weather or storm events.**

## 2.5 Volcano Hazards in Hawai‘i

Hawai‘i is home to a number of active and potentially active volcanoes. Frequent and at times long-lasting eruptions can impact people and communities across the Hawaiian Islands. This is especially true for residents on the Island of Hawai‘i, which consists of five volcanoes, four of which are classified as active: Kīlauea, Mauna Loa, Hualālai, and Mauna Kea. Two other active volcanoes in the state include Lō‘ihi, a submarine volcano about 0.4 mi below the ocean surface southeast of the Island of Hawai‘i, and Haleakalā on the Island of Maui. Homeowners should know where they live with respect to lava flow hazard zones and potential sources of volcanic gas which can affect the entire state.

Large amounts of volcanic gas (see Reference Link 2 and 3), primarily water vapor ( $H_2O$ ), carbon dioxide ( $CO_2$ ), and sulfur dioxide ( $SO_2$ ), are released during volcanic eruptions such as the recent eruptions at Kīlauea Volcano (see Figure 2-14). As  $SO_2$  is released, it reacts in the atmosphere with oxygen, sunlight, moisture, and other gases and particles, and within

hours to days, converts to fine particles called aerosols. The particles scatter sunlight and cause the visible haze that is observed downwind of the eruption site, known as vog (volcanic smog). Vog can pose health hazards to residents and visitors, damage agricultural crops and other plants, affect livestock operations, and impact visibility. Homeowners can minimize impacts of vog by reducing exposure (stay inside or leave impacted area), staying hydrated, not smoking, and using over-the-counter nasal sprays and eye drops. Medical assistance should be sought, if needed. (Note: information about vog hazards, health impacts, and how homeowners can reduce the impacts of vog can be found on the interagency vog dashboard. See Reference Link 3).

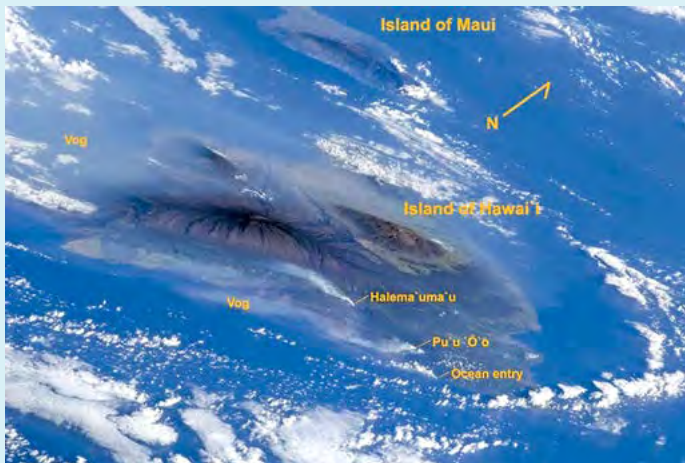

**Figure 2-14.** In this 2018 photo, volcanic gas can be seen spewing from Halema'uma'u Crater, located within the larger summit crater of Kilauea, and Pu'u 'O'o Crater, along the east rift zone of Mauna Loa. These gases become VOG and can impact the entire island chain during Kona wind conditions. Photo courtesy of NASA.

The greatest threat from volcanoes are lava flows, which typically erupt from the volcano's summit or along rift zones on its flanks. On the Island of Hawai'i, about 40% of Mauna Loa and 90% of Kilauea have been covered by lava erupted in the past 1,000 years and 14% of the combined area of Hualālai, Mauna Loa, and Kilauea have been covered since 1800. U.S. Geological Survey (USGS) scientists have identified lava flow hazard zones using the record of past lava flows combined with detailed topographic maps (see Reference Link 4, 5, and Figure 2-15).

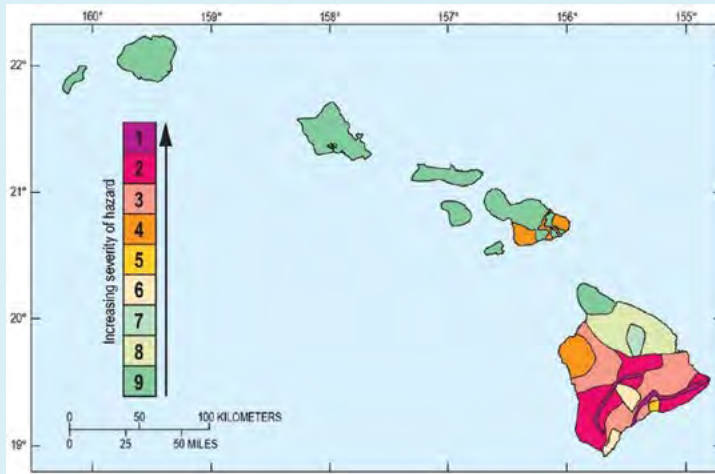
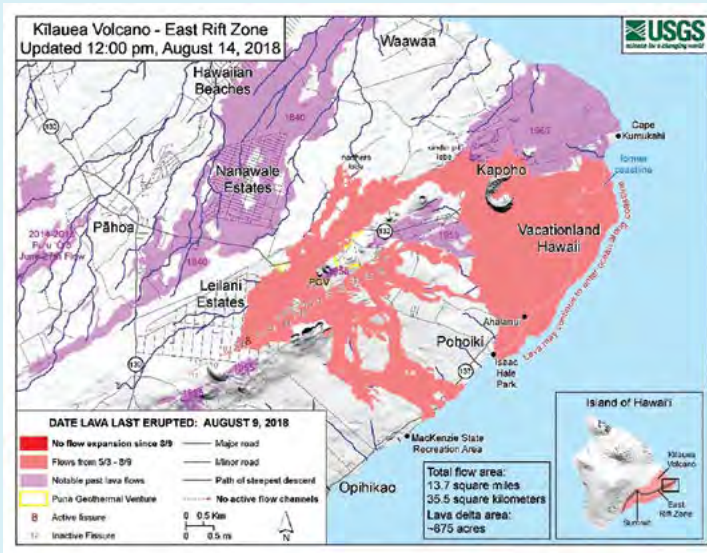

**Figure 2-15. Lava Flow Hazard Zone Map for the State of Hawai‘i. Homeowners on the Islands of Hawai‘i and Maui should be aware of where they are located with respect to lava flow hazard zones. On May 3, 2018, lava flow activity began in the Lower East Rift Zone on the southeast part of Hawai‘i and lasted for 3 months (See Figure 2-16).**

Beginning in May of 2018, the active lava flow broke through the surface in Leilani Estates subdivision in lower Puna on Hawai‘i Island (see Figure 2-16). With only a few days of warning, many residents were forced to evacuate rapidly and remove critical belongings to avoid advancing lava flows, spatter, voluminous clouds of volcanic gas, and widening ground cracks (see Figure 2-17). Meanwhile at the Kīlauea summit, ongoing summit subsidence in response to magma withdrawal produced a series of 64 collapse events of the caldera floor, gas and ash emissions, and dramatic changes in the size and depth of Halema‘uma‘u Crater (see Reference Link 6).

In addition to lava, infrequent explosive eruptions can occur. Explosive eruptions (see Reference Link 7) have occurred at Kīlauea and Mauna Loa Volcanoes (see Reference Link 8) during the past 2,500 years and additional explosive eruptions are likely in the future. A change in the current, slow lava flow period at Kīlauea to more explosive behavior will present significant new risks, including pyroclastic surges (see Reference Link 9) as well as rock fragments and ash falling over broad areas of the Island of Hawai‘i. Evacuation procedures for volcanic hazards are covered in Part 3 under Emergency Planning.





**Figure 2-16.** This map of the Lower East Rift Zone shows the 1840, 1955, 1960 and 2014-2015 flow events in purple, as well as the 2018 flow (red) which surpassed all similar events in recent history. The new lava delta extended almost one mile past the former Kapoho Bay shoreline (marked by the pale dashed line) at the Vacationland Hawai'i area.



**Figure 2-17.** Lava reaches Kapoho Bay. Lava (hot molten or semifluid rock) travels downslope and buries or burns everything in its path. The 2018 lava flow destroyed about 720 homes. When lava enters the ocean, “laze” is created, a corrosive seawater plume laden with hydrochloric acid and fine volcanic particles that can irritate the skin, eyes, and lungs.

## 2.6 Climate Change in Hawai'i

Climate change is associated with the warming of the Earth's atmosphere and oceans through the buildup of greenhouse gases. Atmospheric concentration of carbon dioxide, a key greenhouse gas, has increased by about 40% since the industrial revolution and is higher than any levels measured in ice cores that date back 800,000 years, and, based on other data, perhaps higher than any time in the past 4.6 million years.

There are many hazards which are indirectly or directly related to climate change. The most important ones that are now covered in this section include drought, wildfire, extreme heat, infectious disease, sea-level rise, and erosion. Before proceeding, it should be noted that there is more on climate change than can be adequately covered in this book. Also, while homeowners should prepare for climate change impacts, they should also work to reduce carbon emissions by adopting a resilient, adaptive, and sustainable lifestyle (see Reference Link 10 and 74).

### 2.6.1 Drought

Drought conditions are associated with prolonged periods of abnormally low rainfall. This can lead to damage to crops and livestock, severe economic damage, dustbowl, erosion of the landscape, damage to terrestrial and aquatic wildlife habitats, and enhanced wildfires. (For more information on the drought hazard see Reference Link 11). Individuals can look up the current conditions of drought in their area by going to the Drought Monitor for Hawai'i (see Figure 2-18 and <http://dlnr.hawaii.gov/drought>).

Climate change is expected to increase the drought risk. In Hawai'i, there has been an overall decline in rainfall in the last 30 years and a decrease in stream base flow over the last 70 years. Hawai'i has experienced longer droughts with more consecutive dry days and fewer days of intense rainfall (see Reference Link 10 and 12).

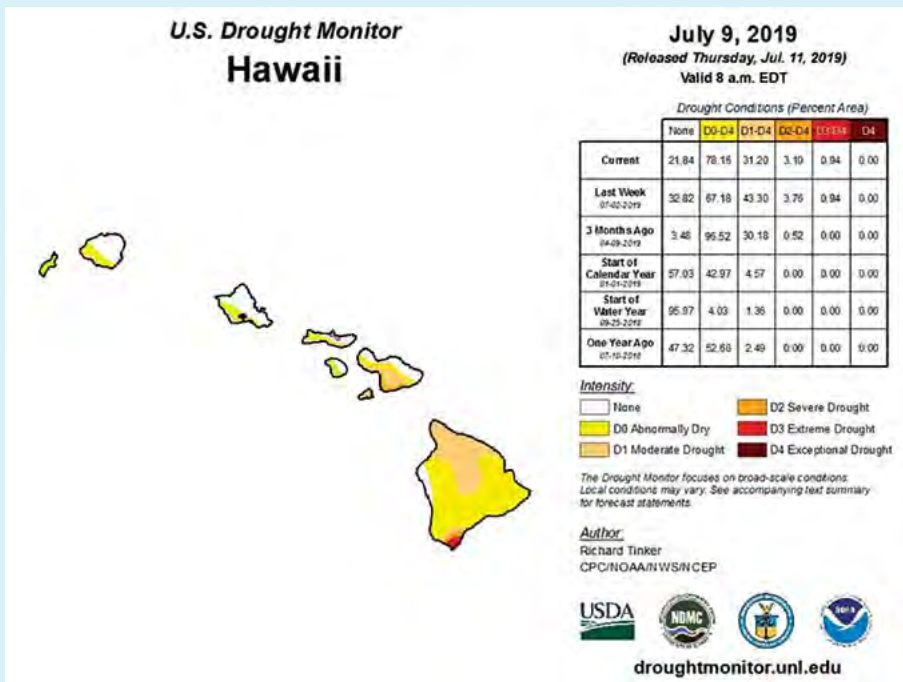

Figure 2-18. The Drought Monitor for Hawai‘i is part of the Drought Monitor for the U.S. and is updated weekly. Drought conditions range from None to Exceptional Drought. D0 can be considered a drought watch with areas going into or coming out of a drought. D1 to D4 are four levels of increasing drought conditions. According to this map, on July 9, 2019, 78.16% of Hawai‘i was in an abnormally dry condition or worse.

## 2.6.2 Wildfire

Wildfires are a frequent and significant hazard across Hawai‘i. They threaten lives, homes, safety and health, as well as impacting island resources like forests, drinking water, and ocean environment. In 2018, wildfires destroyed 21 houses on Maui and burnt over 9,000 acres on O‘ahu. All of the islands are subject to wildfire risk (see Figure 2-19). Note the abnormally dry conditions in Hawai‘i on July 9, 2019 (see Figure 2-18) and the subsequent wildfires on Maui from July 11-15, 2019, which burned a record 9,200 acres. According to Dr. Clay Trauernicht, Wildfire Extension Specialist with the University of Hawai‘i CTAHR Cooperative Extension and Pacific Fire Exchange, wildfire is tied to rainfall patterns much more than temperature. Fires are more frequent in dry leeward areas, and larger fires happen under drought conditions.

Climate change is expected to significantly increase the drought risk, and thus the wildfire frequency, since the risk of wildfire is tied to drought conditions. Therefore, it is expected there will be more wildfires like those seen in Hawai‘i and California in 2018 (see Reference Link 13).

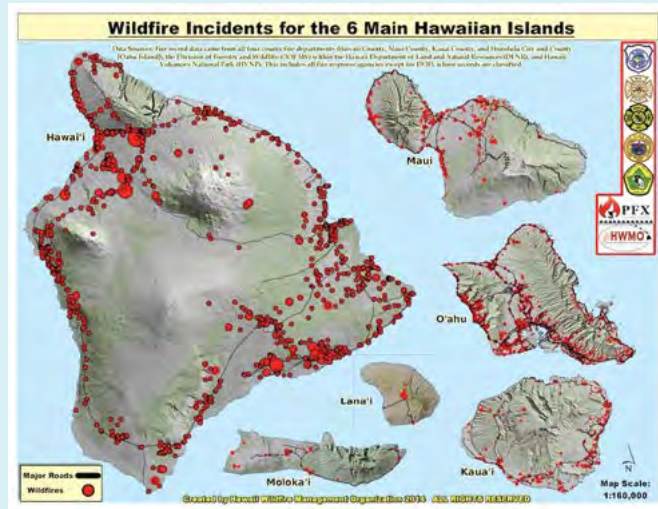

Figure 2-19. Data put together by the Hawai‘i Wildfire Management Organization contains over 13,500 fire records. This 2014 map is currently being updated. Note the high frequency of roadside ignitions along the wildland-urban interface, indicating the major role of humans in starting fires. Also note the high frequency of wildfires in leeward areas. Yet wildfires can occur anywhere (see Reference Link 14 and Figure 2-20).



Figure 2-20. For an interactive map of the history of wildfire across the state, go to the College of Tropical Agriculture and Human Resources (CTAHR) website (<http://gis.ctahr.hawaii.edu>). Zoom in to see the number of wildfire events in the area of interest, as well as the size of the wildfire in acres impacted. Note that this figure includes the approximate location of the 9,200 acres on Maui burned on July 11-15, 2019 (indicated by the red star).

### 2.6.3 Extreme Heat

Average global atmospheric temperature has increased by about 1°C (1.8°F) over the past century, closely following increases in carbon dioxide and other greenhouse gases. Temperatures in Hawai‘i have been on the rise, as indicated from data stations from 1919 to 2006 that show a gradual increase with a rapid acceleration from 1975 to 2006 of 0.3° F per decade. By 2085, using high emission scenarios, there is a projected increase of 4-5° F for Hawai‘i, if greenhouse gases are not curtailed (see Reference Link 15).

With increased temperatures, residents could face increased vulnerability to extreme heat and associated illnesses such as heatstroke and cardiovascular and kidney disease. Especially vulnerable people are those under 5 years old or those 65 years and older, living in poverty (see Reference Link 16). Sensitivity is especially high after power outages, when there is no electricity to cool residences or run medical equipment. Such contingencies should be planned for (emergency generators, natural cooling ventilation, backup systems with redundancy, heat reflecting roofs and windows).

### 2.6.4 Infectious Disease

Climate is an important driver of the current distribution and incidence of many infectious diseases, such as dengue fever. Globally, the incidence of dengue fever has increased 30-fold over the past 50 years. The reader is referred to the Hawai‘i State Department of Health website for information about especially relevant, mosquito-transmitted diseases such as Dengue, West Nile Virus, and Zika, as well as diseases transmitted by other methods, such as animal-, food-, or blood-borne diseases (see Reference Link 17). The key to preventing mosquito-borne infections is to: (i) use Environmental Protection Agency (EPA) approved mosquito repellent, (ii) wear long pants and long-sleeved shirts outdoors, (iii) maintain screens on windows and doors, (iv) empty or drain standing water, and (v) remove objects that can hold water (see Reference Link 18).



## 2.6.5 Sea-level Rise

Associated with the warmer Earth is the rise of sea level caused by the thermal expansion of warmer ocean water and the melting of glaciers and ice sheets. The most up-to-date scientific literature points to 3 feet of sea-level rise (SLR) as an intermediate scenario and 8+ feet of SLR as a worst-case scenario in this century (see Figure 2-21). Further, sea-level rise is projected to be higher than global averages around tropical regions, including Hawai‘i.

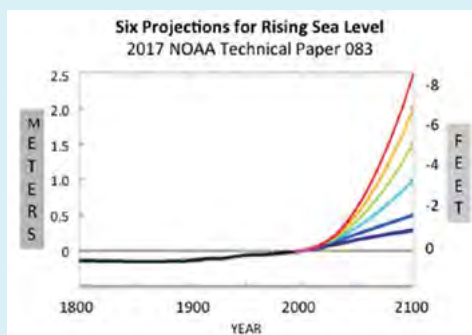

**Figure 2-21. Projections of global sea-level rise, ranging from 3 feet as an intermediate scenario to 8 or more feet as a worst case scenario, this century. Adapted from figure found on <https://www.researchgate.net>; see Reference Link 19.**

Homeowners can use the Hawai‘i Sea Level Rise Viewer to look at projections of future sea-level rise (see Figure 2-22, Reference Link 20).



**Figure 2-22. A screen grab from the Hawai‘i Sea Level Rise Viewer showing the 3.2 foot Sea Level Rise Exposure Area (blue shading) for the Kapa‘a region of Kaua‘i. The Viewer depicts coastal hazard exposure areas with sea-level rise including passive flooding (still water high tide flooding) and, if available, annual high wave flooding (over-wash during the largest wave events of the year) and coastal erosion.**

Sea-level rise will increase the frequency and severity of natural hazards' impacts on our coasts from waves, high tides, coastal erosion, storm surge, tsunamis, and flooding. Hawai'i is especially vulnerable with approximately 750 miles of coastline and extensive development in low-lying areas. Homeowners should look at the numerous ways to protect themselves from future impacts by purchasing insurance, by building stronger, or by retrofitting, if possible (Part 4).

The Sea Level Rise Vulnerability and Adaptation Report, approved by the Hawai'i Climate and Adaptation Commission in December 2017, provides the first statewide assessment of Hawai'i's exposure and vulnerability to sea-level rise, including recommendations to reduce exposure and increase capacity to adapt (see Reference Link 21). With 3.2 feet of sea-level rise as early as the middle of this century, it is estimated that over 6,500 structures located near the shoreline would be compromised or lost, leading to over 20,000 displaced residents in need of new homes.

## 2.6.6 Beach Erosion

Beaches in Hawai'i are highly variable and dynamic environments with waves, currents, and winds constantly shifting sands and reshaping the shoreline (see Figure 2-23). Large seasonal swells and storm waves can erode most or all of a beach in a matter of hours, with the beach fully or partially recovering after waves subside. Erosion trends are also highly variable from one section of beach to the next depending on wave energy, sediment transport and supply, and in many locations, man-made interference in beach processes. The majority, or 70%, of beaches in Hawai'i are undergoing long-term or "chronic" erosion (see data from the University of Hawai'i Coastal Geology Group, Reference Link 22). Chronic erosion trends are typically punctuated by erosion events during high waves and storms, from which the beach may never fully recover.





**Figure 2-23. Homes on the north shore of O‘ahu in 2013 were threatened by seasonal waves and erosion. Photo courtesy of Dolan Eversole. Many communities are already experiencing impacts from coastal erosion, wave run-up, or flooding, and sea-level rise will exacerbate the problem.**

Adapting to sea-level rise will make communities more resilient to both current and future natural hazards, a “no-regrets” approach to adaptation. To this end, it is important to be aware of and consider the potential exposure to all natural hazards as a baseline, along with future scenarios that include additional climate change and sea-level rise exposure. Homeowners should consider adaptive measures when siting, designing, building, or retrofitting habitable structures and supporting infrastructure (such as sewage disposal systems).



# Part 3

## Protecting Yourself and Your Family

This part of the handbook covers the topic of protecting yourself and your family from natural hazards. In particular, it is important to stock emergency supplies, an evacuation kit, and have an evacuation plan for key hazards (hurricane, tsunami, wildfire, earthquake, and flood) since they each pose a different kind of threat. Discuss the evacuation plan with family members and practice it once a year, or whenever there is a major change (for example, when a member of the family goes to a new school or is working in a different location).

### 3.1 Emergency Supplies

A stock of emergency supplies will be helpful during a major event like a hurricane or tropical storm, as well as for a minor event like a simple power outage. The importance of these supplies was demonstrated during the October 15, 2006, earthquake, which knocked out power throughout much of the state. The goal in being prepared is not having to go to the store for food or water when an emergency watch or warning is called. Gather emergency supplies as soon as possible and check them at least twice a year to ensure that they are complete, unused, and fresh (clearly mark expiration dates with an indelible ink marker and check expiration dates). Old food and water should be used or discarded and replaced with fresh supplies. Do not keep expired supplies. Supplies should include at least the following:

- Portable radio, flashlight, and extra batteries.** Flashlights with light emitting diodes or LEDs can last many times longer on the same set of batteries versus those with conventional incandescent bulbs.
- At least a fourteen day supply of water.** A reasonable estimate is one gallon per person per day for drinking, cooking, and personal hygiene needs (“potable water”). It is important to have available good water containers for any water-interruption situations. Four-



to six-gallon water containers are readily available in stores. “WaterBOB” or “AquaPod” plastic bladders are useful in an emergency, unfold and lay in a bath tub and can store up to 100 gallons of potable water. Waterfull makes an emergency water storage barrel that replenishes potable water with use (see: <https://www.waterfull.com>). Water for non-potable use can also be stored in unlined bathtubs, rubbish containers, or washing machines.

- At least a fourteen day supply of nonperishable foods.** Limit purchases to items used during normal conditions, or they are likely to just expire. Buy supplies with a long-shelf life (e.g., 3 to 4 years to up to 30 years for certain freeze dried emergency foods). Mark expiration dates with a Sharpie and put items that need to be used first at the top of the supply pile. Begin to use one year before expiration and replace with fresh supplies (see Reference Link 23).
- Hibachi with charcoal, camping stove with fuel, or barbecue grill with propane.** Do not use these items indoors or in an area with no ventilation. Follow all manufacturer instructions.
- Manual can opener**
- Matches or lighter**
- Disposable plates and kitchen utensils**
- First-aid kit**
- List and supply of special medications** (prescriptions and others)
- Whistle to call for help**
- Pet food, extra water, and supplies for your household pets**
- Specific supplies for infants or the elderly**
- Portable toilet or porta potty**

**Backup power for mobility or life-supporting devices**  
(generators or preferably solar powered)

**Spare cash** (ATM machines may not have power)

Optional additional items:

**Waterproof plastic sheeting or blue tarp, with string or rope**

**Cleaning supplies and rubber boots**

**Cell phone and a hard-wired, single line phone.** Cell phone networks may be overloaded during times of natural hazards. Cordless phones with a base station will not work without electricity. If you need to rely on cordless phones, get an alternate source of power. Otherwise, have an old-fashioned corded phone. Use the phone only in an emergency during a natural hazard.

**Alternate power supplies.** During an emergency or power outage, you may need to rely on alternative sources of power (e.g., generators, inverters, power stations, and battery chargers). Solar powered alternatives would not rely on gas which could be difficult to obtain.

Gather supplies over a period of time rather than rushing out during an emergency when shortages are likely. Do not return emergency supplies after a watch or warning as it places a burden on the vendor and community. Keep the items as part of a long-term emergency supply stock. This will prevent you from getting “hurricane fatigue” by not having to repeatedly buy and return emergency items. If you plan to shelter in your home, be sure that it is outside any flood or storm surge zone and is a strong dwelling (see Parts 3 and 4).

## 3.2 Evacuation Kit

An evacuation kit differs from a stock of emergency supplies at home since the kit is what you will take if you need to leave your house in an emergency. An evacuation kit should be prepared as soon as possible and can be checked before the beginning of hurricane season, which runs June 1 to November 30. The components of the kit should be stored in one place, perhaps in a duffle bag or backpack, or on wheels, so that it is ready to go at a moment's notice. The kit is primarily for evacuation during a hurricane, although it could be used for other situations (including tsunami evacuation, dam failure evacuation, lava flow, wildfire, police situation, etc.).

The following evacuation kit list was compiled with the input of county civil defense and emergency management agencies:<sup>13</sup>

- Half gallon of potable water per person per day**  
(for drinking only) for fourteen days (or as much as you can)

Personal items—carry-on bag with:

- Family needs, such as supply of daily prescription medications, nonperishable food and any special dietary foods, can opener, infant formula, and diapers**
- Prescription eyewear and personal hygiene items such as waterless cleaner, toothbrush/toothpaste, toilet paper**
- List of any required medications, special medical information, medical care directives, health insurance card, personal identification, and other important documents**
- First-aid kit**
- Flashlights, portable radio, spare batteries**
- Change of clothes, towels**
- Pillows, blankets, and folding mattresses/air mattresses**

The American Red Cross recommends that the evacuation kit contain supplies for fourteen days. If the supply chain to Hawai‘i is disrupted (e.g., damage to airports, warehouses, or harbors), you will be better off than others who do not have adequate supplies. After Hurricane Iniki, people were not able to move out of the shelters and back into their homes for two weeks, as their roofs had to be temporarily fitted with plastic sheets or tarps.

### 3.3 Evacuation Planning

In Hawai‘i, it is important for families to plan for both a tsunami and a hurricane. They are different. In a hurricane, it is important to protect against strong winds, torrential rain, inland flooding, and coastal inundation (storm surge and waves). In a tsunami, the main hazard is coastal inundation.

Here are some general things to consider while developing an evacuation plan:

- Create the evacuation plan for a tsunami and hurricane and review it with your family every year.
- The evacuation plan should consider all family members, those with special health needs for whom you take responsibility (like the disabled or elderly), and your pets. Practice evacuation procedures with all family members through yearly drills.
- In an evacuation or emergency situation, all able-bodied persons (men, women, and children) should be able to take care of themselves if they act calmly and with proper direction. This is why it is important to practice the plan with the entire family regularly.
- Parents should confirm with their child’s school the evacuation plans that are in place, specifically, where the students will be held and for how long during each type of natural hazard. You should not have to drive to school to pick up your children.
- Consider how family members will communicate if they become separated. Each family member should have a list of telephone and



cellular phone numbers of everyone in the family and phone numbers of a few contacts outside of the family. A designated contact person out of state can help reconnect family members as it may be easier to call long distance than locally.

- Develop a plan for any household pets. Check in advance if there is a designated area or room in a hurricane shelter that can accept pets. Pets entering a shelter should be caged and the owners need to provide water and food for their pets (see the Hawaiian Humane Society’s website for details, <https://www.hawaiianhumane.org>, Reference Link 24). For a tsunami, take all pets along. Evacuation shelter restrictions will be irrelevant since evacuation will be to high ground outside the evacuation zone.
- If needed, develop a plan to help those who cannot help themselves, such as the disabled or those with limited mobility. If people with special health needs are with a care-provider, confirm that the care-provider has an evacuation plan. Otherwise, you, your family, your friends or relatives, or someone nearby who is designated can take responsibility for that person(s). Plan for people with special medical needs. A shelter may not have back-up power or the ability to maintain electricity. Most facilities will be partially compliant with the Americans with Disabilities Act of 1990 (ADA). Advanced medical care cannot be provided unless Disaster Medical Assistance Teams (DMAT) are pre-positioned in some locations. Special health needs evacuees must either be capable of taking care of themselves or be accompanied by a care-provider.
- Stay alert, calm, and be informed. Listen to local radio and television stations carefully as there may be new information or modified directions. Mother Nature is unpredictable and a team of scientists will always be monitoring unusual conditions for public safety.
- Know the difference between a tsunami watch and tsunami warning versus a hurricane watch and hurricane warning. Do not confuse the two. When each is triggered, there are different actions to take. Also note that the Pacific Tsunami Warning Center and/or the civil defense and emergency management agencies may issue what is called an Urgent Local Tsunami Warning in the case of a local earthquake and tsunami.

### 3.3.1 Key Definitions

**Urgent Local Tsunami Warning.** Issued when there has been a major earthquake in the Hawaiian Islands and a damaging tsunami is likely within minutes to tens of minutes. If the ground is shaking so severely that it is difficult to stand, take the shaking as a natural tsunami warning and move inland immediately; do not wait for the sirens to sound. If there is shaking, even if it is not very severe, and the sirens sound within a minute or two, immediately leave the coastal area, preferably on foot. Tune to local television or radio once out of the evacuation zone.

**Tsunami Warning.** Issued when a damaging tsunami is expected and people should evacuate from the tsunami zones (see Figures 3-1 and 3-2). When a warning is issued, sirens will sound and the warning will be broadcast by local media. Normally a warning is issued at least three hours before the tsunami arrives; the tsunami arrival time is part of the warning and will be repeated by the media. The warning continues until wave heights have dropped below hazard levels, which may be more than 12 hours. After a damaging tsunami, the warning will be downgraded to an advisory before it is cancelled.

**Extreme Tsunami Warning.** Issued when an extremely large earthquake occurs, triggering what is identified as an Extreme Tsunami (see Figures 3-1 and 3-2). When a warning is issued, sirens will sound and the warning will be broadcast by local media. In such an event, a warning may sound immediately allowing only three hours to evacuate from the tsunami zones before the tsunami arrives; the tsunami arrival time is part of the warning and will be repeated by the media. The warning continues until wave heights have dropped below hazard levels, which may be more than 12 hours. After a damaging tsunami, the warning will be downgraded to an advisory before it is cancelled.

**Tsunami Watch.** Issued if there is the potential for a damaging tsunami, but the existence of a tsunami has not yet been confirmed. A tsunami watch will always be upgraded to a tsunami warning or a tsunami advisory or will be canceled. If it is upgraded to a warning or advisory, that upgrade will occur with a target of at least three hours before the tsunami arrives. As soon as a tsunami watch has been issued, tune to local television or





radio for further information and prepare to evacuate in case the watch is upgraded to a warning.

**Tsunami Advisory.** Issued when a tsunami is expected, but will not be large enough to cause significant land flooding. Evacuation of the coast is not necessary, but the beach and coastal waters may be hazardous because of unusual waves and strong currents. Sirens will not sound, but beaches will be closed. The advisory will be continued until wave action falls below danger levels, which may take several hours.

**Hurricane Watch.** Issued when hurricane conditions (sustained winds of 74 mph or higher) are possible in the specified area of the watch, but the watch is called 48 hours before the possible arrival of the tropical storm winds (sustained winds of 39 to 73 mph). During a watch, prepare your home and review your plan for evacuation in case a hurricane warning is issued. As discussed earlier in this section, preliminary preparations should begin even before a watch has been issued.

**Hurricane Warning.** Issued when hurricane conditions (sustained winds of 74 mph or higher) are expected in the specified area of the warning, but the warning is called 36 hours before the expected arrival of the tropical storm winds (sustained winds of 39 to 73 mph). Complete hurricane preparations and leave the threatened area if directed by officials.

**Flash Flood or Flood Watch.** Issued when flash flooding or flooding is possible within the designated watch area. Be prepared to move to higher ground; listen to the NOAA weather radio station, local radio stations, or check your local television for information.

**Flash Flood or Flood Warning.** Issued when flash flooding or flooding has been reported or is imminent. Take necessary precautions at once. If advised to evacuate to higher ground, do so immediately.



### 3.3.2 Emergency Alert System

The Emergency Alert System (EAS) is the official source of natural hazard information and instruction in the state. This information can originate from county, state, or federal agencies. For example, the EAS network could disseminate warnings and/or instructions from the governor’s office during threats or emergencies affecting one or more counties within the state. The statewide network may also be activated by the National Weather Service Forecast Office to disseminate weather- or tsunami-related watches or warnings.

If a siren sounds, turn on a radio. Some radios with the NOAA weather radio band turn on automatically when an emergency broadcast through the EAS is announced. This could be useful for homeowners along the coast. The NOAA weather radio station broadcasts round-the-clock weather and surf conditions, and also participates in the EAS system.

All local radio stations have voluntarily agreed to participate in the EAS system. Additional information may also be available on local and cable television. There are also primary radio stations around Hawai‘i that have a wide circulation and specialized equipment including decoders and backup generators for use during emergency situations (see Table 3-1). These are the stations most likely to be in operation during the most difficult of times.

**Table 3-1. Primary Radio Stations Participating in the EAS Network\***

County	Local Primary	Phone Number
O‘ahu	KSSK-AM 590 khz	Office: 550-9200 / Request: 296-5959
O‘ahu	KRTR-FM 96.3 mhz	Office: 275-1000 / Request: 296-9696
Kaua‘i	KQNG-FM 93.5 mhz	Office: 245-9527 / Request: 246-9399
Maui	KMVI-AM 550 khz	Office: 877-5566 / Request: 877-1417
Maui	KAOI-AM 1110 khz	Request: 244-9145
Hawai‘i (Hilo)	KWXX-FM 94.7 mhz	Office: 935-5461 / Request: 296-5999
Hawai‘i (Hilo)	KBIG-FM 97.9 mhz	Office: 961-0651 / Request: 296-5244
Hawai‘i (Kona)	KWXX-FM 101.5 mhz	Office: 935-5461 / Request: 296-5999
Hawai‘i (Kona)	KBIG-FM 106.1 mhz	Office: 961-0651 / Request: 296-5244

\* All phone numbers are area code 808.



Some radio stations have been designated to transmit emergency messages in foreign languages. This includes KSSK AM 590 and FM 92.3; KZOO AM 1210 (**Japanese Language Station**); KREA AM 1540 (**Korean Language Station**) and KNDI AM 1270 (**Multi-Cultural Language Station to include: Ilocano, Tagalog, Hispanic, Cantonese, Mandarin, Laotian, Okinawan, Vietnamese, Samoan, Tongan, Marshallese, Chuukese, Pohnpeian, and English**).

Alerts and emergency messages may also come over smartphones. Visit the Federal Communications Commission Wireless Emergency Alerts (WEA) page to learn more about these alerts (Reference Link 25). To enable phone alerts, check the phone manual or with your wireless provider, as the exact process can vary between phones. (Note: Emergency alerts can often be found on your phone by browsing Settings).

All of the counties have emergency alert notification systems that are slightly different, and some may be delivered to smartphones, computers, home phones, or other devices. Learn how the system for the local county works by going to the following Reference Links:

Kaua‘i – Blackboard Connect 5 (Reference Link 26);

O‘ahu (City and County of Honolulu) – HNL.info App (Reference Link 27);

Maui – Maka‘ala (Reference Link 28);

Hawai‘i Island – Blackboard Connect (Reference Link 29).

Key emergency messages can also come from local emergency responders using public address broadcast systems (e.g., loudspeakers from police or fire). Always listen to county officials.

Finally, for proactive citizens, consider becoming an amateur radio operator (“HAM”). HAM radio has helped to provide key communications during many natural hazards in Hawai‘i (see Reference Link 30).

## 3.4 Evacuation Plan for a Tsunami

Plan for a tsunami event even if living inland, because family members may need to drive through or work in the evacuation zone. It is important to know whether to evacuate at home, work, school, or in your car, and where to evacuate to. Plan for tsunami evacuation before an event.

**The tsunami evacuation maps are found on the websites for the Civil Defense or Emergency Management Agency for all counties (Appendix A). The Hawai'i Emergency Management Agency also has the zones on their website (see Reference Link 31). For those without a computer, look at the most recent version of The Official Hawaiian Telecom Directory for each county (the 2018-2019 book is out and usually replaced in May). Always use the most recent phone book, as the evacuation maps may be updated at any time.**

The tsunami evacuation maps are a guide to determine the minimum safe distance to evacuate inland from a tsunami. **Note that for all islands except Hawai'i, there are now two evacuation zones.** (See Figures 3-1 and 3-2).

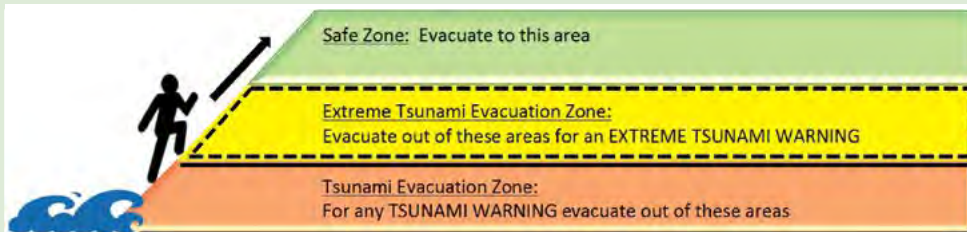

Figure 3-1. For Maui, O'ahu, and Kaua'i there are two evacuation zones. The first red zone is based off historical events that have impacted the state in the past. The larger yellow zone is based on computer modeling of a very rare extreme event generated by a magnitude (+9 earthquake). For Hawai'i County, the difference between the two zones was deemed insignificant and there is only one zone. When there is a Tsunami Watch, listen to TV and radio for instructions. For a Tsunami Warning, evacuate by walking or biking outside the red area. For an Extreme Tsunami Warning, evacuate to outside the red and yellow areas, into the green safe area.



**Figure 3-2. Example of the two zone evacuation using a map for Waikiki. If in Waikiki, use vertical evacuation (go to a concrete building greater than 10 stories tall, and go to the fourth floor or above). Outside of Waikiki, evacuate the red area for a Tsunami Warning, and the red and yellow area for an Extreme Tsunami Warning. All residents should know where the evacuation zones are relative to where they live, work, or go to school.**

For tsunami evacuation, listen to local radio. There are no official shelters that will be open before or during a tsunami. Generally, anywhere away from the coast and outside the evacuation zone(s) on high ground is suitable for tsunami evacuation. If in doubt, go farther inland to be safe. Later, if there is tsunami inundation or flood damage, some sites may be opened up as temporary shelters or refuges. Monitor official radio and TV broadcasts for shelters that may be open for a specific event. Shelters may eventually be set up for those whose homes are uninhabitable or inaccessible.

In general, stay off the roads. Only drive if it is absolutely essential. An evacuation plan for tsunamis should emphasize reaching an area by walking or biking. The police may close many roads during an emergency, so people can exit a freeway, but not necessarily get on it. On O‘ahu, buses will try to alter their normal routes and shuttle people to higher ground at no cost.

For a tsunami, the warning given will vary depending on the source of the generating event from 15 hours (Chile), 7.5 hours (Japan), or 4.5 hours (Alaska), to less than a few minutes for a local earthquake (See Table 2-1). An evacuation plan should consider each family member’s location, whether at home, school, work, or in the car, and the amount of warning time, which depends on the location of the generating event (see Table 3-2 for scenario planning). General statewide evacuation for a distant tsunami will begin three hours prior to estimated wave arrival.

Note the following when planning for tsunami evacuation:

- **Respect the power of a tsunami.** A ten-foot tsunami wave will inundate much further inland than a ten-foot wind-generated wave. From a distance, the tsunami wave may not look much more threatening than a normal wind wave, but it will just keep coming. The tsunami may inundate an area thousands of feet inland.
- A tsunami wave can wrap around the island. Thus, all coastal sectors may be at risk from the wave and not just the side that the tsunami is approaching from. For example, even though a tsunami may be generated by an earthquake near Alaska, north of the islands, residents on the south side of the islands can still be at risk because of wraparound.
- Tsunamis come in a series of waves, each of which may be 15 to 30 plus minutes apart. The largest wave is not always the first wave to arrive, but may be the second, third, or fourth. Do not believe that just because an area survived the first wave, it is safe from subsequent waves. Many people have drowned after making this assumption. There may be as many as ten or more waves in a tsunami train. Plan and prepare to be at your tsunami evacuation point for several hours. Do not leave until the all clear sign is given on TV or radio.
- **When a siren sounds, indicating an alert, listen to the local radio first for information and follow the instructions carefully.** It may be necessary to scan the radio band. The siren is the notice to tune to local media such as radio, but it does not necessarily signify a need to evacuate. Local television is also important but may contain information that is more applicable to one island than another, since broadcasts may be statewide.
- Local county civil defense or emergency management agency, through local radio and television, will give instructions about when to evacuate. When instructions are issued, move outside of the evacuation zone and to high ground immediately.

- 
- **Avoid driving unless it is essential.** Driving may contribute to potential gridlock that places other people and emergency responders in jeopardy. Remember that many roads will be blocked off. Plan to walk or bike to an evacuation area.
  - **If your house is outside the evacuation zone, stay there and stay off the road.** You will be more comfortable and will not add to traffic.
  - **If your house is inside the evacuation zone, then you must leave.** Households must evacuate even if the house is elevated on piers and columns and built according to standards for the National Flood Insurance Program.
  - **Do not drive to school to pick up children.** Most schools are outside the tsunami evacuation zone. Those very few public schools in the evacuation zone are required to have emergency plans and have carried out extensive drills to evacuate to higher ground. Trust the teachers to look after their students. The schools will keep children until the all-clear signal is given. This may take several hours. When it is safe, the school will contact parents or guardians to pick up their children. Coordinate with your school and children's teachers at the start of each year.
  - **In general, if you are at work and outside the evacuation zone, stay there.**
  - **On O'ahu and Maui only:** For concrete- and steel-reinforced buildings with ten stories or more, evacuation may be by vertical evacuation (i.e., moving to the building's fourth floor or above). This guidance may change, so listen to civil defense and emergency management officials for any vertical evacuation situation. For all other islands, vertical evacuation is a last resort. Moving to high ground outside the evacuation zone is safer than moving to high ground within the evacuation zone.

- **For Hawai‘i and Kaua‘i Counties: Vertical evacuation is not recommended. It may be a last resort for a local tsunami in the case when there is little time, but it is better to move inland to high ground.**
- **Return home only when the all-clear signal has been given.** Be prepared to wait several hours. It may take a distant tsunami 4 to 15 hours to reach Hawai‘i and 6 to 8 hours more for the train of waves to pass the state.

Table 3-2 summarizes many of these evacuation scenarios. General guidelines are provided for all locations, home, work, school, or car, for a tsunami from Chile, Alaska, or generated locally. The scenario for a Japanese tsunami would fall between those for a Chilean or an Alaskan event. Always follow TV and radio for specific instructions from local emergency management or civil defense agency.

**For a locally generated tsunami, there may not be enough time to receive a warning by siren and television or radio to evacuate. Therefore, utilize Nature’s Own Warning (“NOW”) evacuation signals based on unusual characteristics of the earthquake, surrounding sounds, and observations. For example, if you feel an earthquake so strong that you have difficulty standing, evacuate immediately. See the rest of the NOW signals in Table 3-3.**

**Table 3-2. Tsunami Evacuation Scenario - General Guidelines**

Source & Time	If you are at home	If you are at work	If you are at school	If you are in your car
<p><b>Local Tsunami Arrival in less than 5 minutes to 40 minutes</b></p>	<p>If inside the evacuation zone, walk out to evacuate if: (i) siren and instructions to evacuate, (ii) severe ground shaking (strong or long), (iii) earthquake and rumbling noise, (iv) earthquake and siren, (v) water recedes, or (vi) wall of water. If outside the evacuation zone, remain at home.</p>	<p>If inside the evacuation zone, walk out to evacuate if: (i) siren and instructions to evacuate, (ii) severe ground shaking (strong or long), (iii) earthquake and rumbling noise, (iv) earthquake and siren, (v) water recedes, or (vi) wall of water. If outside the evacuation zone, remain at work.</p>	<p>If inside the evacuation zone, walk out to evacuate. Evacuate if: (i) siren and instructions to evacuate, (ii) severe ground shaking (strong or long), (iii) earthquake and rumbling noise, (iv) earthquake and siren, (v) water recedes, or (vi) wall of water. If outside evacuation zone, remain at school.</p>	<p>If there is: (i) siren and instructions to evacuate, (ii) severe ground shaking (strong or long), (iii) earthquake and rumbling noise, (iv) earthquake and siren, (v) water recedes, or (vi) wall of water, then: (a) drive out of an evacuation zone (head mauka); (b) once out, park in nearest parking lot or along the curb or a clear side street and stay there; (c) don't block traffic or abandon your car in the middle of the road. If necessary, pull to the side and walk.</p>
<p><b>Alaska Arrival at 4-5 hours away</b></p>	<p>If inside the evacuation zone, evacuate when given instructions by the radio broadcast. If outside the evacuation zone, remain at home.</p>	<p>If inside the evacuation zone, evacuate when given instructions by the radio broadcast. If outside the evacuation zone, remain at work.</p>	<p>If inside the evacuation zone, evacuate when given instructions by the radio broadcast. If outside the evacuation zone, remain at school.</p>	<p>Listen to local radio for instructions. In general: (i) drive out of an evacuation zone (head mauka); (ii) once out, park in nearest parking lot or along the curb or a clear side street and stay there; (iii) don't block traffic or abandon your car in the middle of the road. If necessary, pull to the side and walk.</p>
<p><b>Chile Arrival 15 hours away</b></p>	<p>If inside the evacuation zone, evacuate when given instructions by the radio broadcast. If outside the evacuation zone, stay at home.</p>	<p>If inside the evacuation zone, listen to local radio as to when you should evacuate. If outside the evacuation zone, listen to local radio to determine if you should stay or when to leave.</p>	<p>If inside the evacuation zone, listen to local radio as to when you should evacuate. If outside the evacuation zone, listen to local radio to determine if you should stay or when to leave.</p>	<p>Listen to local radio for instructions. In general: (i) drive out of an evacuation zone (head mauka); (ii) once out, park in nearest parking lot or along the curb or a clear side street and stay there; (iii) don't block traffic or abandon your car in the middle of the road. If necessary, pull to the side and walk.</p>



**Table 3-3 Nature's Own Warning (NOW) Evacuation Signals for Low Lying Coastal Areas\***

Nature's Own Warning	Immediate Response	Comment
Feel strong earthquake - have difficulty standing	<b>Protect yourself. If in a building, Drop to hands and knees to protect yourself from falling, Cover your head and neck under sturdy table, desk or with arms and hands, Hold on to shelter. (Drop, Cover, Hold) Evacuate tsunami evacuation zone after shaking stops.</b>	Any strong shaking, as measured by difficulty in standing, requires you to protect yourself, then evacuate. This is top priority. If in doubt if the shaking is strong or not, evacuate.
Feel weak earthquake	<b>Become Alert</b> - Start counting the duration of shaking in seconds. Don't turn your back on the ocean, observe the water and listen for sounds. <b>Prepare to evacuate.</b>	Feeling an earthquake is likely the first sign you receive related to a locally-generated tsunami. <b>Yet not all earthquakes generate tsunamis.</b> People in the County of Hawai'i generally feel 2-3 earthquakes per year. Since 1901, there have been 6 locally generated tsunamis. <sup>14</sup>
Feel earthquake for more than 20 seconds	<b>Evacuate tsunami evacuation zone</b>	As soon as you feel weak shaking, pay attention to the duration by counting to 20 seconds. Pay attention to the ocean for unusual water changes or sounds.
Feel earthquake and rumbling noise from ocean - like thunder; truck noise or a jet airliner	<b>Evacuate tsunami evacuation zone</b>	Sound is often an early warning of imminent danger. <sup>15</sup> If there is no earthquake, the noise could be real thunder, a truck, or jet.
Feel earthquake and siren	<b>Evacuate tsunami evacuation zone</b>	If no earthquake is felt, the siren is your signal to turn on local TV and radio for further instructions and refer to the civil defense information in the front of your phone book.
Unusual disappearance of water; exposed reef	<b>Evacuate tsunami evacuation zone</b>	A later signal – ocean doesn't always recede. May provide enough evacuation time. Better to evacuate if have earlier signals.
Unusual wall of water	<b>Evacuate tsunami evacuation zone</b>	A later signal – wall of water doesn't always appear first. Even less time to evacuate.

\*Based on discussions with James Kanahikaua and Paul Okubo - USGS – Hawaiian Volcano Observatory; Daniel Walker, Senior Seismologist UH Mānoa, Retired and Tsunami Advisor to the Department of Emergency Management for the City and County of Honolulu; Charles McCreery and Gerard Fryer -Pacific Tsunami Warning Center, NOAA; George Curtis - University of Hawai'i and Hawai'i County Tsunami Advisor; and Walter Dudley, University of Hawai'i at Hilo.

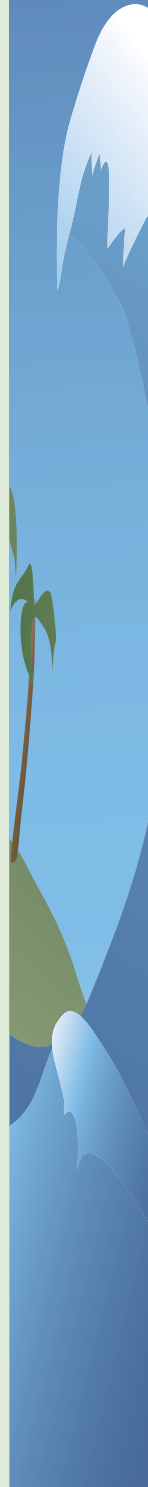



**To summarize tsunami evacuation:** Determine beforehand if you are in a tsunami evacuation zone (see: local county’s emergency management or civil defense website – Appendix A; or the front of the phone book – (The Official Hawaii Telecom Directory – current version). Evacuate if you are in the evacuation zone and one of following happen: **(i)** the siren sounds **and** local radio or television instruct you to evacuate; **or (ii)** you experience one or more of the **Evacuation NOW Signals:**

- (a) FEEL strong earthquake – difficulty in standing,
- (b) FEEL long earthquake – shaking over 20 seconds,
- (c) FEEL earthquake and HEAR rumbling noise,
- (d) FEEL earthquake and HEAR siren a few minutes after,
- (e) SEE water recede from ocean, or
- (f) SEE a wall of water approaching.

Not all earthquakes will generate a tsunami, so it is important to know the **Evacuation NOW Signals**. Use your senses to **FEEL, SEE and HEAR** if there are **Nature’s Own Warnings** to Evacuate **NOW**.

### 3.5 Preparations Before a Hurricane

The following are some precautions that should be taken well before a hurricane arrives.<sup>16</sup>

- Wedge sliding glass doors with a brace or broom handle to prevent them from being lifted from their tracks or being ripped loose by wind vibrations.
- Unplug all unnecessary appliances. Shut off gas valves.
- Turn refrigerators and freezers to their coldest setting.
- When planning to evacuate, shut off electricity and main switch, and gas and water at their main valves.
- Package valuables such as jewelry, titles, deeds, insurance papers, licenses, stocks, bonds, inventory, etc., for safekeeping in waterproof containers. Include these with other evacuation materials.

- Outside, turn down canvas awnings or roll them up and secure them with sturdy rope or twine.
- Check door locks to ensure doors will not blow away.
- Check outdoor items that may blow away or be torn loose; secure these items or move items such as potted plants inside.
- Store chemicals, fertilizers, or other toxic materials in a safe section or secure area of the premises.
- Secure propane tanks. They should not be stored near sources of heat (like the water heater or other appliances).
- Fill the gas tank of all cars.
- Deploy window protections well in advance of the arrival of any winds. For those that have already prepared plywood shutters, partial deployment could begin before there is any official hurricane warning. Closely monitor advisories, watches, and warning to guide timing of deployment (see Part 4).
- Ensure a sufficient amount of cash in hand to purchase goods and items if needed following the hurricane, as banks and ATM machines may be inaccessible because of a lack of electricity.

## 3.6 Evacuation Plan for a Hurricane

In developing an evacuation plan for a hurricane, decide whether to stay at home, go to a shelter, or go elsewhere (like a friend's or relative's house that is stronger, or work, if allowed). Stay in a place that is: (i) away from any flood or inundation risk, and (ii) able to withstand strong winds and rain. The plan should include all family members and pets. Emergency supplies and evacuation kit should already be in place at the beginning of hurricane season (See Parts 3.1 and 3.2).



There are a limited number of hurricane evacuation shelters and spaces that offer protection from wind, rain, and coastal waters. Since there is a shortage of shelters, plan to use a shelter only as a last resort. **When planning on using a shelter, make sure it is officially open. Listen to local TV and radio for the status of public hurricane shelters. Go to County Emergency Management or Civil Defense agency websites (Appendix A) for a list of potentially open shelters.**

Not all parts of a school serve as hurricane evacuation shelter. Follow the directions of personnel who are staffing the shelter. If there are no visible personnel, either the shelter is not open or only a part of the facility is being used for shelter. Once at a shelter, each person is given a maximum space of 10 square feet. There will be a bare floor. Evacuees must supply their own bedding, food, water, and other essentials, all of which should be included in a pre-packed evacuation kit (Part 3.2). Make the best of the situation and cooperate with the volunteers.

A better alternative is to strengthen your house and shelter in place. Staying at home to shelter from a hurricane makes it easier to store food and water and take care of loved ones, including those with special needs, the elderly, and pets. This is why it is important to strengthen your house with hurricane clips and window coverings if they are not already in. If there are limitations to your house, go to a friend's or relative's house that is stronger.

Sheltering in place is a personal decision. To help make the decision, the following instructions and guidance are provided. **Read these instructions carefully before hurricane season and before using the Shelter-In-Place-Table (Table 3-4).**

1. The Shelter-In-Place Table contains general guidance on what makes a house strong. Seek the advice of a licensed structural engineer to precisely determine the strength of your house and learn about the simple measures to retrofit. Each house is a little different.
2. Shelter in place in a house (**yours, friends, or relatives**) only if it is:  
(i) outside a high risk flood zone and there is no risk of flooding, (ii)

outside a hurricane storm surge zone (see Part 2.2 and Figure 2-6), and (iii) resistant to hurricane winds.

- 3. Flooding** - Do not shelter in place if the house is in a high-risk flood zone or has a risk of flooding. Use the Flood Hazard Assessment Tool (see Reference Link 32, Figures 2-12 and 2-13) to type in any address or tax map key number. If the house is in a high risk flood zone (VE, V, A, AE, AH, AO, or AEF zone), and a hurricane threatens, do not shelter in place. Even if the house is outside a high-risk flood zone, it may have a history of flooding. Do not shelter in place if the house is at any risk of flooding during a hurricane as indicated by prior history, or location near a stream, river, channel, water body, or low lying coastal area.
- 4. Storm Surge** - Hurricane storm surge maps (not to be confused with tsunami evacuation maps) can be found at <https://www.nhc.noaa.gov/nationalsurge>. Know beforehand if you are in a storm surge zone by scrolling and zooming into your location. Select the appropriate category of hurricane. If in doubt, go higher. Evacuate if the house is in a hurricane storm surge zone **and** when instructed to leave by local emergency management or civil defense agencies. Monitor local TV **and** radio carefully well before, during and after the event.
- 5. Wind** - Use the Shelter-In-Place Table to guide your decision. The stronger the wind, the stronger the house needs to be. Use the following as a guide:
  - a) Condition** - A house in good condition is free from termite damage, wood rot, and corrosion of fasteners. Maintain your house to make it stronger.
  - b) Hurricane Clips** - Generally, houses built after 1988 on O‘ahu, after 1990 on Maui and Kaua‘i, and after 1994 on Hawai‘i Island have hurricane clips which tie the roof to the wall and prevent it from blowing off (see Part 4). These requirements went into effect with building code changes after Hurricane Iwa in 1982.

- 
- c) **Continuous Load Path Connection** - Generally, houses built after 1993 on Kaua‘i, after 1994 on Hawai‘i Island, and after 1995 on Maui and O‘ahu have a continuous load path connection that ties the roof to the wall to the foundation (see Part 4). These requirements went into effect with building code changes after Hurricane Iniki in 1992. As a very rough generalization, houses built after 1995 are stronger than houses built before.
- d) **Windows, Roof, Garage, and Doors** - Other ways to strengthen a house are to protect windows from flying debris (masking tape will not work), fortify the roof, and brace garages and doors.
- e) **Retrofitting** - If a house does not have items b, c, or d, they can be added as a retrofit. Retrofit measures are in Part 4 of the handbook. This is encouraged as it will strengthen the house significantly and make it more viable for sheltering in place.
- f) To use the Shelter-In-Place Table, determine if the house is single-wall, double-wall (framed by 2” x 4” studs with drywall on the inside and siding on the outside), or has a concrete-wall. Concrete is strongest, then double-wall, then single-wall. (Remember the story of the big bad wolf and the three little pigs with houses built of straw, wood, and stone?). Determine what row applies to your house in Table 3-4, based on wall type.
- g) Once the applicable row is located, look at the options to the right to determine the current house characteristics: condition (a), hurricane clips (b), load path (c), window protection (d), retrofitting (e). Compare the current characteristics with the lower double-arrowed bar to determine whether to shelter in place or not. There are five categories: Unsafe, Marginal, Good, Better, and Best.
- h) **Do not overestimate the strength of your house during a hurricane.** There will also be unknown external risks. For example, a strong house can be damaged by a tall tree from a neighboring property. Wind speed can be amplified by topography, such as at ridge lines, in some cases over 40%. An

increase of wind velocity of 40% could effectively double the force on a building. Wind speed maps can be found in the report: “Guide to Strengthening of Hawaii Single Family Residences” (Reference Link 33).<sup>17</sup> The base effective flat land wind speed for Hawai‘i of 105 mph has been increased in some cases up to 140 mph or more due to topography.

- i) A homeowner’s goal is to assess the current condition of their house and the viability of sheltering in place. Always strive to strengthen the house and move the conditions to the right on Table 3-4, through continuous maintenance and retrofitting during hurricane season and especially out of hurricane season when contractors will not be over-booked. Do not miss out on the opportunity to significantly increase the strength of your house with minimal investment (see Part 4 for retrofit measures).
- j) Even if a house is not strong enough for a major hurricane (Category 3 or above), it pays to strengthen it over time and get hurricane insurance. Even if sheltering in a stronger house, building, or public hurricane shelter (that is announced as officially open on local TV or radio), you will be more likely to return to an intact structure. This is especially so for single wall homes, which can be significantly strengthened, but can be over-powered by a strong hurricane.
- k) When sheltering in place, always stay in the lowest floor and in the center of the house, **away from all windows**. If in doubt, go to another house such as a friend’s, relative’s, or neighbor’s that has a continuous load path connection and is outside any FEMA flood zone or storm surge evacuation zone. If you cannot find a suitable house, consider a friend’s, or relative’s high rise concrete building (preferably fourth story or higher for a building with ten stories or more). Use an open hurricane evacuation shelter as a last resort.

Table 3-4. Shelter-In-Place Guidance (please read instructions in Part 3.6)

		ABILITY TO SHELTER IN PLACE DURING A HURRICANE PLEASE READ INSTRUCTIONS BEFORE USING THIS TABLE				FEMA or Hawai'i Residential Safe Room
<b>Safe room</b>						Concrete CMU wall house with hurricane clips exceeding code & window protection
<b>Concrete or CMU wall house</b>	Concrete CMU wall house in poor condition	Concrete CMU wall house in good condition	Concrete CMU wall house with hurricane clips	Concrete CMU wall house with hurricane clips & window protection	Concrete CMU wall house with hurricane clips exceeding code & window protection	
<b>Double wall house</b>	Double wall house in poor condition	Double wall house in good condition	Double wall house with hurricane clips	Double wall house with hurricane clips, window protection, garage & roof reinforced	Double wall with complete load path & window protection, garage & roof reinforced	
<b>Single wall house</b>	Single wall house in poor condition	Single wall house in good condition	Single wall house with hurricane clips & window protection upgrades	Single wall house with clips, window protection and foundation upgrades	Single wall house with complete load path & window protection, garage & roof reinforced	
<b>Suggested Action</b>	<b>Unsafe</b> Evacuate! Do Not Shelter in place	<b>Marginal</b> Shelter in place up to a Tropical Storm	<b>Good</b> Shelter in place up to Category 1 hurricane	<b>Better</b> Shelter in place up to Category 2 hurricane	<b>Best</b> Shelter in place up to Category 3 hurricane	

\*Based on discussions and review with Ian Robertson, Professor, UH Mānoa, Civil and Environmental Engineering; Gary Chock, Structural Engineer, Martin & Chock Inc.; Tim Waite, P.E., Simpson Strong-Tie; and Kevin Richards, Natural Hazards Officer, Hawai'i Emergency Management Agency.



## 3.7 Evacuation Procedures for a Flood

The general rule when evacuating from a flood is to stay away from flood waters and head to higher ground. Stay away from moving water. Even six inches of water can make standing difficult or cause a car to stall. One to two feet of flowing water can move a car. If there is a flash flood and you are caught in your house, go to the second floor or the roof, if necessary.<sup>18</sup>

Around the state, there are many dams that could potentially flood or be overtopped during high rainfall events related to a storm or a hurricane. The risk of flooding from dam failures and incidents can occur even on sunny days with no rainfall because of other failure mechanisms such as internal erosion and earthquakes. Dam evacuation maps for state regulated dams have been developed by the County Emergency Management/Civil Defense Agencies. Everyone should know if they are in a dam evacuation zone, and the easiest way to tell is go to the State Department of Land and Natural Resources (DLNR) Flood Hazard Assessment Tool (Reference Link 32). Type in an address to obtain the flood zone for that location (see Figure 2-12 and 2-13) and whether it is in a dam evacuation zone (Reference Link 34). Evacuation maps are also available for download on the DLNR's Dam Inventory Management System ([dams.hawaii.gov](http://dams.hawaii.gov)). Information about whether to evacuate will come from local media (TV and radio).

## 3.8 Evacuation Procedures for an Earthquake

There is no warning before an earthquake occurs, since one can occur anytime without advance notice. According to the U.S. Geological Survey, if you are in your house during an earthquake, stay there. The U.S. Geological Survey also recommends the following: “Get under a desk or table and hang on to it, or move into a hallway or get against an inside wall. **STAY CLEAR** of windows, fireplaces, and heavy furniture or appliances. **GET OUT** of the kitchen, which is a dangerous place (things can fall on you). **DO NOT** run downstairs or rush outside while a building is shaking or while there is a danger of being hurt by falling or being hit by falling glass or debris.”<sup>19</sup>



If outside when an earthquake hits, get out in the open, away from anything heavy that could fall. If in a car, stop gradually and pull out of the way of traffic. Do not park on or under a bridge or near power lines, trees, or signs. Stay in the car until the shaking stops. After resuming driving, watch out for obstacles that may have fallen on the road. If in a hilly area, watch for landslides and boulders.

For general emergency information, contact state or local emergency management or civil defense agencies. Use them as a resource when planning and preparing an evacuation plan. Do not wait until an emergency when these agencies are responding to hundreds or even thousands of calls. For a list of emergency contacts and contact information, please see Appendix A.

Ideally, an evacuation plan should consider all hazards, including tsunamis, hurricanes, floods, earthquakes, and wildfire.

### 3.9 Summary

To help summarize Part 3, Table 3-5, provides for each hazard, the applicable risk maps, and course of action. For most cases, tuning to TV and radio for instructions from local Emergency Management or Civil Defense Agency is the first step. **However, it is important to consider what could be requested from government officials prior to an event as you develop your plan.** Thus, it is important to take the time to thoroughly understand Part 3 of this book, as well as all the tables in advance.

**Table 3-5. Evacuation Planning – Summary**

Hazard	Applicable Risk Maps	Action
<b>Tsunami</b> (Part 3.4)	Tsunami evacuation maps are available at your county emergency management or civil defense websites (Appendix A) or <a href="#">Reference Link 31</a> or the Official Hawaii Telecom Directory (current).	<ol style="list-style-type: none"> <li>1) Know your evacuation zones and make plans for a tsunami and extreme tsunami (Figures 3-1 and 3-2).</li> <li>2) Know where you will go if you are at home, work or school (Table 3-2).</li> <li>3) Outdoor Warning Siren – turn on local TV and Radio for instructions.</li> <li>4) <b>Evacuate when instructed.</b></li> <li>5) For a local tsunami, know <b>Nature's Own Warning Evacuation (NOW)</b> signs.</li> <li>6) (<b>FEEL</b> strong earthquake, <b>SEE</b> water move, <b>HEAR</b> noise from ocean (Table 3-3).</li> </ol>
<b>Earthquake</b> (Part 3.8)	See figures 2-10 and 2-11 to determine relative earthquake risk for each island.	<ol style="list-style-type: none"> <li>1) <b>Drop</b> to the floor, take <b>Cover</b> under a strong table, <b>Hold</b> on to it.</li> <li>2) When shaking stops evacuate structure.</li> <li>3) If in Tsunami Zone – evacuate to high ground.</li> </ol>
<b>Hurricane</b> (Part 3.6)	<ol style="list-style-type: none"> <li>1) Flood Hazard Assessment Tool <a href="#">Reference Link 32</a></li> <li>2) Hurricane Storm Surge Maps <a href="https://www.nhc.noaa.gov/nationalsurge/">https://www.nhc.noaa.gov/nationalsurge/</a></li> <li>3) Wind Topography Maps <a href="#">Reference Link 33</a></li> </ol>	<ol style="list-style-type: none"> <li>1) Do not shelter in a high risk flood zone, a storm surge zone, or if any flooding risk.</li> <li>2) Before hurricane season, know if your house is subject to flooding, storm surge or wind speed up. Plan if you will shelter in place, go to a stronger structure, or use a public shelter as a last resort.</li> <li>3) Use the Shelter-In-Place Table and Instructions to determine if your structure is strong enough for the wind (Table 3-4).</li> <li>4) <b>Evacuate when instructed by local officials.</b></li> </ol>
<b>Flood</b> (Part 3.7)	1) Flood Hazard Assessment Tool <a href="#">Reference Link 32</a>	1) Stay away from floodwaters – <b>“Turn Around, Don’t Drown”</b> (Section 3.7).
<b>Dam Evacuation</b> (Part 3.7)	<ol style="list-style-type: none"> <li>1) Flood Hazard Assessment Tool <a href="#">Reference Link 32</a></li> <li>2) DLNR Dam Inventory <a href="https://dams.hawaii.gov">dams.hawaii.gov</a></li> </ol>	<ol style="list-style-type: none"> <li>1) Know if you are in a dam evacuation zone. See the guide (Reference Link 34).</li> <li>2) <b>Follow instructions from local officials on TV and radio</b> (Section 3.7).</li> </ol>
<b>Wildfire</b> (Part 2.6.1)	<ol style="list-style-type: none"> <li>1) Monitor drought conditions for your county <a href="http://dlmr.hawaii.gov/drought/">http://dlmr.hawaii.gov/drought/</a></li> <li>2) Determine relative risk of wildfire in your location (Figure 2-19 and 2-20).</li> </ol>	<ol style="list-style-type: none"> <li>1) <b>Evacuate when instructed by local officials – “Ready, Set, Go.”</b></li> <li>2) Protect property by creating firebreak space around home, clean debris from roof and gutters regularly, etc.</li> </ol>
<b>Lava</b> (Part 2.5)	See Figure 2-15 <a href="https://volcanoes.usgs.gov/observatories/hvo/">https://volcanoes.usgs.gov/observatories/hvo/</a>	1) <b>Evacuate when instructed by local officials.</b>

*For all evacuation scenarios, including man-made threats, your evacuation kit should be ready to go (Part 3.2). Plan ahead. Listen to local TV, radio, fire and police for instructions. See your county emergency management or civil defense agency websites (Appendix A).*





## Part 4

# Protecting Property

Protecting property and protecting family go hand in hand, since a strong house may be able to provide shelter from most weather conditions and perhaps even severe conditions. By strengthening important elements of a house, it may be safe to shelter in place during a hurricane. The amount of protection a house can provide is limited by a number of factors, some of which are listed below:

**1) The severity of the hazard event:** Protecting against a tropical storm or Category 1 hurricane will be much easier than against a major Category 4 or 5 hurricane (see Tables 2-2 and 3-4). For stronger storms, eliminating all damage is not possible, and the major goal is to lessen the amount of damage significantly. Fortunately, stronger storms are thought to occur less frequently. Also, many small improvements can make a difference to house strength, so everyone is encouraged to work on their home.

**2) House location:** Even though a hurricane may be a Category 1, much stronger winds could impact the house, depending on the geographic setting. Being on a ridge, for example, amplifies the wind speed. Wind maps have been created for each island that show how topography affects wind speed (see Part 3.6 and Table 3-5).<sup>17</sup> These maps are now part of the new State of Hawai‘i Building Code that was adopted on November 13, 2018.

**3) House construction:** Today, county building codes require new houses to have hurricane clips that tie the roof to the wall and other connectors that tie the wall to the foundation. This is known as a “continuous load path connection” (see Figure 4-1). Because of these requirements, houses today are generally much stronger than those built before this requirement was in effect (see Table 4-1).

**4) House maintenance:** Maintenance of a house’s skeleton and exterior is important. Painting the exterior every five years protects the wood and prevents rot, which can weaken the structure. Termites can also weaken a wood-framed house. If the wood in the house is rotten or has severe termite damage, it will be more difficult, or even impossible, to strengthen the house

in a retrofit. So, it is important to perform routine maintenance by periodic painting and eliminating termites. Proper maintenance will extend the life of a house in more ways than one.

**5) House improvement:** Even if a house was not built with double walls or hurricane clips, there are many small steps and some major ones that can be taken to address how it was initially built and further fortify it. Part 4 concentrates on many of the concepts and measures that can be implemented to strengthen any house, as well as some programs in place that provide incentive to act.

Past events can act as a useful guide in deciding on the most cost effective ways to strengthen a house. When Hurricane Iniki struck Kaua‘i in 1992, over 41 percent of the island’s 15,200 homes were damaged or destroyed. An approximate breakdown is shown below:

- 1,100 homes totally destroyed
- 1,000 homes were damaged severely (more than 50 percent damage to structure)
- 4,200 homes were damaged moderately (15–50 percent damage to structure) or minimally (less than 15 percent damage to structure)<sup>20</sup>

For many homeowners, even minor damage of 15 percent or less can be an extreme hardship. Because the islands of Maui, Hawai‘i, and O‘ahu have almost two to eight times the number of houses as Kaua‘i did before Iniki, the risk of catastrophic damage on those islands is much greater. **A 2018 study by the Pacific Disaster Center after Hurricane Lane indicates that a Category 1 hurricane could severely damage at least 3,800 homes, displacing all their residents, and a Category 2 could displace up to 52,000 households on O‘ahu, when increased wind speed from topography is considered (Reference Link 1).**

After Hurricane Iniki, FEMA conducted an assessment of building performance on Kaua‘i.<sup>21</sup> Two key statements from the report follow: ***“Incomplete design and construction for load transfer and improper connections, especially between roof and walls, were found to be the most important factors causing structural failure of buildings due to uplift wind***

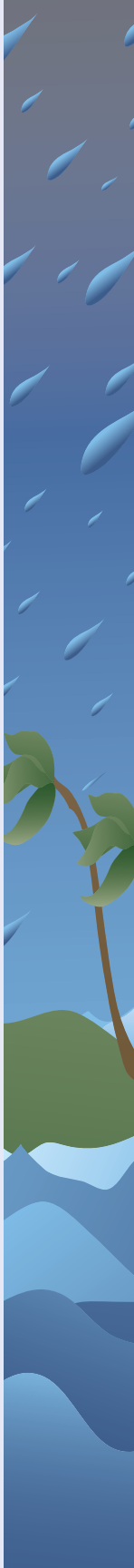



**forces.” This statement relates to Concept 1: Creating the Continuous Load Path Connection and tying the roof to the wall with hurricane clips to significantly reduce the risk of structural failure of the whole house.**

***“In many instances, loss of glazing (e.g., glass doors and windows), either from direct wind pressure or from debris impact, resulted in breach of the building envelope, subsequent internal pressures, and progressive structural failure.” This statement relates to Concept 2: Creating a Wind- and Rain-Resistant Envelope by protecting the openings around the house, such as windows.***

Had the impacted houses on Kaua‘i been properly designed and fitted with hurricane clips, wall-to-foundation connections, and window protection, perhaps hundreds of homes that were destroyed could have been saved, and thousands that suffered severe, moderate, or minor damage may have instead had moderate, minor, or no damage, respectively.

The importance of having these features was also shown in site visits to Rockport, Texas where Hurricane Harvey made landfall as a Category 4 hurricane in 2017. Newer houses built under modern building codes with a strong load path connection and protection of the envelope performed better and survived major wind damage, even for double-wall wood frame houses.<sup>22</sup> Thus it is important for Hawai‘i to implement strong building codes for new houses that include the load path and window protection.

For older homes with single-wall construction, it is difficult to retrofit them to be as strong as a new house built under modern building codes. However, it is possible to strengthen them significantly, helping them to survive a tropical storm or even a category 1 or 2 hurricane. This will substantially reduce the risk of hurricane damage since the stronger events (Major Category 3, 4 or 5) are less probable in terms of frequency of occurrence (Reference Link 35, 36).

Even for a Major Category hurricane, the swath of most damage associated with the eye wall (10-15 miles in diameter) is a small part of the overall hurricane structure. If the eye of a Category 3 hurricane passed over west O‘ahu, single-wall houses fortified on east O‘ahu would have a good chance of survival. For older double-wall homes, the ability to strengthen them

is even greater. Thus, almost every house in the state can and should be retrofitted to make them stronger.

Since there is the potential to prevent significant hurricane damage, as well as a great need, a major portion of Part 4 covers: (i) Completing the Continuous Load Path Connection as much as possible, and (ii) Protecting the Wind-and Rain-Resistant Envelope around your house.

The importance of these measures is stated in the FEMA Damage Assessment Report for Iniki and reflected in the discounts in hurricane insurance premiums provided by many companies for their implementation (see Part 5). Furthermore, new houses built under the Hawai‘i State Building Code, which was adopted on November 13, 2018, will eventually be required to have many of these measures. One goal of Part 4 is to explain to homeowners the many practical measures that can be put into existing homes through retrofit to make them stronger.

**Typical homeowners may be able to perform much of the work for many of these measures. However, if the work is beyond in-house capabilities, consider hiring a licensed contractor, structural engineer, and/or architect. Even if the reader does their own work, it is best to contact a licensed structural engineer or architect first to obtain initial guidance and details specific to each house. Each house is a little different.**

## 4.1 Concept 1: Continuous Load Path Connection

The continuous load path connection concept is illustrated in Figure 4-1. The load path provides a continuous connection between the roof and the house’s foundation and helps to keep the roof from blowing off during a hurricane. The continuous load path connection is analogous to a chain: both are only as strong as their weakest link. Historically, the weakest link has often been the roof-to-wall connection. Thus, the hurricane clip was created.

Naturally, all houses have some connection from the roof to the foundation; otherwise they would fall apart. However, only after examining damage from Hurricanes ‘Iwa in 1982 and Iniki in 1992 were much stronger connections required in the form of straps, anchors, and hurricane clips to protect against hurricane winds, as depicted in Figure 4-1.



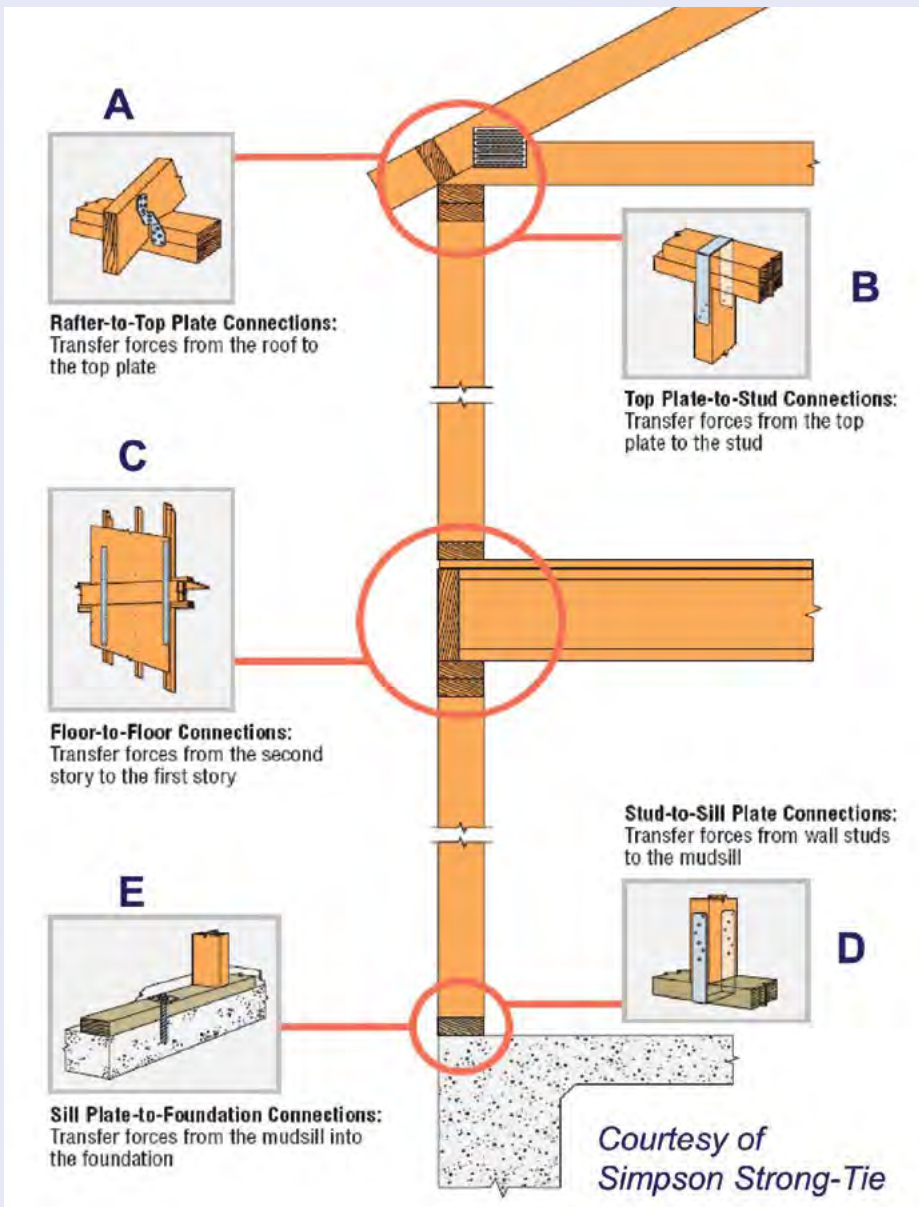

**Figure 4-1.** The continuous load path connection ties: (i) the roof rafter to the wall (double-top plate) with hurricane clips (A); (ii) the double-top plate to the studs (B), the walls of any higher story to the lower story (C), and the studs to the bottom sill plate (D) with metal strips; and (iii) the bottom sill plate to the foundation with anchor bolts (E). These connections are in new homes so that the roof does not blow away. Older homes will not have these features (see Table 4-1). The goal of retrofit measures in this part is to add as much of the continuous load path connection as possible, within reason, starting from the top and working down.



According to the State Department of Commerce and Consumer Affairs Report “Guide to Hurricane Strengthening of Hawaii Residences” (Reference Link 37), houses are likely to have the following levels of hurricane protection based on the given benchmark dates:

**Table 4-1. Key Dates for Homeowners to Know Regarding Hurricane Protection**

County	Date likely to have hurricane clips	Date likely to have complete load path, including hurricane clips
Kaua‘i	Plans dated 1989 or later; built after 1990	Plans dated 1992 or later; built after 1993
O‘ahu	Plans dated 1987 or later; built after 1988	Plans dated 1994 or later; built after 1995
Maui	Plans dated 1989 or later; built after 1990	Plans dated 1994 or later; built after 1995
Hawai‘i	Plans dated 1993 or later; built after 1994	Plans dated 1993 or later; built after 1994

It is very important to know if a house has: (i) no hurricane clips; (ii) hurricane clips only (column 2); or (iii) hurricane clips along with the complete load path connection (column 3). Check with an architect, home builder, or developer to determine how a particular house was built, especially if the construction time falls in one of the transition periods.

New houses have the complete load path connection. For older houses, it is possible to retrofit them and add components of the connection (see Figures 4-2 through 4-6). Each house is different but, in general, it will be easier and less expensive to install hurricane clips than to construct the foundation connection. Check with a licensed architect, or structural engineer to determine what is feasible in each situation. In some cases, given the willingness to spend the time and having proper direction from a licensed structural engineer or architect, a homeowner may be able to properly install the hurricane clips themselves. See the step-by-step guide in the next section for installing the Simpson Strong-Tie Hawaii Plantation Tie (HPT) clip. Other portions of this work, namely the foundation connection, will most often require the work of a licensed contractor. There are financial incentives offered by some insurance carriers to perform this work (see Part 5 on Insurance), but certain guidelines must be followed to be eligible.





**Figure 4-3.** This is the popular H2.5 hurricane clip installed during new construction of houses. Five nails are hammered into the lower beam (or top plate) and five more need to be used for the roof (truss-rafter) connection. A hurricane clip is required for each truss-rafter. Upon completion of this structure, the hurricane clip will be hidden from view. This particular clip costs 30 cents. For less than one dollar in material cost, stronger ones can be installed for both new and retrofit applications.

**Figure 4-4.** This is an example of retrofitting an existing house, originally built without hurricane clips. The popular H3 clip is used here; four nails attach the clip to the roof (truss-rafter) and four more nails attach to the wall or top plate below. For a retrofit, the clips are exposed on the outside of the house. Therefore, both the clip and fasteners should be corrosion resistant and painted to blend with the exterior of the house. With the correct clip and nails, a homeowner could perform the work or hire a licensed contractor.<sup>23</sup>



**Figure 4-5.** In this retrofit example, a hurricane clip attaches the roof structure to a horizontal ridge beam, which is in turn attached to the vertical post with a metal strap. This is an attempt to tie the load from the roof to the foundation, or create the complete load path connection. Note that these clips and straps are in the process of being painted. Photo courtesy of Hurricane Protection Services.



**Figure 4-6.** In some retrofit examples, it is possible to tie a portion of the house to the foundation. Here, a metal strap connects the vertical post to the foundation, which attempts to finish the continuous load path connection from the roof to the foundation. Photo courtesy of Hurricane Protection Services.

Homeowners should consult with a licensed structural engineer or architect if retrofitting is being performed by the homeowner or a licensed contractor. The structural engineer can go over the costs and benefits of installing the following:

1. Roof-to-wall connections (see Section 4.1.1);
2. Other connections to complete the load path (see Section 4.1.2);
3. Wall-to-foundation connections (see Section 4.1.3);
4. Stronger connectors than those required in the current building code; or
5. Using connectors to transfer the load path around windows and doors. The more connections that tie the roof to the foundation the better, but the connections around windows and doors are sometimes incomplete (see FEMA documents - Home Builder's Guide to Coastal Construction P-499 and Local Officials Guide for Coastal Construction P-762). Generally, the first step for houses without hurricane clips (Table 4-1) is to add them as a retrofit.

## 4.1.1 Guide to Installing the Hawai'i Plantation Tie Hurricane Clip

The two most important things to strengthen a house are (1) to add hurricane clips; and (2) protect the openings of the house, such as windows (see Part 4.2). This is indicated by the FEMA Building Performance Assessment Team Report after Hurricane Iniki, and is reinforced by most hurricane insurance companies. Many offer discounts for installing hurricane clips and providing window protection (discounts may also be available for strengthening the wall-to-foundation connection, but this is often more complicated and harder to do as a retrofit). The evolution of the building codes reaffirm the need for hurricane clips and window protection, as over the years, the codes have changed to require these items. For example, hurricane clips began to be required between 1988 and 1994, depending on the island, after Hurricane 'Iwa. The continuous load path connection with hurricane clips was added between 1993 and 1995, depending on the island, after Hurricane Iniki. The continuous load path connection with hurricane clips and window protection (or a safe room) are now required in the Hawai'i State Building Code adopted on November 13, 2018, which all state counties must amend and adopt or follow within two years (Reference Link 38).

For houses without hurricane clips, it is encouraged that homeowners add them to prevent the roof from blowing off (see Figure 2-5). Every house in Hawai'i should have clips, as it has never been easier to add them. The HPT clip now makes it possible to fit hurricane clips from the roof to the wall on many houses, including single-wall houses with tongue and groove redwood framing or houses with angled or protruding blocking between the trusses or rafters (Reference Link 39). For houses that do not have protruding blocking, the easier-to-install H3 clip can be used. A licensed contractor can be hired to do the work or the homeowner can do it themselves. On O'ahu and Maui, estimates for installation by a contractor are about \$2000 for a small, single-wall house. Some insurance companies may also give a \$200 yearly discount on hurricane insurance premiums.

Figure 4-1(A) illustrates the roof-to-wall connection that clip installation will target, and Figures 4-7 and 4-8 show the specifications on the installation of the clip, as well as the roof rafter-wall connection terminology.

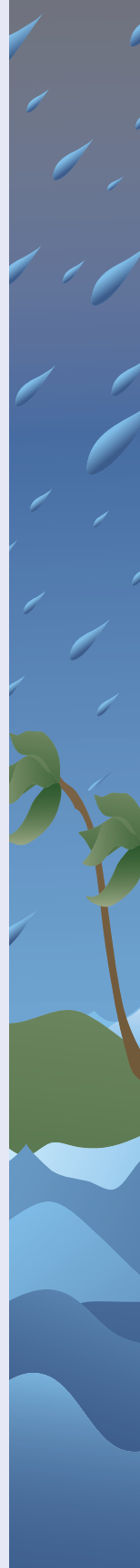



Prior to installation, however, it is good to keep a few tips in mind:

- **Consult a licensed architect or structural engineer to confirm the specifications and work for the specific property, as the guidelines in this book are for general installations and details may differ.**

- Only perform these installations if sufficiently capable. The task is not difficult but time and labor will be required. If possible, have two people work together for greater efficiency and enjoyment. It is a fun and worthwhile family project. Time and cost estimates in this book are provided, but proceed at a comfortable and steady pace to make progress each week. A full installation is not something that can be easily done when a hurricane watch is already in effect.

- Always remember safety. Eye protection from goggles and hearing protection from ear plugs or ear muffs are highly recommended. Be sure ladders are sturdy and in good condition, and read and follow all safety and OSHA instructions on the ladder before use.

- Good equipment will make the job more efficient and enjoyable, but no professional construction grade tools are necessary. Modern tools for the homeowner from the hardware store will suffice.

- The HTP clip has a galvanized coating and costs about \$1 each (Reference Link 39). This zinc coating is meant to sacrifice itself over time to spare the steel underneath. However, it is advisable to supplement with additional protective coatings over the HPT clip, followed by colored paint to match the house rafter. This process can be done with:

- (i) Zinc-Rich Cold Galvanizing Compound in one coat before installation and one coat after installation.
- (ii) Universal Bonding Primer suitable for galvanized metal in one coat after installation.
- (iii) High-Performance Enamel paint in two coats after the clips are installed to help further protect the clips and fasteners and make them aesthetically pleasing.

Rustoleum sells these in spray cans which are quick to apply and dry in 15 minutes. As an alternative, some contractors prefer to use an air-dry rubberized coating such as Plasti Dip. All of the above mentioned products are readily available at a local hardware store and typically under \$10 per can. For installations in salt-spray zones near the coast, stainless steel clips would be preferable for extra protection. For stainless steel clips, no extra coating is recommended, but all fasteners should be stainless steel also. Never mix metals (e.g., galvanized clips and stainless connectors, or vice versa).

- There may be some houses where a trim board is missing or not of sufficient size to support the HPT connection to the wall of the house (see Figure 4-9). In such cases, any trim or molding will need to be removed and replaced with a 1 inch by 4 inch trim board. This is easily accomplished using a wood blade from a multi-tool and a nail-trim remover (see Figure 4-10).

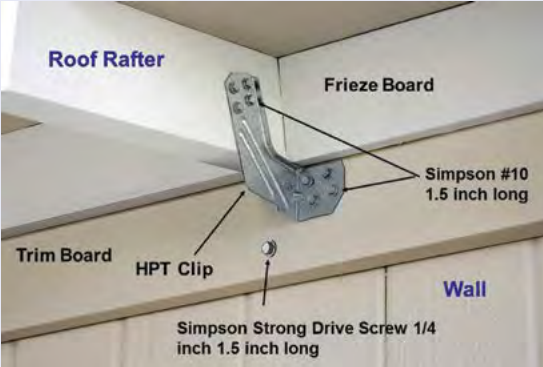

Figure 4-7. The Simpson HPT clip connects the roof rafter to the wall. Because the frieze board protrudes and is at an angle to the wall, the simpler-to-install H3 clip cannot be used (see Figure 4-4). Note the edge of the individual tongue and groove boards for this single wall house. The #10 and 1/4 inch screws are screwed into the same board as the HPT clip.

Figure 4-8. For the simple installation in Figure 4-7, a right angle impact driver (A) is used to install the manufacturer’s specified connections. Eight Simpson #10 wood screws with 1.5 inch length (B) are used for the top tab (roof connection) and the bottom tab (wall connection). In addition, one 1/4 inch Simpson screw with 1.5 inch length (C) provides connection from the trim board to the wall. The HPT clip (D) is shown in its original state, and also primed and painted for the use with black rafters.



When installed properly, the clips provide 400 lbs. of uplift protection per rafter. Thus, even the roof of very old single wall houses can be tied down to the requirements of the building codes put into effect after Hurricane 'Iwa (1988 to 1994, depending on the island; see Table 4-1). Although new building codes in 1995 and later will require even higher standards, this is nevertheless significant additional protection for older homes. For most single-wall houses, two people can do the simple installation in two or three Saturdays with a material cost of under \$300, excluding power tool costs. For those that do not have the time, companies performing this work may be able to do the work for about \$2,000 or under. Costs will vary depending on the island, the size of the house, and the number of stories.



**Figure 4-9.** In this more difficult installation, the molding needs to be removed and replaced with a trim board so that the 1.5 inch screws don't penetrate through the wall of the single wall house, which is typically  $\frac{3}{4}$  to  $1\frac{1}{8}$  inch thick.

**Figure 4-10.** In the case where the molding needs to be removed, this can be easily done with a multi-tool (E) and a nail-trim remover (F).



**Figure 4-11.** The old trim has been pulled. The new trim is 1 inch x 4 inch exterior wood, treated for termites, painted with primer and two coats of paint that color match the wall. Color matching can be done by taking a small sample to your local hardware store.





**Figure 4-12.** With the proper trim, the HPT clips can be installed as shown in Figures 4-7 and 4-8. Every rafter is connected to the wall in an esthetically pleasing manner. Adding trim is not hard to do, but will double the installation time. Two people working on this project can complete the job in 3-4 days.

**Summary:** Almost every single-wall house in the state can be strengthened with hurricane clips to prevent the roof from blowing off (see Figure 2-5). The simplest installation is to add the H3 clip, in cases where the trim board and frieze board do not interfere (see Figure 4-4). If the H3 clip is used with nails, an auto hammer or palm nailer would speed installation. The H3 clip can now also be installed with SD9 x 1-1/2 screws for an easier installation. Where there is protrusion of the frieze board, the HPT clip can be installed in most cases with little preparation (see Figures 4-7 and 4-8). In the rare case where the trim board is not of sufficient size, it should be replaced before installation (see Figures 4-9 to 4-12). While this installation is a little more time consuming, it is still straight forward and a worthwhile family project. A licensed contractor can also do the work, and estimates on O‘ahu and Maui are currently about \$2,000.

### 4.1.2 Wall-to-Foundation Connection

Adding the H3 or HPT hurricane clip to tie the roof to the walls provides significant protection. The homeowner can then attempt to complete the continuous load path connection on single-wall houses by tying the wall to the foundation. Many single-wall houses around the state are on post and pier foundations, which are susceptible to damage from earthquakes and hurricane uplift forces. With new materials and methods, it has never been easier to strengthen these structures by retrofit.

What follows in this part is a description of this retrofit, which is applicable to single-wall houses on post and pier foundations, especially those on Maui and Hawai‘i County, which have equal hurricane risk but increased seismic risk (see Figure 2-11) so shear walls may also be required.

To see what the work entails, review Figures 4-13 to 4-18. Figure 4-18 consists of 12 representative slides for a demonstration project on O‘ahu found at the Hawai‘i Homeowner’s Handbook website.

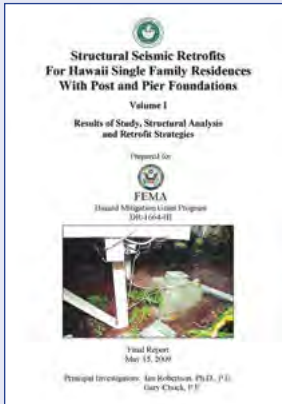

Figure 4-13. The reader is referred to the 2009 report by Dr. Ian Robertson and Gary Chock entitled *Seismic Retrofits For Hawai‘i Single Family Residences with Post and Pier Foundations*<sup>24</sup> (Reference Link 40). Using the methods in the 2009 report, and new connectors by Simpson-Strong Tie, a demonstration project for O‘ahu was completed in 2018 (Reference Link 41). See also the Post Demonstration Project Evaluation and Assessment Report conducted in 2018 (Reference Link 42).<sup>25</sup>

Figure 4-14. This shows the typical post and pier foundation structure found in many single-wall houses in Hawai‘i. The floor of the house is supported by joist and girders. The girders are supported by a post, typically 4” by 4” which sits on a termite pan, then a tofu block (small concrete square) and then the pier (larger concrete square). The connection between the post, termite pan, tofu block and pier is by friction only, with no metal connectors. This is satisfactory during normal conditions, but during an earthquake or hurricane the post can easily be knocked off their blocks. Photo courtesy of Don Thomas, University of Hawai‘i - Hilo.

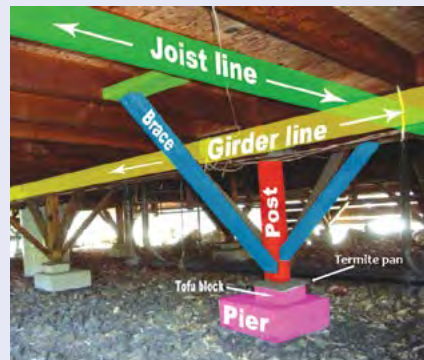
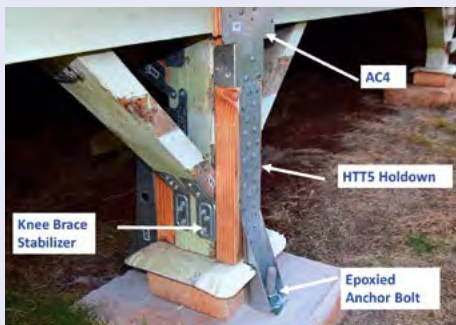
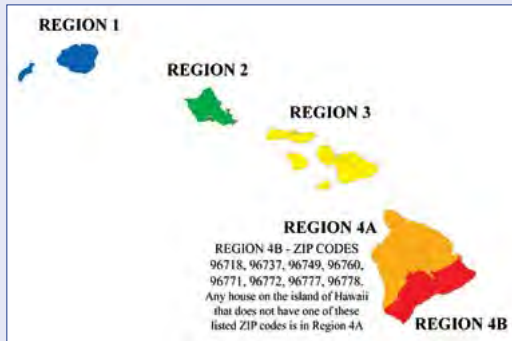

Figure 4-15. Damage after the October 15, 2006 Kiholo Bay Earthquake (see Figure 2-10). This post was shaken off the termite pan and tofu block (Reference Link 43). While the major emphasis for an earthquake is horizontal or lateral loads from shaking of the ground, often a retrofit for lateral loads, such as anchorage of the foundation posts will also be effective in resisting lateral and vertical loads caused by hurricane strength winds. Once anchorage to the foundation posts is performed, the weight of the house itself will provide some vertical uplift protection. The key is to keep the foundation posts properly anchored.

**Figure 4-16.** The post and pier retrofit design depends on many factors, the key being the seismic zone the house is located in (see also Figure 2-11). Other factors include the proximity to the coast, number of stories, spacing between the posts and the ratio of the tallest and shortest post. Refer to the reports cited in the caption for Figure 4-13. Consult with a licensed structural engineer before beginning this work. This retrofit is of medium difficulty but can be done by a handy homeowner. Otherwise hire a licensed contractor.



**Figure 4-17.** The goal of this retrofit is to fortify the post with 2" x 4" scabbing and connect the girders to the large concrete pier. A Simpson Strong-Tie ("SST") AC4 is used for 4" x 4" post to tie the girder to the post and scabbing. An HTT5 Holdown ties the scabbing and post to the concrete pier. The HTT5 is anchored to the concrete pier with an epoxyed anchor bolt. The braces are stabilized with SST Knee Braces. What follows in Figure 4-18 (a-l) are the steps to do this sample installation.



e



Install Simpson Strong Tie AC4 connector to inside post and beam. The AC4 is for 4" x 4" post. AC6 is for larger posts.

Use 3.5 inch 16d nails and a palm nailer. A hammer can be used but it is tiring and time consuming.



f

Knee brace stabilizer (Simpson KBS1Z) installed for all knee braces.



g



Trace outline of holdown on termite pan.

Cut termite pan with snips.



Fold down or hammer down termite pan against tofu block. Do for inside and outside.

h



Attach 2" x 4" between post and edge of tofu block.



Attach Simpson HDU2 holdown to 2" x 4" and concrete foundation.

i



Repeat process for outside of post with 2" x 4"



Attach HTT5 holdown to 2" x 4" and concrete foundation.

j

Drill hole with rotary hammer, clean hole of dust with air spray and brush. Then fill with epoxy. If epoxy used – drill hole is 1/8" larger than anchor bolt. Set anchor bolt and holdown.



k

The Titen concrete anchor screw eliminates the need to epoxy. Drill hole with rotary hammer - same size as anchor screw (e.g., 5/8" hole for 5/8" anchor). Drill anchor screw with impact driver. Treat for corrosion with zinc rich galvanizing spray, primer for galvanized metal and enamel paint.



l



Single-Wall House with Load Path!!

HPT hurricane clip on each rafter. See Part 4.1.1 of the Homeowner's Handbook on procedures.

Each exterior post retrofitted. See Part 4.1.2 of the Homeowner's Handbook on procedures.



The retrofit highlighted in this part ties the wall to the foundation and provides protection from both the vertical forces of the wind trying to lift off the roof and the lateral forces of the wind or earthquake pushing against the walls of the house. For the house in this demonstration project, the hurricane insurance premium dropped from \$1,184 to \$932 per year due to the reduced hurricane risk. Not all insurance carriers will offer discounts for retrofits, so it is important to review all aspects of the current hurricane insurance policy (see Part 5).

Refer to the 2009 Report, 2018 Demonstration Project, and 2018 Post Demonstration Project Evaluation and Assessment cited in the caption for Figures 4-13 to work out the details for the particular house. **A licensed structural engineer should be consulted before work begins. For counties of Maui and Hawai‘i, retrofit spacing would likely need to be increased and shear walls at the corners added.**

**Summary:** Single-wall houses with post and pier foundations can be significantly strengthened with a retrofit design that provides protection from the horizontal forces of hurricane winds, and some protection from the vertical forces. Homeowners can also do a more extensive retrofit which provides greater protection from horizontal and vertical forces. These retrofits should be considered for single-wall, single-level houses and is especially beneficial for houses on the islands of Maui and Hawai‘i. It may turn out that the retrofit is cost-efficient for houses on O‘ahu and Kaua‘i because of the significant additional, but not complete, protection provided against hurricane winds. With the addition of the hurricane clip in Section 4.1.1 and the wall-to-foundation improvements in this section, many existing houses can be significantly strengthened by completing as much as reasonably possible of the continuous load path connection.

### 4.1.3 Continuous Load Path for Double-Wall Houses

Double-wall houses are those that are framed by 2 by 4-inch studs and have, as the name implies, two walls: typically dry wall on the inside and an exterior wall consisting of manufactured siding. In the past, it has been difficult to retrofit double-wall houses. Unlike single-wall houses where the intersection of the rafter and wall are readily exposed from the outside, the intersection of these components in a double-wall house is hidden by





siding (the second wall). A new product from Simpson Strong-Tie called the SDWC Structural Screw solves the retrofit problem because the screw is driven past the exterior siding to reach the target structural components (see Figures 4-19 to 4-31 and Reference Link 44).

The purpose of this retrofit is to strengthen existing roof (truss) to wall (double-top plate) connections for existing homes in the situation where:

- (i) there are no hurricane clips since they were not required (generally houses built on or before 1988 on O‘ahu, on or before 1990 on Maui and Kaua‘i, and on or before 1994 on Hawai‘i; see Table 4-1);
- (ii) there was poor installation of hurricane clips with nails missing;
- (iii) there are hurricane clips on every other rafter under older building codes; or
- (iv) there was proper installation of clips with less capacity (H2.5s or H3s), associated with building codes from the 1990’s to the mid–2000’s, depending on location and wind zone.

Regarding the last three situations (ii, iii, and iv), it is possible to have both the hurricane clip and the SDWC since the clips connect the truss to the double-top plate externally while the SDWC connects the members internally (see Figure 4-21).

This retrofit can also help to continue the load path downward, to the greatest extent possible, in the situation where houses were built with hurricane clips but not a complete load path (e.g., houses generally built between 1989 and 1995 on O‘ahu, between 1991 and 1995 on Maui, between 1991 and 1993 on Kaua‘i and built on or before 1994 on Hawai‘i (see Table 4-1). What follows now is a photographic demonstration of the SDWC retrofit for a double-wall house in three parts: (i) truss to double-top plate connection, (ii) double-top plate to stud connection, and (iii) stud to bottom plate.

**Any homeowner may be able to perform the work themselves, but they should first seek the advice of a licensed structural engineer and**

architect (especially one familiar with the property). This is a relatively straightforward retrofit given the proper guidance. The structural engineer can cover certain aspects of the continuous load path while the architect is especially versed with the envelope of the house (e.g., siding, house wrap, and spacing).

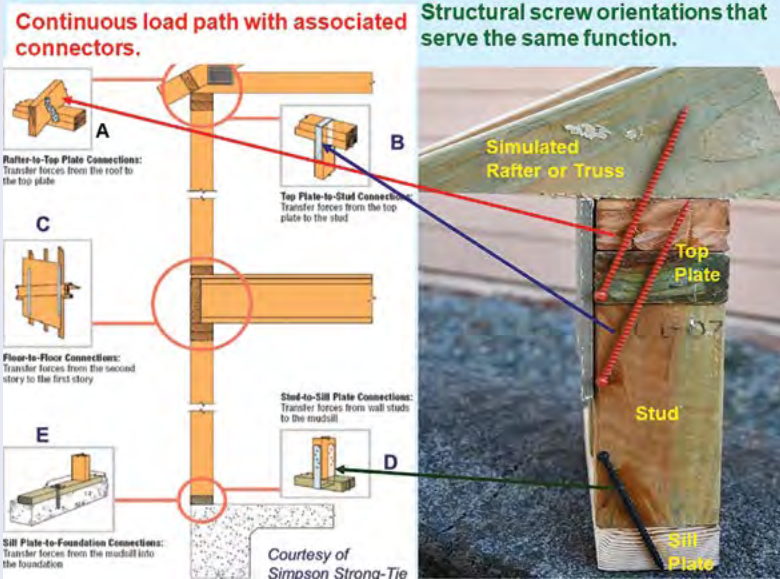

Figure 4-19. The reader should understand Figure 4-1 and the caption for the key connections that create a continuous load path connection. In this figure, the orange structural screw SDWC 6” (6 inch) ties the Top Plate and Simulated Rafter or Truss performing the same function as the hurricane clip (Connection A). The SDWC tying the Stud and Top Plate can take the place of Connection B. The SDWC tying the Stud to the Sill Plate could replace Connection D. This is possible because the SDWC can drill through the siding.

Figure 4-20. SDWC Structural Screws at a new construction job site on O’ahu. Their use was approved by the building department, building inspectors, and the project structural engineer to meet current building codes. The screws can also be used as a retrofit on existing double-wall houses as shown in this demonstration. The 6” orange SDWC screw can tie the truss to the double-top plate and the double-top plate to the stud (Connections A and B) in Figure 4-19. The 4.5” black SDWC screw can be used to tie the stud to the single-sill plate (Connection D).





**Figure 4-21.** For this double-wall house, the H2.5 hurricane clip (see Figure 4-2), ties the truss to the double-top plate. Ideally, 5 nails should be in the top tab and 5 on the bottom. This clip was installed in 1992 as a building code requirement at the time of construction from the interior of the house before any walls were installed. To the right is the orange SDWC, drilled from the outside of the house through the siding in 2018. It purposely missed the truss for illustration purposes. Moving the screw to the left by 6 inches would serve the same function as the H2.5 and tie the double-top plate and truss. Thus, it is possible to install the SDWC even if there are existing hurricane ties such as the H2.5. This can serve to strengthen the connection when there are no hurricane clips, clips that are poorly installed, or even clips that are properly installed but of less capacity.

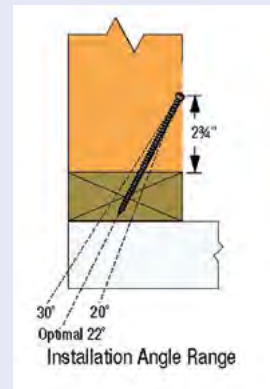
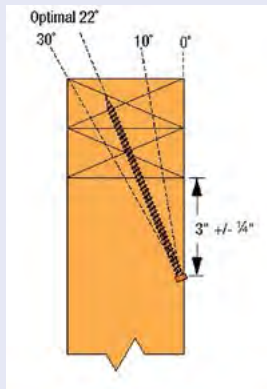
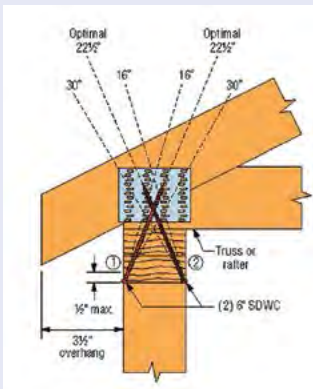

**Figure 4-22.** Orientations of the different connections. (Left) For the double-top plate to the truss, the target angle is  $22.5^\circ$  with a leeway from  $16^\circ$  to  $30^\circ$ . Target entry is the lower corner of the double top plate and stud intersection. (Middle) For the stud to double-top plate, drill angle is  $22^\circ$  with leeway from  $10^\circ$  to  $30^\circ$  and entry point  $3 \pm 0.25$  below the stud to double-top plate intersection. (Right) For the stud to sill plate, drill angle is again  $22^\circ$  with leeway between  $20^\circ$  to  $30^\circ$  and entry point  $2.75$  from the top of the sill plate. Simpson provides a metal guide to hold the SDWC at the desired angles of  $22^\circ$ . It is recommended that the work proceed one level at a time from the top down, starting with the double-top plate to truss connection.



Figure 4-23. This model shows the target orientations and geometry for entry points and drill angle. As mentioned in Figure 4-22, some leeway is allowed. This would be simple for new construction. However, as a retrofit, the complication arises in the presence of the second wall or siding, which hides the structural elements and must be accounted for. Trigonometry will be required to make the adjustments (see next figure). While this is a simple installation, the homeowner should consult with a licensed structural engineer and architect before beginning. In addition, review the demonstration project for the structural screw found at the Hawai'i Homeowner's Handbook website: <http://seagrant.soest.hawaii.edu/homeowners-handbook-to-prepare-for-natural-hazards> and Reference Link 44).

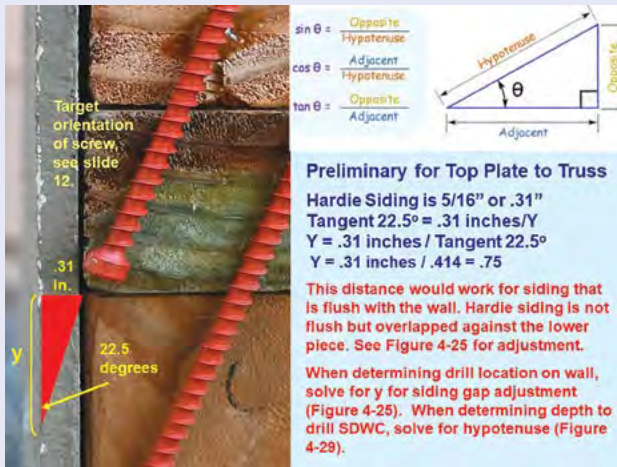
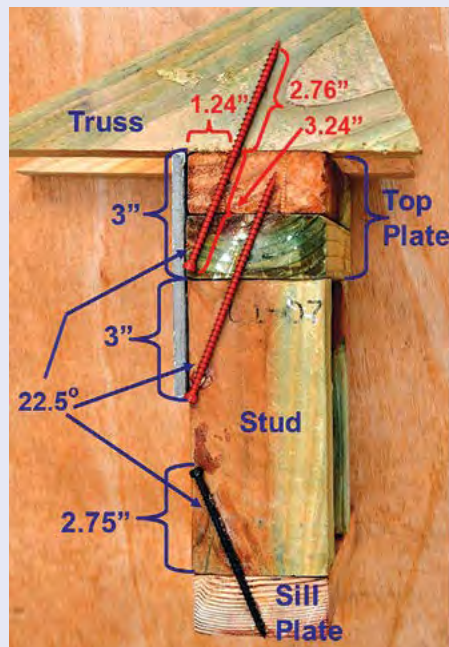

Figure 4-24. This and previous figure show the target orientation of the structural screw for the double-top plate to truss connection. With the siding present, trigonometry is used to calculate where on the wall to begin drilling so that the SDWC has the correct orientation. Here the siding is 0.31" and the drill point should be 0.75" below the stud double-top plate intersection (solve for  $y$ ). Many walls will be flush like this and the key factor is wall thickness. Some houses may have just siding or some siding and plywood. Determine the thickness ( $x$ ) to make the calculation for the flush wall scenario.

Figure 4-25. For many double-wall houses, the siding may not be flush but overlapped, such as for Hardie Siding. Here the thickness of the siding must be accounted for as well as the gap space. The trigonometry is a little more involved, as shown here, to determine a gap and siding adjustment. For this project, the adjustment for the double-top plate to truss connection is 1.1" below the double-top plate stud intersection. Similar calculations and adjustments were made for the double-top plate to stud, and stud to sill plate connections (see Reference Link 44).

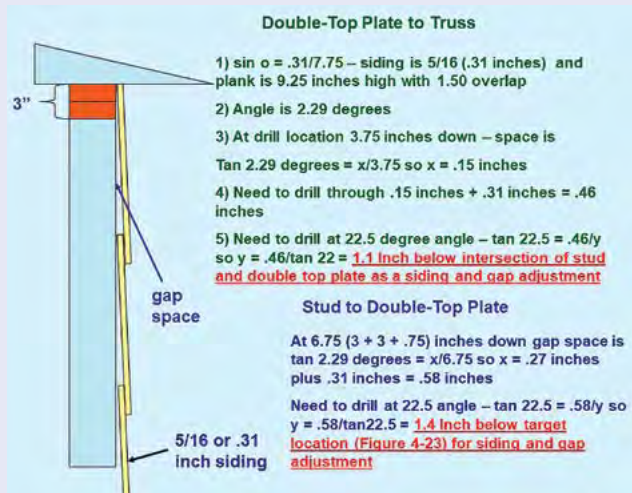

Figure 4-26. Key is to determine the location of the bottom of the double-top plate, the entry point for the double-top plate to truss connection. Go to the intersection of the truss with the wall and cut a small square or rectangle with a multi-tool. The cutout reveals the bottom of the double-top plate for this house is 1.5 inches below the trim. A house wrap (waterproof barrier) is between the double-top plate and siding. Save the cutout and house wrap to later patch and repair.

Figure 4-27. With the location of the bottom of the double-top plate at 1.5" below the trim (see Figure 4-26) and the gap siding adjustment of 1.1" (see Figure 4-25), the drill point for this house for the double-top plate to truss connection is 2.6" below the trim where the truss extends past the wall (red stars). To see how the drill points for the double-top plate stud and stud sill plate connections are determined, see Reference Link 44.





Figure 4-28. For most materials it is easy to drill the SDWC. Simpson provides a metal guide to hold the SDWC at 22°. Hardie Siding however is difficult to drill as the material is made of hard fiber cement. It may be necessary to pre-drill first with a short bit, and second with a longer, wider bit.

Figure 4-29. The SDWC is drilled at a shallow angle of 22° and driven past the siding to the target orientation as shown in Figure 4-24. A 3.5" T30 Star bit (available online) will facilitate drilling deep enough to get past the siding. Etch the drill bit with a rotary tool to mark how far to drive the screw into the siding. This is a trigonometry calculation based on the thickness of the siding and gap, and solving for the hypotenuse (see Figures 4-24 and 4-25).

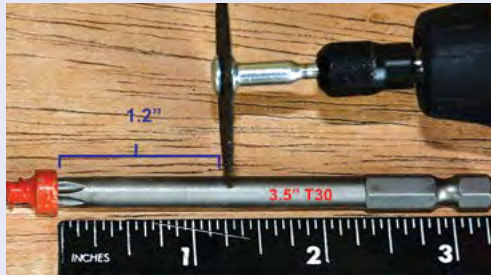
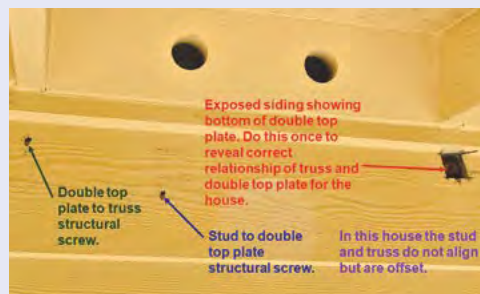

Figure 4-30. Simpson makes the Quik Stik to facilitate drilling the SDWC. It sells for under \$200 and holds the structural screw at the proper drill angle. This tool is useful for new construction and may eliminate the need for pre-drilling in retrofit applications, especially for softer siding. For hard siding, some pre-drilling may still be required. An impact driver is hooked up on one end and the SDWC loaded on the other (see Reference Link 45).

Figure 4-31. Completing all the double-top plate to truss connections is an accomplishment. Now attempt to complete the double-top plate to stud. Here the stud and truss do not align. Find the stud by: (i) using a stud finder (it does work through siding), (ii) drilling very small exploratory holes, or (iii) noticing where the nail is on the Hardie Siding (usually attached to the stud). Studs are typically 16" or 24" apart so after finding the center of one, adjacent ones are readily found. Regarding entry drill depth, see Figure 4-23. Note the entry point is 3" lower than the double top plate to stud connection. Now add the siding and gap adjustment (see Figure 4-25 and Reference Link 44).



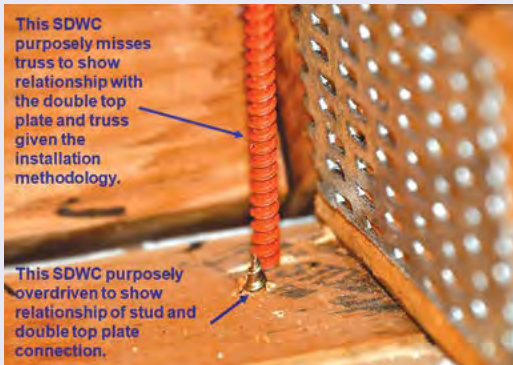

Figure 4-32. To check the work in the attic, purposely missing the truss. Drill a few inches to the side. Before any test drilling, find a suitable truss by going to the attic to make sure the area is free of all cords, wires or connections. Proper installation technique should have the orientations as shown in Figure 4-23. After installing the connectors, patch the hole (e.g., wood putty for wood siding, cement patch for fiber cement siding), sand, and paint.

## 4.2 Concept 2: Creating the Wind- and Rain-Resistant Envelope

During a hurricane, it is very important to protect the envelope of a house from wind and rain. Windows can serve to protect that envelope, unless they shatter, which is almost certain to happen if they are unprotected. **Taping windows will not protect that envelope.** Instead of small little pieces of glass flying around, the taping will create large pieces of glass that are even more dangerous. A broken window during a hurricane can be devastating in several ways: besides the incoming hurricane-force wind and torrential rain in the living room, there is shattered glass and debris from outside flying in. It can make walking around hazardous. Even more importantly, there is the problem with internal pressurization of the house (see Figure 4-33).

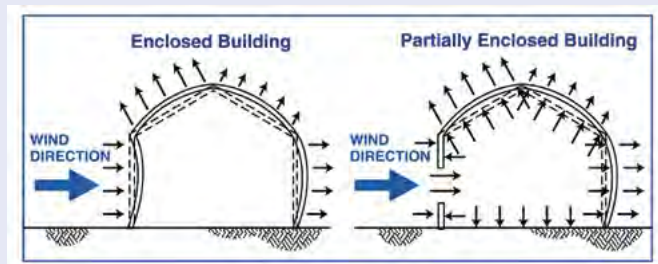

Figure 4-33. This figure illustrates the importance of protecting your windows. The diagram on the left shows a structure with the wind- and rain-resistant envelope intact. Pressure on the walls and roof comes from the outside only. In the diagram on the right, the structure's wind- and rain-resistant envelope has been breached due to a broken window. Now, pressure on the walls and roof comes from the outside and inside. The total amount of pressure increases significantly and can lead to the roof flying off and complete structural failure. Diagram from FEMA's Coastal Construction Manual (2000).

Some reports indicate that a window breach can potentially double the uplift forces on the roof and can significantly increase the chances that the roof will lift off.<sup>26</sup> This is why FEMA indicated in their assessment report that breach of the building envelope and subsequent internal pressurization led to progressive structural failure for many houses.

## 4.3 Window Coverings

Since protecting the wind- and rain-resistant envelope of a house is so important, much information is provided here on window coverings. At this point, it is necessary to go over the various options. The cost estimates provided are based on local estimates for materials only as of 2019. Pricing may vary between vendors and may change over time. Check with the manufacturer that the coverings to be installed are tested and approved to meet industry standards for hurricane impact. Use only licensed contractors and reputable dealers. Make sure the coverings provided have gone through testing and the manufacturer can provide testing certifications under the American Society of Testing and Materials (ASTM) E1886 and E1996 standards. The Missile “D” certification requires resisting a 2 x 4-inch 9.0 lb. piece of wood that is 8 feet long fired at 34 mph (50 ft/sec) at the coverings. Not as strong, but still acceptable is the Missile “C” test - 2 x 4-inch 4.5 lb piece of wood that is 4 feet long fired at 27 mph (40 ft/sec).

### 4.3.1 Roll-down Shutters

Roll-down shutters permanently attach to a building that are housed above the window.

**Figure 4-34. During an emergency, roll-down shutters are quickly lowered as necessary. The shutter is held in place by guide tracks along the sides of the window and secured at the base by a latch on the guide track. For home use, the shutters can be deployed electrically or manually.**



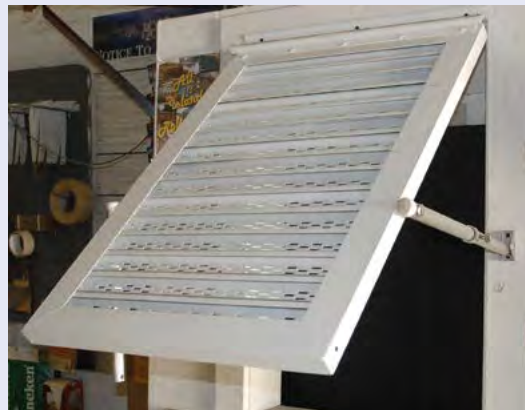

**Figure 4-35.** Roll-down shutters can provide significant protection against hurricane winds. The NOAA National Weather Service facility is protected with these shutters; here, the shutters are fully deployed over the two middle windows, and partially deployed at the sides. The shutters are made from heavy duty aluminum slats.

### 4.3.2 Bahama Shutters

Bahama shutters consist of a one-piece louvered unit that is attached above the window and propped open to provide shade. As with any permanently installed shutter system, permission may be required from the local homeowner's association before installation can proceed.

**Figure 4-36.** As a storm approaches, the Bahama shutter is pushed down against the wall and anchored with stainless steel bolts through the frame into anchor sleeves in the wall. Photo courtesy of Hurricane Secure.



### 4.3.3 Colonial Shutters

For many homes in Hawai‘i, colonial shutters have many of the advantages of Bahama shutters (quick deployment, aluminum panels), while being more esthetically pleasing.



**Figure 4-37.** Colonial shutters are typically made of aluminum or fiberglass. During a storm, the panels are closed and secured along the vertical center of the window. During good weather, the panels open along hinges on the side of the window and rest flat against the wall in a decorative manner. Photo courtesy of Hurricane Secure.

### 4.3.4 Accordion Shutters

Accordion shutters are similar to roll-down shutters, but where roll down shutters are housed along the top of the window, accordion shutters are stored along either side of the window frame (see Figure 4-38).

**Figure 4-38.** For deployment during a storm, the panels unfold accordion-style and extend toward the center of the window along pre-installed tracks. Photo courtesy Hurricane Secure.



### 4.3.5 Storm Panels

Storm panels were originally made of aluminum or steel, but now also come in clear plastic. The panels are corrugated and overlap for extra strength. Although the panels require storage when not in use, they usually stack together so the amount of space required is minimal. The clear plastic panels are an especially attractive option for homeowners in Hawai‘i since they allow light to pass through while providing strong protection from flying debris from a hurricane. They are a good option for the first floor of houses or wherever there is easy access, and the panels are relatively inexpensive at \$12-\$14 per square foot.



**Figure 4-39.** Although installation varies, this example shows panels that slip into a track above the window. The bottoms of the panels are secured by bolts that are permanently attached to the window. Photo courtesy of Hurricane Secure.

**Figure 4-40.** New versions of the hurricane storm panel come in clear plastic which allows light to be transmitted through the window. Some residents leave the panels up during the hurricane season. The tracks are permanently attached to the window and panels attach with wing nuts.





### 4.3.6 Impact-Resistant Glass Systems

Impact resistant glass consists of a laminate film sandwiched between two glass panes. The layers are fused together at high heat and secured with fortified window frames. A company offering impact resistant glass should provide certification that the unit has passed American Society for Testing and Materials (ASTM) standards. Typically, a 9 lb, 2 by 4-inch piece of wood is shot at 34 mph at the unit (window and frame). After the missile tests, the unit is tested for positive and negative pressure cycles that simulate hurricane gusts and changing wind directions to ensure the envelope holds and there is no breach.

Impact resistant glass has many advantages as it is always in place to provide protection from hurricane windborne debris (ASTM E1886/1996 standards) and an impenetrable barrier from robbers (ASTM F1233 and UL972 standards). During a hurricane, the window may still crack, but the envelope of the house will hold to prevent major damage associated with water intrusion and particularly internal pressurization of the house (See Figure 4-33). The disadvantage of these windows is the expense of the initial purchase, and after a hurricane, the window may need replacement. However, while there could be costs associated with replacement, it is a

#### **Impact Resistant Glass can:**

- 1) dampen sound**, which significantly reduces unwanted noise, from traffic to the howling winds of a storm or hurricane. Look for the ASTM Outdoor/Indoor Transmission Class (OITC) rating.
- 2) block harmful UV radiation**, which can fade fabric, furniture, or other materials, but the glass still allows for unaffected plant growth. Look for the Damage Weighted Transmission Measurement (Tdw) for the fading reduction potential.
- 3) reduce solar heat gain in-take**, making houses cooler, reducing energy or air conditioning costs while providing balanced temperatures year round.
- 4) open view planes while maintaining privacy**. The reflective properties of laminated glass create a mirror effect during the day, maintaining privacy even when blinds are open.

very small fraction of the costs if there is breach of the wind and rain resistant envelope during a hurricane.



**Figure 4-41.** This impact-resistant window is installed on a typical double-wall house on O‘ahu. This window has passed the ASTM E 1996 standard, Missile “D” 9.0 lb 2” x 4” at 50 ft/sec or 34 mph. The advantage of this system is that it is always in place to provide year-round protection against hurricane wind-borne debris, or a robber. In addition, there are environmental sustainability and climate adaptation benefits related to reduced sound, protection from damaging UV radiation, reduced heat intake, increased views and privacy (see box). Photo courtesy of Coastal Windows.

### 4.3.7 Laminates

Just as laminates are used to create impact-resistant glass on new windows (see Part 4.3.6, Figure 4-41), they can also be placed over and used to protect existing windows (see Figure 4-42). For laminates, the amount of protection is a function of the thickness of the film, the type of glass being protected (safety glass versus plate glass), the existing frame in which the window is set, and the attachment of the frame to the house structure.

Under the former State of Hawai‘i Loss Mitigation Grant Program, laminates qualified for the grant if details were shown of how the window attached to the frame and walls, and data was provided showing that the assembly met hurricane impact standards. For some insurance companies, laminates may qualify for a discount on their hurricane insurance premium. While laminates may provide more protection than unprotected windows, they are not a substitute for shutters, or even impact resistant glass (Part 4.3.6), which is designed around specially strengthened frames and have undergone extensive testing to meet ASTM standards. Laminate films may provide some of the environmental benefits related to reduction in noise, lower UV transmission, and reduced heat intake.

**Figure 4-42.** Laminated film comes in various thicknesses and strengths. Here the film is applied to an existing window before it is fastened to the frame with silicone structural sealant. Many companies provide laminates on existing windows. Even stronger are laminates on specially designed newer window frames. In some cases, they pass ASTM E1996 standards Missile Level “C” - 4.5 lb. 2” x 4” at 40 ft/sec or 27mph.



### 4.3.8 Hurricane Mesh, Screen, or Fabric

In many cases, it may be difficult to protect some windows because they cover a large area or have an unusual configuration (for example, if they extend out past the wall). In this case, one option would be to use a hurricane screen, mesh, or fabric.



**Figure 4-43.** Hurricane screen, mesh, or fabric consists of woven polypropylene or a resin coated ballistic nylon. The screen can cover large areas and provide protection to windows with unusual configurations. Light can pass through the fabric so that the area inside is not totally dark. Photo courtesy of the Department of Emergency Management, City and County of Honolulu.

**Figure 4-44.** Installing hurricane fabric for the large patio windows. The fabric can deflect wind-borne debris. In addition, if properly placed, the fabric can deflect high winds, thereby minimizing uplift of overhangs. The fabric is lightweight and can be put up quickly and taken down by one person. During normal conditions the fabric is rolled up and stored in a bag for easy storage. Photo courtesy of Hurricane Secure.



### 4.3.9 Plastic Honeycomb Panels

A relatively recent and positive development in providing the consumer with more options for window protection is the introduction of plastic honeycomb panels made of polypropylene and even stronger polycarbonate (see Figure 4-45). These panels are installed like plywood and have many of the good properties of regular plywood, with few of the disadvantages. The panels are white and translucent.

The honeycomb panels also come in a clear plastic version that lets light through. This is an attractive option to other protective systems, which can significantly darken a house when they are in use. However, these panels are more expensive than the opaque version.

**Figure 4-45. Plastic honeycomb panels have many times the strength of regular plywood and will not warp or rot. It is easy to cut and drill into, and, most importantly, it is light when compared to regular plywood. The major disadvantage is the lack of availability of this material in local hardware stores. However, some stores are beginning to bring in the clear polycarbonate material in 4' x 8' sheets.**



### 4.3.10 Plywood Shutters

One of the most important options for window protection is regular plywood. Plywood is available at almost every hardware store and offers good protection, if properly installed. Furthermore, the material cost is the least expensive of any of the other options discussed.

The main disadvantage of plywood is that it can rot or warp if stored in a wet or warm area. In addition, plywood shutters are relatively heavy. It will take two people who can lift 30–40 pounds to help with the preparation and deployment of these shutters. Plan accordingly, as it will not help if the people being counted on for assistance are not available during the deployment. Because of their weight, it would be difficult, or even dangerous, to install plywood shutters if a ladder is needed. Thus, plywood

shutters are good for easily accessible windows on the first floor, or windows that can be easily reached by a terrace or patio on upper floors.

Table 4-2 lists the advantages and disadvantages of each type of window covering. In many cases it may be preferable to mix and match the options. For example, use plywood shutters for easily accessible windows, storm panels, or another type of system for windows with medium accessibility, and roll-down shutters or impact resistant glass for windows that are difficult to reach. This will allow all windows to be covered at reduced costs. For those that have the resources, or are limited physically, impact-resistant glass or roll-down shutters are a good option. For the budget minded, storm panels, hurricane mesh, and plywood are good options. All prices in Table 4-2 are for material costs only, subject to change. The only protection a homeowner can reasonably install themselves is plywood (Part 4.4), so material costs also approximate installation costs for that option.

**Table 4-2. Pros and Cons of Various Types of Window Protection**

Type of Protection	Pros	Cons	Cost for 3 ft x 4 ft window
<b>Impact Resistant Glass</b>	Always in place hurricane and security protection. Blocks noise and harmful UV radiation. Reduce solar heat gain to keep house cool and energy efficient. Opens view planes. Pass large missile tests.	Costs to buy and replace existing windows and frames can be high. While house contents are protected, there is potential for outer layer to crack, requiring replacement.	Wide range in costs - \$800 or more
<b>Roll-down Shutters</b>	Easiest to deploy. Good protection.	Most expensive of permanent shutter systems. Needs manual backup for power outages or an emergency power source. May need homeowner association approval.	\$800
<b>Bahama Shutters</b>	Easily deployed. Good protection. Provides shade.	Esthetics. May need homeowner association approval. Blocks light.	Market Price

Type of Protection	Pros	Cons	Cost for 3 ft x 4 ft window
Colonial Shutters	Easily deployed. Good protection. Esthetically pleasing.	May need homeowner association approval. Requires room along side of window for shutter to swing out.	Market Price
Accordion Shutters	Easily deployed. Good protection.	Esthetics. May need homeowner association approval.	\$350
Plastic Honeycomb	Strong system. Lightweight. Reasonable cost. Won't warp or rot. Availability improving.	Storage of panels. Time to create and deploy. Availability.	\$225
Hurricane Mesh	Covers large areas and windows with unusual configurations. Allows light in. Lightweight.	Need proper supporting locations to fasten geotextile or mesh. Need accessible roofline.	\$225
Laminates	Storm, security, and UV protection. Energy efficient. Always on. Allows light in. Ideal for hard-to-reach windows. May be able to pass small ASTM missile tests with new frames.	Other systems are stronger. Need to lock laminate to frame. Frame must be strong. Window may need replacement after storm. Cost increases significantly for new frames.	\$200
Storm Panels	Strong. Removable. Relatively inexpensive permanent shutter system. Good protection for the costs.	Requires adequate space to store panels.	\$150
Plywood	Materials readily available. Easy to install on lower levels. 5/8" heavy but strong.	1/2" Not as strong as some other shutter systems (for example, roll-downs, or storm panels). Difficult to install on upper levels.	\$30 to \$35

## 4.4 Installing Plywood Shutters

Because financial cost is a barrier to some homeowners obtaining window protection, plywood shutters are a very attractive option. Yet these shutters take time to create and deploy. Some suggestions summarized here could reduce installation time and make this option even more attractive. There is scattered information on installing plywood shutters, and there is more to it than just buying plywood. Some of the tips provided in this section can also apply to the installation of plastic honeycomb panels.

### 4.4.1 Obtaining Assistance

Although plywood shutters can be installed by a handy homeowner to save on cost, it is still a good idea to seek the advice of a licensed architect or structural engineer before starting. Professionals can provide guidance on specific details for windows. The samples provided in this section may pertain to general applications, but remember that each window can be a little different. In addition, this section does not cover difficult applications such as installation for circular or triangular windows. Under the former State of Hawai'i Loss Mitigation Grant Program, grants were possible for window coverings, but drawings for the windows were required by a licensed architect or engineer. Some insurance companies that offer discounts on hurricane insurance premiums for window coverings do not require the drawings.

### 4.4.2 Material to Use

For plywood shutters, it is recommended to use at least  $\frac{5}{8}$  inch plywood.<sup>27</sup> However, if the weight is too much, and the alternative is to do nothing, buy thinner plywood. It is not as strong as  $\frac{5}{8}$  inch plywood and did not perform as well during destructive Hurricane Andrew in Florida in 1992. However, some insurance companies may allow use of thinner  $\frac{1}{2}$  inch plywood to obtain a discount in hurricane insurance premiums. Nominal  $\frac{1}{2}$  inch or  $\frac{7}{16}$  inch is allowed under the Hawai'i State Building Code, which was adopted by the State Building Code Council on November 13, 2018.



Thicker widths could be considered, too, such as  $\frac{3}{4}$  inch, since it is stronger than  $\frac{5}{8}$  inch. The major concern with the thicker plywood is the added weight and difficulty in handling. For most people,  $\frac{5}{8}$  inch exterior-grade plywood is a good compromise between strength and practicality during installation. Since the new Hawai'i State Building Code allows a minimum thickness of  $\frac{7}{16}$  inch plywood for new houses, it is also recommended for existing houses, although  $\frac{5}{8}$  inch is the preference because it is stronger.

Plywood should be treated to prevent termite damage when it is stored. In the past, harmful chemicals were used to treat plywood, but since the mid-1990s, it has been treated with borate, which is user-friendly and requires no special handling precautions. Thus, there is no downside to handling the treated wood currently on the market.

Buying plywood during the hurricane off-season means there will be a plentiful supply, and the stores may even cut the wood for little-to-no extra charge. Once a storm is actually approaching, there will be long lines, limited or no supply, and the possibly of no cutting service. Do not use Oriented Strand Board (OSB) to protect windows. To see the difference in protection between plywood and OSB, see Reference Link 46.

#### 4.4.3 Measuring the Windows and Cutting the Plywood

For a double-wall house, when measuring the window widths, it is important to have a sufficient overlap of 4 inches on each side of each window.

**Figure 4-46.** In general, a plywood shutter should have 4 inches of overlap on each side of the window. Thus, if a window is 46 inches wide, the shutter should be 54" wide. Figure courtesy of Department of Emergency Management, City and County of Honolulu.

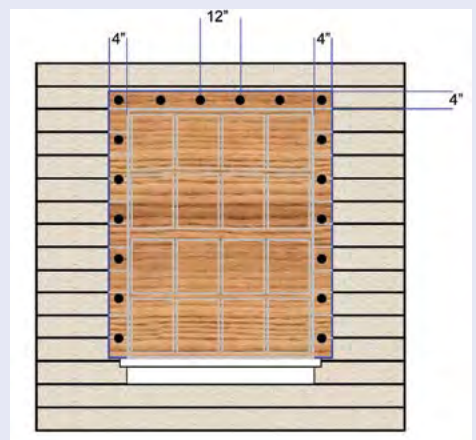



Overlap on the sides of the windows is essential because the fasteners to attach the plywood will be placed: (i) away from the edge of the window, (ii) away from the edge of the plywood, and (iii) directly into the wall studs that surround the window rather than in the siding of the house (see Figure 4-47).



**Figure 4-47.** For this double-wall house under construction, two 2 by 4's frame the window. When attaching the plywood to the window, the fasteners should go into the 2 by 4's, not the siding. It is always useful to know how your house was built. Take pictures during construction (if possible), review your blueprints, drill small test holes if you have to, or ask your architect or home builder for the details on your window.

Plywood comes in 4 by 8-foot sheets (48" by 96"). For larger coverings, say 54 by 54-inch, join together two sheets of plywood. The point where two panels meet is called a joint. These joints should be supported and can be connected by extra 2 x 4's (see Part 4.4.8).

**Figure 4-48.** In this picture of a plastic honeycomb panel installation, the translucent panel reveals the location of the window to be protected (dark area). The panel overlaps the edges of the window by 4" and the fasteners are in the underlying studs around the window that are part of the structure of the building. A plywood installation would be similar (see Reference Link 47).



It may take up to two days to measure the windows, buy the plywood, cut it to the proper dimensions, label the panels, designate where all the fasteners are to be attached and pre-drill. This would be very difficult to do when there is an incoming storm. **These preparations need to be done in advance during good weather, preferably before hurricane season.**

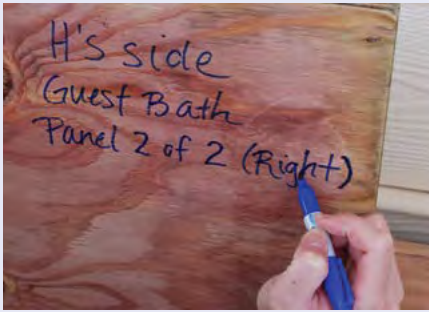

Figure 4-49. After the plywood is cut for each window, each piece should be labeled so that the panels for one window are not mixed with those for another. It would also save time to indicate on the panels, well before any threat of a storm, where the fasteners will be attached.

#### 4.4.4 Fasteners and Attaching the Panels

There are many different ways to attach plywood panels to the window frame. Some literature suggests using nails in an emergency. However, nails would not be as strong as screws and also are very difficult to remove after they are attached. The fasteners shown below are consistent with Hawai'i State Building Code, which was passed by the State Building Code Council on November 13, 2018. Based on the specifications, the following can be utilized for wood-frame houses:

- A) #8 wood screws with 2-inch embedment placed 16 inches apart for panel spans of under 4 feet; 10 inches apart for panels between 4 and 6 feet; and 8 inches apart for panels between 6 and 8 feet; or
- B) #10 wood screws with 2-inch embedment placed 16 inches apart for panel spans of under 4 feet; 12 inches apart for panels between 4 and 6 feet; and 9 inches apart for panels between 6 and 8 feet; or
- C) ¼ inch lag screw with 2-inch embedment placed 16 inches apart for all panel spans up to 8 feet.

Figure 4-50 shows (A) a #8 wood screw, (B) a #10 wood screw, and (C) a ¼ lag screw. The duplex or two-headed nail (D) is also shown for quick attachment of the panel on the top right and top left corners; this is used to hang the panel to the frame before using one of the wood screws. Thus, D would be used with either A, B, or C. Although the screws discussed in A, B, or C are self-driving, it may still facilitate installation to pre-drill the locations on the panel. All should be readily available at hardware or home improvement stores.

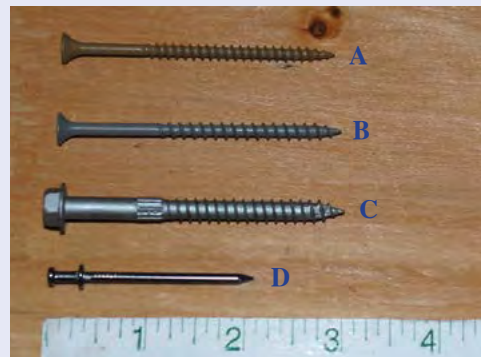

Where screws are attached to masonry or masonry/stucco, they must be attached using vibration-resistant anchors with a minimum withdrawal of 1,500 pounds. The Simpson Strong-Tie self-driving screws are not suitable for masonry, but tap cons or Simpson Strong-Tie Titen screws can be used instead.

#### 4.4.5 Deployment

When preparing for plywood deployment, follow the 4 P's. If the plywood is: (i) pre-cut, (ii) pre-labeled, (iii) pre-marked with the location of all fasteners and (iv) pre-drilled, then deploying and installing the boards can be relatively quick. First, align the panel, and then hammer a duplex nail into each top corner of the panel to hold it onto the frame. With the panel held by the two duplex nails, it becomes easier to drill the screws into the appropriate pre-marked locations for the remainder of the panel. The duplex nails can easily be removed later, as they are designed for easy insertion and removal. The duplex nails are only used to hold the panel in place while the wood screws are drilled into place. They are not sufficient to fasten the panel itself.

It is very important to test the deployment and fasteners well before a storm. This will help to catch and remedy any unforeseen difficulties. For example:

- 1) Do the screws drive in easily without pre-drilling? If not, consider pre-drilling, which is relatively quick. It is possible for one person to pre-drill with a bit and another to drive in the screws.
- 2) Do the screws strip? Obtain high quality wood screws and, if necessary, pre-drill. Buying good screws will reduce the time of installation.
- 3) Does the hand-drill being used have enough torque, or does it run out of power easily? Consider an 18-volt drill instead of a 12- or 14-volt one. Have extra charged batteries and an extra charger. Modern power tools now use lithium ion batteries which last longer, have more power, and are lighter.



Many of these questions can be answered by sales assistants at the hardware or home improvement store.

#### 4.4.6 Other Methods of Installation

It is also possible to permanently attach the fasteners to the frame of the house (see Figure 4-51). This has the advantage that the panels can be more quickly deployed and redeployed without drilling more holes. Attaching the fasteners permanently takes more installation time and many of the materials are not readily available. This method is useful if the panels need to be taken up and down frequently (for example, those in Florida). In Hawai'i, the frequency to deploy would not be as great, and thus the method in Part 4.4.5 is acceptable as long as all the panels are fully ready to go well before a storm.

Permanently installing the fasteners is more complicated, but either a licensed contractor can do it, or a homeowner can with guidance from a licensed architect or engineer. One of the difficulties in permanently installing fasteners is obtaining the materials. Hurricane shutter kits with hanger bolts are available online, or a licensed contractor experienced in this area could provide assistance.

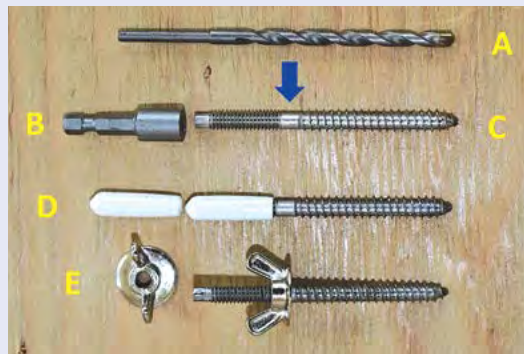

**Figure 4-51.** Many panels have permanent fastenings attached to the house. (i) After attaching the panel to the frame with two duplex nails (A); (ii) holes are drilled with the bit (B) into the panel and wood frame; (iii) then a spade wood boring bit (C) cuts wider holes into the panel and frame; (iv) a lag screw anchor with female receptor (D) is screwed into the wood frame; (v) and the panel is attached with washer and wing nut (E).

## 4.4.7 Simpson Strong-Tie Storm Panel Screws

The Simpson Strong-Tie Storm Panel Screws (“SPS”) are currently available in many hardware stores in Hawai‘i and meet many building code requirements for storm-panel attachment to wood and concrete structures. Once the screws are installed, storm panels can be easily attached or removed. This could work for plywood or polycarbonate panels which are lighter, but more difficult to find. See Figure 4-52 for the simple components of the Storm Panel Screw fastening system.

Figure 4-52. The SPS comes in a box consisting of: (A) drill bit, (B) hex driver, (C) 25 stainless steel screws, (D) 25 plastic caps, and (E) 25 wing nuts. The drill bit is used to pre-drill the hole for the SPS into wood or concrete. The hex head then drives the SPS into the material to the intersection of the coarse and fine threads (blue arrow). The white cap covers the screw during normal conditions. The wing nut is used to fasten the panel during a storm. A box costs about \$50. With 16-inch spacing and a 3 ft x 4 ft window, a box will cover 2-3 windows in a full perimeter install and 12 windows for a partial.



As noted above, the SPS can be used in two different ways.

- 1) A **full perimeter install** has the SPS at 16-inch spacing around the entire window. This method takes the most prep time but the least time to deploy. A possible downside is the cost of the screws and esthetics of having the white plastics caps around the entire window frame.
- 2) A **partial install** uses the SPS just on the top right and left corner of the window frame to hang the panel for an incoming event. When a hurricane threatens, the white caps are pulled off and the previously prepared panel (following the four P’s) is hung and fastened by the wing nuts. One or two screws are then drilled around the perimeter to do a partial deployment. If the event veers away, the panel is easy to take down. If the system does threaten, it is easy to drill in more wood



screws before strong winds approach. This method takes less prep time but more deployment time, but is still fairly quick.

Depending on the method used (full or partial install), panels take about 30 to 60 minutes to prepare and only 5 to 10 minutes to deploy.

**Preparation should be done before hurricane season, or well before any threatening conditions. Waiting until there is a threatening storm almost guarantees the stores run out of plywood or SPS screws or the homeowner runs out of time.**

The following installation is suitable for plywood panels, as well as for other materials such as polypropylene (plastic honeycomb panels - Section 4.3.9). Follow the two-step process below for the **full perimeter install** method.

**STEP 1.** Prepare the plywood shutters (Part 4.4). Follow the 4 P's: (i) **pre-cut** the panels to the proper dimensions, generally with four inches of overlap on either side of the window so that the fasteners penetrate the structural framing, (ii) **pre-label** the panel as to what window on the house it is for, (iii) **pre-mark** the location of all fastener holes (Section 4.4.4); and (iv) **pre-drill** the fastener holes with a  $\frac{1}{8}$  inch bit. This makes drilling of the fastening screws easier. It will also allow the option of using #8, #10, or  $\frac{1}{4}$  inch self-driving screws (see Figure 4-50); or the  $\frac{1}{4}$  inch SPS (see Figure 4-52). Follow the suggested spacing in Section 4.4.4 and note that the SPS should be treated as a  $\frac{1}{4}$  inch self-driving wood screw with 16-inch spacing.

**STEP 2.** If the Storm Panel Screws are used around the entire perimeter of the panel, follow these steps:

- 1) In the location where the pre-drilled fastener holes are located, drill a wider hole with a  $\frac{3}{8}$  inch spade bit into the panel (see Figure 4-51 C) for what a spade bit looks like).
- 2) Mount the panel on the window with the duplex or double-headed nails (see Figure 4-50 D), one on the upper right corner and one on the upper left corner. Pre-drilling of the duplex nail locations on the panel may facilitate installation.

- 3) With the panel now mounted on the window, drill the ¼ inch Storm Panel Screws into the center of the pre-drilled ⅜ inch hole and into the structural framing. Drive the screw about 2 inches into the framing so that the intersection of the course thread and the fine thread is flush against the window (see Figure 4-52). Repeat for all fastener locations being careful to center the screw in the hole created by the ⅜ inch spade bit.
- 4) Pull off the duplex nails from the top corners of the panel and remove the panel.
- 5) Adjust screw penetrations so that the spacer between the top set of screw threads and the bottom set of screw threads is at the surface of the framing of the window (blue arrow in Figure 4-52).
- 6) Test installation by placing the panel back on the attached screws and fastening with the supplied wing nuts.
- 7) If suitable, pull off the panel and store for an emergency event. Place the wing nuts in a plastic bag and attach to the stored panel. Place the supplied plastic white caps over the permanently installed screws on the window framing.

For the **partial install method**, follow the above Step 1. For Step 2, only drill the ⅜ inch hole with the spade bit for the upper left and right corner of the panel. Only install the SPS for the upper left and right corner. For deployment during the storm, once the panels are hung, use regular wood screws such as seen in Figure 4-50 to complete a partial or full deployment. Spacing should follow guidance in Part 4.4.4. This method has been used successfully for partial deployments during the record hurricane season of 2015 and during Hurricane Lane in 2018.

Note: The SPS can also be used with plastic panels (see Part 4.3.9). For a full perimeter install, use the SPS with 16 inch spacing. For a partial install, use screws such as the Simpson SDWH 3 inch or the SD9 - 2.5 inch with washers.



## 4.4.8 Larger Windows

Occasionally, more than one sheet of plywood may be needed to cover a larger window or surface, like a sliding glass door. Other times, there may be two scraps of plywood that can be used to cover one window. Joining the two sheets together lends extra support to the protective boards. Certain hurricane insurance companies allow unsupported joints if they are less than 4 feet in length. Supporting all joints is stronger and can be done with a 2 inch by 4 inch board. In no case should panels be joined if it results in a span of greater than 8 feet. The fastening specifications provided in the Hawai'i State Building Code apply to spans up to a maximum of 8 feet. For more information on hurricane shutter design using plywood, please refer to Hurricane Shutter Design Publications with the Engineered Wood Association, formerly the American Plywood Association (APA).



**Figure 4-53.** If the joint between the plywood is short, for example, 4' to 5' in length, a 2 by 4 (really 1 ½" by 3 ½") can be used with the **wide end on the outside against the plywood**. Both ends of the 2 by 4 are then attached with screws through the plywood and into the window frame. This will require two 4 or 4 ½" lag screws, which may require pre-drilling or similar Simpson Strong-Tie self driving screws (SDS).

**Figure 4-54.** For larger windows, such as this sliding glass door, two 2 by 4's face outside and are oriented with the **narrow end against the plywood**. The fastening screws attach from the plywood into the 2 by 4 (see Figure 4-55).







**Figure 4-55.** During assembly of the shutters in Figure 4-34, the two panels to be joined sit atop the 2 by 4's. The outline of the 2 by 4's and all screw locations are marked on the panel. Panels should be cut, labeled, and marked as to all fastening locations before hurricane season. The panels can be quickly attached with wood screws drilled from the plywood panel into the 2 by 4. The panel is then raised with the end near the window being the pivot point. The panel is then attached to the structural framing of the window as shown in Figure 4-54.

The methods discussed in this handbook are not the only ways to attach panels. The larger the window, the more plywood will flex under hurricane conditions. Thus, it is good to leave a 4-inch space between the plywood and the window. If there is not enough space, the window may crack, although the plywood would stay in place and continue to serve as a wind and rain resistant envelope. One way to get around this is to build 2 by 4-inch trim around the window frame and add stiffeners. This may take considerable time and very few window protection installers or homeowners do this.

If there is a hurricane strong enough to flex the plywood panel, then replacing windows after a hurricane would be a relatively minor task if that is all the damage that is incurred. Note that during a hurricane, impact-resistant glass and laminated glass would be expected to break, even though the building envelope would stay intact, if the glass attachment to the frame and the frame are strong enough. Thus, these systems offer protection to the building envelope, although some glass may need replacement after a hurricane (see Table 4-2).

Finally, whenever sliding glass doors or other entry areas are protected, it is necessary to make sure that there are always two storm-protected doors that will be operable for access and exiting at any time.

## 4.4.9 Storing Plywood Panels

Storage space may be one concern you have about using deployable plywood or plastic honeycomb panels. It is possible to store the panels in your garage if they are organized neatly and stacked together (see Figure 4-56).



**Figure 4-56.** Once the panels are created, they can be stored in the garage and take up minimal space if stacked neatly along the side of the garage, with the smallest pieces closest to the wall. Panels should be checked each year for any warping or rotting and replaced as needed.

## 4.4.10 Timing Deployment with a Hurricane Watch or Warning

Consider getting the panels ready even before a hurricane watch. There is a fine line between installing all the panels and fasteners too early only to have the hurricane veer away, and installing them too late when the wind makes it impossible to deploy. If there is a serious threat of a hurricane but no watch or warning yet, do any minor assembly such as joining two panels (as in Figures 4-54 and 4-55) in advance. Then panels can be quickly mounted to the window if the threat increases.

If there is a hurricane watch, do the most difficult installations first. Begin deploying the panels, but not all the fasteners. For example, if using a #10 screw on a 7-foot panel, the fasteners should be 9 inches apart (see Part 4.4.4). Perhaps attach the four corners and the screws 27 inches apart. Leave one or two windows needed for access or light uncovered but ready to be protected. If the probability of a strike decreases and the hurricane turns away, there will be two-thirds fewer screws to remove and holes to patch with wood putty. If the probability of a strike increases, cover the remaining windows and add the remaining screws so that they are all spaced 9 inches apart.

For a partial deployment use either duplex nails (see Figure 4-50) or preferably Storm Panel Screws (see Figure 4-52). Time the deployment with products from the National Weather Service Forecast Office. Two products that are particularly useful are the expected arrival time and the earliest arrival time of tropical storm winds. Plan a partial deployment well before tropical storm winds arrive as it will become very difficult to carry panels once winds get near 39 mph. **The goal would be that when a hurricane warning is announced, complete full installation in one to two hours simply by installing one or two more window panels and drilling the remaining screws. This is possible if all the panels are hung already in a partial deployment. It is important to note that all fasteners need to be installed for the shutter to provide the full level of protection during a hurricane.**

This is a general guideline and will vary for each household depending on the situation. For example, much more time is needed to protect fifteen windows than with five. Another consideration is how much help there will be for deployment and the number of other tasks necessary to prepare the house and family. If there are many windows to protect, or little help for deployment, consider beginning a day or two before a hurricane watch. In some cases, there may be homeowners that deploy their panels, and still plan to evacuate to a stronger structure. In this case, time must be allotted to complete deployment and evacuate to the planned location. **Planning is key and it is better to have too much time than too little.**

## 4.5 Other Wind-Resistive Device Retrofits

Under the former State of Hawai‘i Loss Mitigation Grant Program, grants that covered 35 percent of the cost for properly installed wind resistive devices were provided for up to \$2,100. The program ended on June 30, 2008 with approximately 430 homes retrofitted. The Legislature reconsidered this program in 2019 and it will be further evaluated in the future. The program may be modeled after grant programs on the mainland.

Figure 4-57 displays the various types of protection that were covered under this program. Options to strengthen the house include: (i) roof-to-wall connections (for example, hurricane clips – covered in Parts 4.1,



4.1.1 on the Hawai‘i Plantation Tie and 4.1.3 on the structural screws), (ii) roof protection (Part 4.6), (iii) garage door and window coverings (Parts 4.3, 4.4, and 4.8), (iv) foundation upgrades (Part 4.1.2), and (v) a safe room (Part 4.9). Homeowners should consider these retrofits regardless of whether a grant is available or not, since a house is probably their major investment and provides protection for all inhabitants.

It should be noted that the former grant program required roof-to-wall connections to be in place before any other retrofits. This is in recognition that the roof-to-wall connection is the most critical component for strengthening and completing the continuous load path connection. Once the “weakest link” is taken care of with hurricane clips, the other items can be addressed. **Note: for any house without clips (Table 4-1), this should be the first priority.**

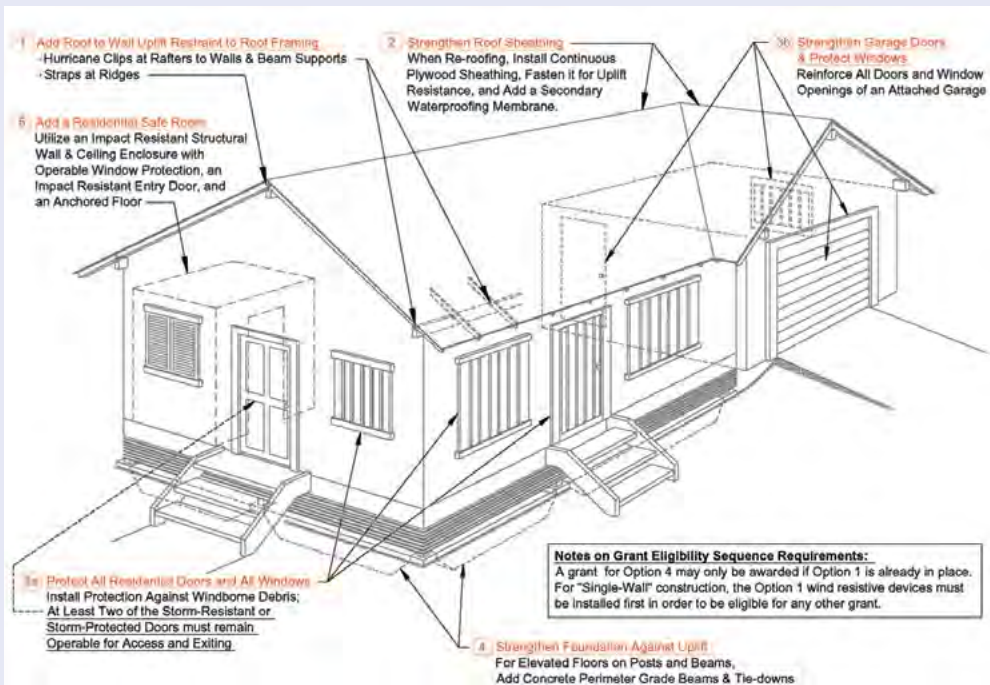

## **OVERVIEW OF THE FIVE OPTIONS OF WIND RESISTIVE DEVICES ELIGIBLE FOR THE STATE LOSS MITIGATION GRANT PROGRAM**

Figure 4-57. Options to strengthen a house under the former State of Hawai‘i Loss Mitigation Grant Program (Figure from the Hawai‘i Department of Commerce and Consumer Affairs – “Wind Resistive Devices Technical Specifications”).

What follows now is a review of some of the more beneficial and protective retrofit options not yet covered in Part 4 of this book. The reader is also referred to the following documents, which can be found by web searches for additional information: 1) Department of Commerce and Consumer Affairs Publication – “Guide to Hurricane Strengthening of Hawai‘i Single Family Residences” and 2) publications from the FEMA Building Science Branch including the “Coastal Construction Manual” (FEMA P-55), “Wind Retrofit Guide for Residential Buildings” (FEMA P-804), and Homebuilder’s Guide to Coastal Construction (P-499). As with all retrofit projects, seek the advice of a licensed architect or structural engineer before beginning. Then decisions can be made about what work the homeowner can do themselves versus hiring a licensed contractor for the more difficult tasks.

## 4.6 Roofing

The wind from a hurricane attacks any weaknesses in the roof. Once a weakness is exposed, adjacent areas can be more easily damaged and peeled away leading to major damage. Thus, strengthening the roof is important, and it should be considered: (i) for new construction, (ii) when a roof is replaced after its expected life, or (iii) even for existing roofs in good condition. Certain measures can be taken in all these situations to make the roof stronger. Improvements can also be made to keep the roof and house cooler, thus providing environmental and climate change adaptation benefits. The roof demonstration project below pertains primarily to asphalt shingle roofs, but suggestions for other roof types are included in the referenced documents in Part 4.5, above.

The key failure points for an asphalt shingle roof are: (i) asphalt shingles peel off roof sheathing (typically  $\frac{5}{8}$ " plywood); (ii) plywood sheathing lifts off trusses or rafters; and (iii) the entire roof is lifted off the walls. The retrofit measures in Parts 4.1, 4.1.1 and 4.1.3 that tie the roof to the wall cover the problem of roofs lifting off the walls, which was a major problem for houses on Kaua‘i during Hurricane Iniki. Refer to Table 4-1, to determine whether these retrofits are necessary, which depends on the island where the house is located and the year the house was built.

For the problem with shingles lifting off the plywood sheathing or sheathing lifting off the truss or rafters, the best time to address this is during new construction or when a house is reroofed. Reroofing provides an opportunity

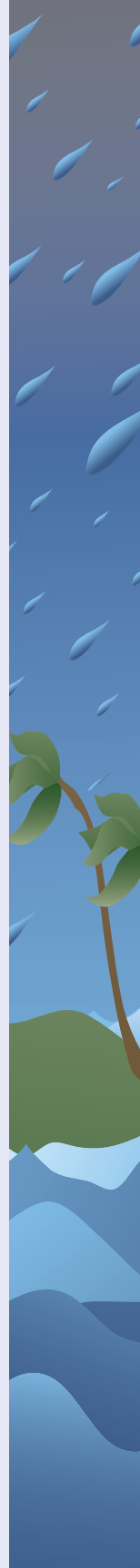

to strengthen one of the most important parts of the house. Many people who install solar photovoltaic panels reroof their house beforehand so reroofing is not necessary after the panels are installed. This is because the average life of a new solar unit maybe 25-40 years or longer, while asphalt shingle roofs typically last 20-30 years and could be approaching the end of their expected life.

We first begin by noting that roofing practices in Hawai‘i have improved over previous standards. By following these common practices in Hawai‘i, a roof is likely to be significantly stronger than similar roofs built 20 years ago.

- Bids should be obtained from three licensed roofing contractors.
- Shingles should be selected with an H rating and a minimum fastener pull-through resistance of 30 lbs at 73 degrees F (see page 2 of Fact Sheet 7.3 in FEMA’s Home Builder’s Guide to Coastal Construction (P-499). Obtaining fastener pull through resistance may require checking with the manufacturer.<sup>28</sup>
- Shingles should be attached by six nails each, as well as having starter shingles along the eaves of the roof. These are requirements for a 130-mph warranty, which is common for roofs in Hawai‘i now. Previously, it was common to use four nails per shingle. Today, many contractors put in six nails per shingle, even if the 130-mph warranty is not sought, and this should be the standard practice.

However, even with these practices, roof damage can occur during a hurricane (see Figure 4-58 for roof components nomenclature and areas susceptible to wind damage).

**Figure 4-58.** During a hurricane, uplift wind pressure on the roof may be 2.8 times greater at the corners compared to the interior areas (shown in white). In addition, increased pressure is along the eaves (edge of roof parallel to the ground) and rakes (edge of roof running up to the ridge). The ridge is the intersection at the top of the roof of the two sloping surfaces and also has increased pressure. Examination of past hurricane damage indicates that blow off of asphalt shingles along the corners, eaves, and rakes is common, even when six nails are used. Adapted from ASCE 7-5, ASCE 7-10 and the FEMA Coastal Construction Manual.

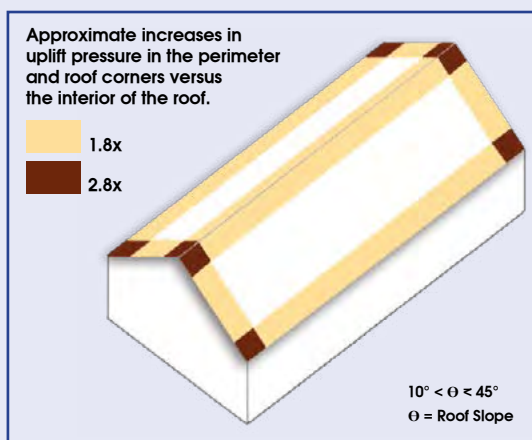



**Figure 4-59.** When Tropical Storm Iselle hit Hawai‘i County, this coastal house experienced wave inundation and roof damage. Although not an asphalt shingle roof, the damage was initiated at the corners, as expected, where uplift pressures were greatest (see Figure 4-58) even though the winds were less than hurricane strength. Better building practices could include fewer overhangs, overlap of roofing panels, and the use of ring shank nails.

**Figure 4-60.** At less than hurricane strength winds, Iselle initiated the peeling off of asphalt shingles along the rakes (edge) of this roof, as expected (see Figure 4-58). This problem would have been much worse with a hurricane, as forces on building structures do not double with the doubling of wind speed but quadruple. Progressive failure with wind speed increase could include peeling off all the shingles, then the sheathing and then the entire roof.



It is possible to build stronger than the common practice currently in Hawai‘i. The following guidelines for asphalt shingle roofs come from many documents including the ones referenced in Part 4.5, FEMA’s Harvey Mitigation Assessment Team Report (P-2022), and the Home Builder’s Guide to Coastal Construction (P-499), which contain Technical Fact Sheet No.’s 7.1 for Roof Sheathing, 7.2 for Underlayments, 7.3 for Asphalt Shingle Roofs, and 7.5 for Roof Vents. Other excellent documents on roofing are with the Insurance Institute for Business and Home Safety under their Fortified Program and the Florida Disaster Organization.<sup>29</sup> These documents also cover tile and metal roofs.

The suggested procedures described below are not commonly followed for residential roofs in Hawai‘i, and they will add about 10-15 percent to the cost of reroofing. Still, if a strong roof is considered the most

important part of a house, then the extra fasteners and adhesives could be well worth the cost in extra protection and peace of mind. Since this is an unusual installation for Hawai‘i, the roofer may not have much experience performing all the tasks, and this could also increase the cost of a bid. Always work with licensed roofing contractors.

The additional installations are as follows. After the roof deck is cleared and cleaned of the old asphalt shingles, the roof sheathing (generally  $\frac{5}{8}$ " plywood) is inspected for integrity. Any damaged sheathing should be replaced. Ring shank nails can be added to fortify the plywood sheathing to truss/rafter connection following FEMA Technical Fact Sheet 7.1 for Roof Sheathing and the Department of Commerce and Consumer Affairs Publication “Guide to Hurricane Strengthening of Hawai‘i Single Family Residences.” An even stronger alternative is to use wood deck screws. The ring shank nails or roof deck screws can only be added during a reroof, when the old asphalt shingles are removed, but it is also possible to fortify the connection from sheathing to truss independent of reroofing, by going into the attic and applying a subfloor adhesive (see Figure 4-61 and refer to Florida Disaster Website on Shingle Roofs and “What you can do if you don’t reroof”).<sup>29</sup>

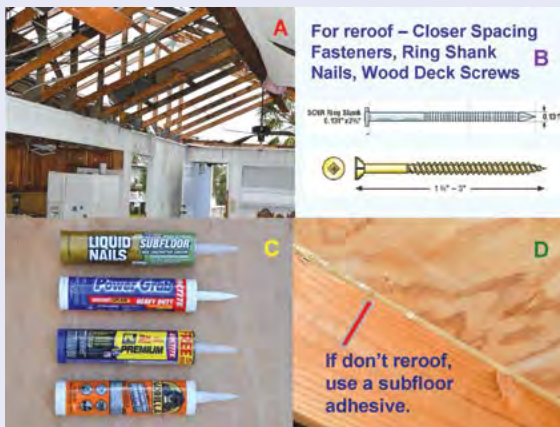

**Figure 4-61.** (A) Wind damage in Rockport Texas from Hurricane Harvey in 2017. The roof deck has been lifted off the truss/rafters leading to major damage. (B) When reroofing, it is possible to fortify this connection with 8d ring shank nails spaced 6" on center (top) or even stronger wood deck screws such as the Simpson DSV wood screw (bottom). (C) Even without reroofing, a subfloor adhesive can be used. Those shown are found at the hardware store and meet AFG 01 standards, recommended in the industry. (D) A  $\frac{1}{4}$ " bead is applied at the intersection of the plywood sheathing deck and the truss on both sides of the truss.



The best time to fortify the plywood sheathing to truss/rafter connection is during reroofing. The Insurance Institute for Business and Home Safety (IBHS) estimates that to add ring shank nails to a typical 2,000 square foot roof is no more than a few hundred dollars. However, if reroofing is unlikely to take place in the near future, existing older roofs can still be strengthened with spray polyurethane foam, which requires a professional contractor. Alternatively, use the subfloor adhesives in Figure 4-61, but this can be time consuming and a semi-difficult installation for a homeowner.

The next step in this asphalt shingle installation, if the plywood is in good condition, is a self-adhering modified bitumen layer complying with ASTM D 1970. It should be applied according to FEMA Technical Fact Sheet 7.2 (see Figure 4-62). If the sheathing is Oriented Strand Board (OSB) instead of plywood, check with the OSB manufacturer to determine if a primer is needed before installing the self-adhering bitumen layer.

**Figure 4-62. A self-adhering, modified bitumen layer (black) is put over the roof sheathing (5/8" plywood for this house). This layer, as the name implies, adheres and seals around holes and cracks in the roof (e.g., joints or the intersection of two sheets of plywood which are potential leak points, as well as around nails that attach the shingles, or around screws that mount PV panels to the roof rafters. If the shingles were to blow off, the layer helps maintain the waterproof barrier. When attaching this layer, the sheet should be sealed around existing roof penetrations such as plumbing vents with roof tape or asphalt roof cement.**



Above the self-adhering modified bitumen layer is placed roofing felt, either ASTM D226 Type II (#30), or ASTM D226 Type I (#15), or ASTM D4869 Type II felt, according to FEMA Technical Fact Sheet 7.2 (see Figure 4-63).



**Figure 4-63.** Roofing felt (grey) is then tacked onto the self-adhering modified bitumen layer. The FEMA guideline calls for the #15 felt, which is supposedly cheaper. In this instance, the #30 felt is stronger and about the same price (considering more expensive materials, but cheaper installation cost). Check with a licensed contractor. The purpose of the felt is to prevent the bonding of the overlying asphalt shingles with the underlying bitumen layer. If there is bonding, it would be difficult to remove the shingles at the end of their useful life. Bonding problems in the past have required complete removal of the plywood to remove the asphalt shingles.

With the bitumen layer and roofing felt in place, starter shingles are placed along the eaves following FEMA Technical Fact Sheet 7.3. The shingles should not overhang the eave or rakes by more than a ¼". Between the starter shingles and first course of shingles are placed one inch dabs of asphalt roof cement (see Figure 4-64). The dabs should be as close to the edge of the roof as possible, just far enough so that the cement does not ooze out.

**Figure 4-64.** To address the increased wind pressure on the corners and edges of the roof from hurricane winds (see Figures 4-58 to 4-60), one inch dabs of asphalt roof cement are placed between the starter shingles (black) and first course of roof shingles (brown) for the eaves. With this technique, the especially vulnerable corners and edges of the house are protected with shingles that are attached with six nails and nine dabs of asphalt roof cement. For exact placement of the shingles and cement for the eaves, rakes, hips, or ridges of the roof, see Technical Fact Sheet 7.3. This method takes time, but is stronger at the vulnerable parts of the house (see Figures 4-58 to 4-60).



The above additions are for asphalt shingle roofs. For other types of roofs, refer to the documents listed in Part 4.5. Any time there is a chance, or need to reroof, this is an opportunity to make the roof significantly stronger with possibly marginal cost and effort. Finally, these additions can also make the roof cooler, which has environmental and climate adaptation

benefits. For example, look for an asphalt shingle with an H Class wind rating, Miami-Dade Product Control Approval, Energy Star Certification, and a rating by the Cool Roof Rating Council.

Since an initial demonstration by West Oahu Roofing ([westoahuroofing.com](http://westoahuroofing.com)) using these procedures, many other houses on O‘ahu have been retrofitted in a similar manner.

**Keep the roof cool to lower energy and air conditioning costs, while increasing the life expectancy of roof components. Cool roofs can also reduce peak energy demand and combat the urban heat island effect by lowering local temperature. Look for these factors:**

**Solar Reflectivity (TSR)**, measured from 0 to 1, indicates the amount of the solar spectrum that the roof reflects. Higher values indicate more energy is reflected.

**Thermal Emittance (TE)**, measured from 0 to 1, is the amount of heat released to the atmosphere, instead of being absorbed in the building. Higher values means more heat is lost to the atmosphere.

**Solar Reflectance Index (SRI)**, calculated from (TSR) and (TE), indicates how well the roof discards solar heat. The higher the SRI, the cooler the roof.

### 4.6.1 Ridge Vents

Another important way to tackle roof heat is using ridge vents. This passive method of attic circulation can be very effective in removing heat from the attic through natural circulation and breezes. The hot air in an attic simply rises to the highest point and escapes through linear vents that are cut along the roof ridge (see Figure 4-65). A cooler attic results in a cooler house, with less energy needed for active cooling. A cooler attic and roof (also related to the reflectivity of the shingles utilized) puts less wear on the shingles and thus helps to extend their lifetime. Ridge vents also last longer than solar fans, which remove hot air from the attic with solar powered fans, but have an expected life of about ten years.

However, ridge vents could conceivably leak and could blow off if care is not taken during installation. If ridge vents are desired and are to be installed as part of reroofing, then a portion of the roof sheathing will need to be cut and removed in order to allow air to flow out of the attic.

The current common practice in Hawai'i has several safe guards. First, in installing the vent, cuts are made into the plywood along almost the entire ridge of the roof. Care is taken not to cut into the truss but only remove the plywood sheathing. Thus the cuts should be no more than the thickness of the plywood, typically  $\frac{3}{8}$ -inch. Second, check that the ridge vents installed are approved by Miami-Dade County in Florida where the design wind speeds are significantly higher than in Hawai'i, and thus certain wind testing has taken place.

Similar to the guidance for asphalt shingle roofs, there are ways to make ridge vents stronger. The following guidelines are from Chapter 11 of the FEMA Coastal Construction Manual. If a ridge board occurs under the roof, and if the sheathing on either side of the ridge is nailed into the ridge board, then in lieu of cutting a slot on either side of the ridge line, it is preferable to cut holes through the sheathing in order to maintain structural integrity of the roof diaphragm. This guideline is not commonly found in Hawai'i. Furthermore, it is more time consuming and thus more costly. While the typical time to cut a linear slot along either side of the roof ridge takes maybe 15 minutes, it took three hours for contractors to cut the holes between the rafters as recommended in the FEMA Coastal Construction Manual (see Figure 4-65). The trade-off in time and cost, however, is a stronger roof.

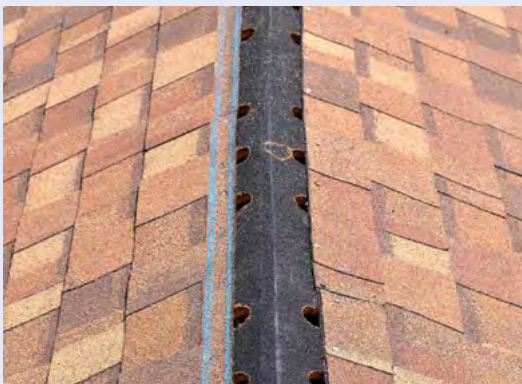

**Figure 4-65.** Instead of a continuous cut on either side of the ridge line, 2 inch holes are spaced 6 inches apart on either side of the roof truss. As a result, the majority of the structural strength in the plywood sheathing leading up to the ridge line remains intact. Refer to Chapter 11 of the FEMA Coastal Construction Manual for the correct spacing. The cut holes should be made with a hole cutter that creates plugs, rather than a grinder that would make wood chips that fall into the attic.

Once the ridge vent is attached, it is possible to make that connection stronger, too, by adding extra fasteners (see Figure 4-66). This is important because if the ridge vent blows off, water can enter the attic and leak inside the house.

**Figure 4-66. The installation of the vent over the roof ridge is made stronger than manufacturer's specifications by doubling the nailing pattern. Ring shank nails are placed in the specified holes and also in between. Asphalt roof cement and nails are then used to attach shingles over the ridge vent. The original specifications for the ridge vent, while strong, were fortified even more since this is a critical part of the roof that is vulnerable to leaks if the vent were to blow off.**



Look for ridge vents approved by Miami-Dade County in Florida, which has the toughest standards for hurricane protection since that is where the devastating Hurricane Andrew made landfall in 1992. Also, look for Florida Testing Application Standards TAS-No. 100(A), which tests ridge vents for wind and wind driven rain, which led to significant flooding problems for houses in Rockport, Texas, when Hurricane Harvey made landfall in 2017.

## 4.6.2 Truss Bracing

It is possible to significantly strengthen a roof by providing lateral and diagonal bracing to the trusses. This is particularly important for houses with gable end roofs which take a beating during a hurricane. This bracing can be done simply with 2 by 4-inch boards, or it is also possible to buy prefabricated metal braces at a home improvement store.

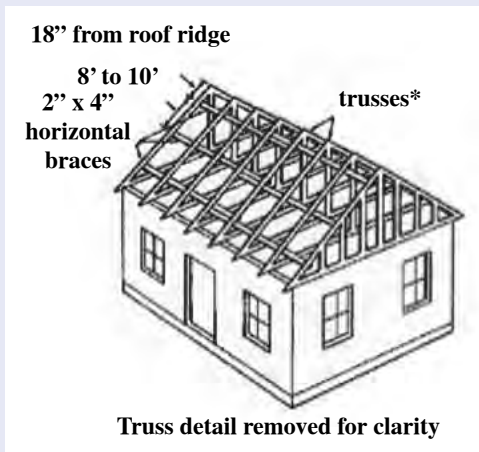

**Figure 4-67.** The trusses are built with a peak at the ridge line of the house. The trusses at the end of the house form an A-shaped pattern known as a gable end. During a hurricane, the gable end is subject to great forces from the wind and is likely to tip over, collapsing the other trusses in a domino fashion.

For lateral bracing, 2 by 4-inch boards are attached to the trusses that run the length of the roof. The 2 by-4 inch pieces should be placed to overlap across two trusses. Braces should be 18 inches from the center ridge and the base, and about 8 - 10 feet apart from each other. Either a licensed professional can do this installation work or the homeowner can, using two 3-inch, 14-gauge wood screws or two 16d (16 penny nails) for each truss.<sup>30</sup>

**Figure 4-68.** In this application of lateral bracing, the 2 by 4's are 18 inches from the ridge and connect to horizontal members that attach the opposing trusses. Not all roofs will have the horizontal members. The 2 by 4's are connected with two #14 3-inch screws (A) and overlap over two trusses (A and B). The end is connected to the gable end with an angle or L bracket (C).



Another important type of bracing for gable ends involves making diagonal braces (see Figure 4-69), which provide additional support against collapse of the gable end. (See FEMA's *Protect Your Property from High Winds* (2011).<sup>31</sup> See also Figure 4-70 for other methods of gable end bracing.

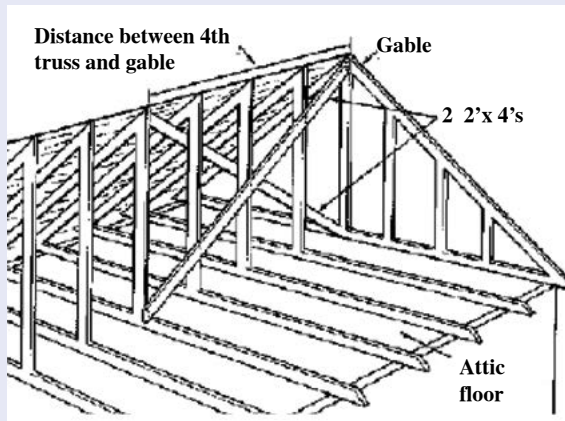

**Figure 4-69.** Diagonal braces form an X pattern from the top center of the gable end to the bottom center of the fourth truss and from the bottom center of the gable end to the top center of the fourth truss. The same screws as for lateral bracing are used.

**Figure 4-70.** In certain instances, large lumber is not practical to install in the attic. Additional designs for gable end bracing under such circumstances can be found in the Home Builder's Guide to Coastal Construction (FEMA P-762, 2009) (Fact Sheet 9.2). See Reference Link 48 for an IBHS video providing a step-by-step guide on installing gable end bracing.

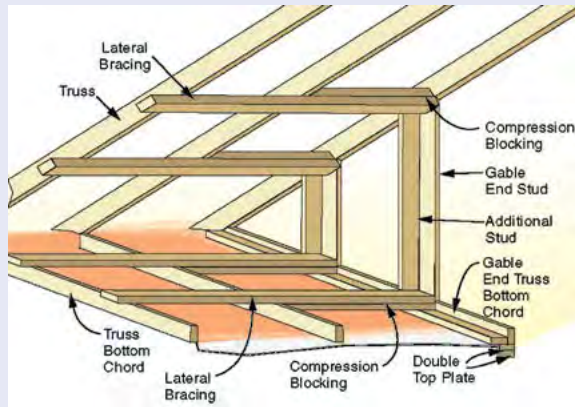

While gable end roofs have a flat end that is A-shaped, hip-style roofs have all four sides of the roof sloping towards the center of the roof. Hip-style roofs do not need as much bracing, as they are aerodynamically superior and they have the bracing built into the design of the structure.

## 4.7 Solar Photovoltaic

The number of rooftop solar installations has continued to grow in Hawai‘i. With these installations, many homeowners are reroofing beforehand, with the potential to make roofs stronger under current practices, and even stronger as covered in Part 4.6. It is important to make the roof as strong as possible so that its expected life is equal to or greater than that of a PV system. This is to avoid having to remove the PV system to replace a roof that has reached the end of its service life, before the end of the PV system’s service life.

There are many measures that can be used to ensure the solar photovoltaic systems remain secure under high wind events. Some important references are: Guide to the Wind Design Provisions of the Hawaii State Building Code, 2010 by Gary Chock prepared for the Hawai‘i Coastal Zone Management Program; ASCE 7-16 Wind Loads for Rooftop Solar; and Rooftop Solar Panel Attachment: Design, Installation and Maintenance 2018 FEMA Recovery Advisory 5, after Hurricanes Irma and Maria in the U.S. Virgin Islands.

- 1) As illustrated in Figures 4-58 to 4-60, the wind pressure is greatest along the corners and edges of the house during a hurricane. Thus, if there is space, keep at least a 3-foot minimum buffer, and preferably a 6-foot buffer between the solar panels and the edge (eaves and rakes) and ridge of the roof.<sup>32</sup>
- 2) When reroofing, make it strong. This is especially important for the ridges, eaves, and rakes. Here the benefits of the additional asphalt roof cement come into play (see Figure 4-64). In addition, the self-adhering modified bitumen layer helps to seal any penetrations of the roof. This includes nails for the shingles or lag bolts fastening the solar PV to the roof rafters. There is often concern about adding extra fasteners to attach the solar, because of the additional penetrations on the roof and potential leaks. The self-adhering modified bitumen layer helps to reduce this problem, along with the use of proper flashing (metal barriers around roof elements to prevent leaks).



- 3) More efficient panels require less space per given power output. One advantage of a system that has a smaller footprint is that it is less likely to be hit by flying wind-borne debris during a hurricane, although during such an event, debris can be everywhere. Also, there is more flexibility to place the panels on the sweet spot of the roof, away from edges (eaves, rakes, ridges, and corners) with maximum sunlight exposure.
- 4) While most panels cannot resist damage from wind-borne debris during a hurricane, nevertheless, panels do have a certain amount of impact resistance from hail. Check the technical specifications of the panels for impact resistance which is usually given as a hail-size diameter and speed (e.g., 1 inch at 52 mph).<sup>33</sup> The 2018 FEMA Recovery Advisory for Hurricanes Maria and Irma recommends that for hurricane prone regions, panels meet a very severe hail rating: VSH.
- 5) Regarding hurricane wind and wind-borne debris, there is little that can be done to make sure the panel is not damaged, but there are two key elements here: (a) make sure the panel stays in place on the roof, and (b) increase hurricane insurance to account for any panel damage. This should be done as standard practice for any significant home improvement susceptible to hurricane wind damage (Part 5).
- 6) Expanding on 5(a), it is vital that the panel remain on the roof, even if it is damaged. This will help protect the house and neighboring structures. Photos of hurricane damage for houses with solar panels often show that correctly installed panels will stay on the roof, even if there is damage elsewhere (see Figure 4-71). This is because on most of the roof, plywood is attached to the truss or rafters with nails, but where there are solar mounts, the panels are attached with a hurricane rated racking system and lag bolts that penetrate the plywood and structural framing, namely the truss (typically 2" by 6").
- 7) To ensure a strong installation of the solar panels, note the following:
  - (a) Figure 4-72 shows the materials commonly used to mount solar panels. This may differ by house type and contractor. Obtain a bid from three licensed solar contractors that include manufacturer's information





**Figure 4-71. House with solar panels hit by hurricane winds. Note the major damage along the rakes of the roof. As noted in Figures 4-58 to 4-60, pressure is greatest along the edges and can lead to loss of shingles and eventually the roof decking (plywood sheathing). Thus the best practices shown in Figures 4-61 to 4-64. The solar panels remained on the roof, held by the lag bolts attaching the panel system to the roof rafters or truss. Photo courtesy of One Block Off the Grid.**

**Figure 4-72. Typical Solar Mounting System. (A) Lag Bolt, in this instance,  $\frac{5}{8}$ " diameter and 3.5" length [see item (b) below]; (B) Flashing is used to prevent leaks from the roof penetrations. The flashing has a rubber seal at the top and bottom of where the lag bolt penetrates the plate [see item (d) on the following page]. (C) L bracket made by EcoFasten Solar. Items A, B, and C represent the parts of the system fastening the racking system to the roof (See Figure 4-73). In addition, there is the (D) Unirac Mounting System, which should have undergone wind testing and have approval by a Licensed Design Professional hired by the contractor [see item (c) on the following page]. As part of the racking system, there are (E) side clamps attaching the Solar PV panels (not shown) to the racking system.**

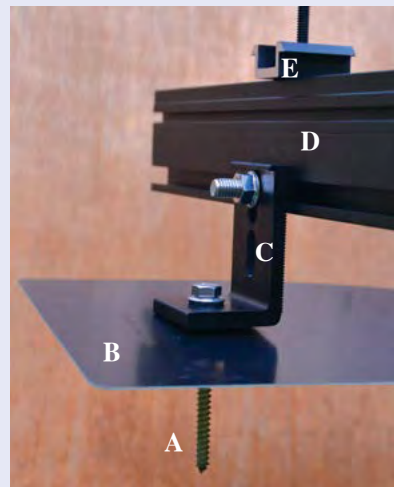

and testing on the materials to be used, including the racking system. While cost is an important factor, realize also that measures to make an installation stronger could add marginal cost.

(b) Lag bolts must go into the truss of the roof, not the sheathing (usually  $\frac{5}{8}$  inch plywood). Trusses are quite strong, and are typically 2 inches by 6 inches (really 1.5 inches by 5.5 inches). The contractor is likely to drill test holes with a small  $\frac{1}{8}$  inch drill bit to make sure the truss locations are exactly identified. Inspection inside the attic will reveal if the lag bolts have squarely hit the rafter or truss. This should be checked by the contractor and preferably the homeowner before the racking system is installed so that if a lag bolt did not fully engage a truss, the brackets can be relocated and properly fastened. It is not

uncommon for the lag bolt to miss the truss. The target, for any bolt, is to hit the middle  $\frac{1}{3}$  of the truss. The lag bolt should go at least 2.5 inches into the truss for the screw shown in Figure 4-72. Besides pilot holes to identify the truss, a larger pilot hole of  $\frac{3}{4}$  of the diameter of the lag screw can be drilled into the truss to prevent splitting of the wood.

(c) The key to keeping solar panels attached is proper fastening of the racking system to the roof with lag bolts, and proper fastening of the solar panels to the racking system.<sup>34</sup> Under the cited ASTM standard, the racking system should be approved by a Licensed Design Professional (LDP) who can approve structural designs in Hawai'i. ASTM also calls for the LDP to review the structural design, the sizing method, and the method of attachment for wind design loads under the applicable codes. The State Building Code Council adopted the Hawai'i State Building Code on November 13, 2018, which incorporates by reference the 2012 International Building Code. Ask a contractor for the letter from their LDP that certifies that the racking system and attachment methods meet the design wind forces and load combinations under the International Building Code. This can be readily provided.

(d) The ASTM E2766-13 standard also provides guidelines for flashing the roof penetrations. Flashing materials should be sufficiently durable and compatible to last the life of the installation. A polycarbonate sealant can be used to seal the gap, or fill the hole, between the lag bolt penetration and flashing for asphalt shingle roofs. The flashing should be shingled into the roof so that it lies under the upper shingle and over the lower shingle. The flashing should be fastened to the upper shingle with fasteners or polycarbonate sealant. In addition to flashing, a self-adhering modified bitumen layer can add additional water proof protection (see Figure 4-62). As noted previously, this is an upgrade to standard roofing but could be well worth the cost for those homeowners who reroof.

(e) It is not the responsibility of the homeowner to determine uplift wind loads on the panels and the number of fasteners required to resist these loads. This is the role of the contractor, and their licensed structural engineer or Licensed Design Professional. Nevertheless, the homeowner can relieve the need for design demands by placing the panels away from the edges of the roof, to where wind pressures

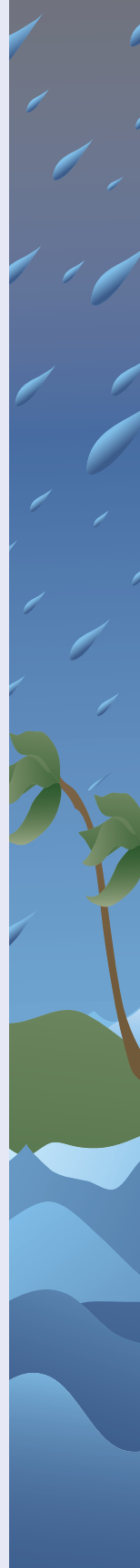

are less (see Figures 4-58 to 4-60 and 4-71, as well as Endnote 32). This should be the preferred location, given all other factors being equal (e.g., sun exposure, shadow effects, existing space, or location of existing vents). Due to some of these factors, there may be a need to build closer to the edge; however in such a case, extra fasteners or wider and/or longer lag bolts may be needed (see Figure 4-73). Check with a contractor if there is a need, and refer to Endnote 35. Key factors to determine a need are the roof zone, topography, and location of the house.



**Figure 4-73.** Fasteners used to attach the racking system and solar panels are shown. The fasteners represent parts A, B, and C of Figure 4-72. Where it was necessary to go near the rakes or edge of the roof, or the corner near the ridge, extra fasteners were provided, a change from every 4', or every other rafter, to every 2' but only for the areas near the higher wind roof zones. Extra fasteners were \$85 each. Federal and state tax credits pay for a portion of the increased cost. Check with a contractor whether extra fasteners are needed given the wind loads on the installed panels for the area and the uplift resistance per-fastener (Endnote 35). Another alternative to extra fasteners are wider and/or longer lag bolts into the roof rafters.

Note that many of the principles in this section are for solar photovoltaic panels that are parallel to the roof surface. Panels that are not parallel represent an unusual, but still common, scenario (refer to the Guide to the Wind Design Provisions of the Hawai'i State Building Code cited in Endnote 35). In either case, a licensed professional (engineer or architect) should be consulted that is either hired by the homeowner, or is at least part of the contractor's or installer's professional design team. Thus, when a licensed contractor or installer is hired, an important consideration is the expertise, reliability, and integrity of the design professionals in the company. In addition to providing this information on their design team, the company should be able to provide a full background on all equipment used, including wind-testing on the equipment and how loads were calculated, either from the manufacturer or the installation company.

The purpose of this Part is not to have homeowners design their own system, but to be informed about best practices for installation so that they can intelligently discuss these with their licensed contractor. With better educated homeowners, more secure and safer systems can be installed.

### **Tips for a resilient, adaptive, and sustainable solar photovoltaic system:**

**Resilient** – Follow the other tips in this section to make a strong solar system.

**Adaptive** – Reduce a household’s carbon footprint by sizing a solar system for a house and an electric car. In one example, costs to oversize solar for an electric car increased by 20-25%, but savings more than doubled when electric bills and gasoline purchases are factored in. Payback is usually 5 to 10 years. Do the math for any situation. There is a Federal Tax Credit of 30% with no cap expiring 12/31/2019 and a State Credit of 35% capped at \$5,000 with no expiration at the time of this writing.

**Sustainable** – Solar panels also protect the roof from harmful UV sunlight and the elements. A strongly built roof and solar system will provide lasting energy for decades. A quality system is designed for 25 to 40 years and can last longer. Maintain the system by periodically having the installer check bolt connections with a torque wrench. Double-nut panel clamp bolts. Configure with microinverters so that if one panel is damaged, the system can continue to produce power. Battery backup could provide emergency power when the grid is down.

## 4.8 Exterior Opening Protection (Garage and Doors)

Exterior opening protection covers work to protect windows, doors, and garage. This is to maintain the wind- and rain-resistant envelope of a house. Exterior window protections were covered in Parts 4.3 and 4.4.

The garage door is a significant weakness during a hurricane due to its large area and the stress it is subject to. Garage door options include: (i) replacement with a stronger door, (ii) horizontal bracing, (iii) vertical

bracing, or (iv) other types of a bracing kit. For many garage doors the vertical bracing is a popular and reasonably priced option (see Figure 4-74).

**Figure 4-74. Vertical braces such as these can be deployed during high wind events to strengthen the garage door. The braces are secured from the header over the garage door to fasteners installed on the concrete floor. Deployment and breakdown take about 10 minutes each. The windows have been covered with a laminate film and secured with silicone structural sealant.**



More information on the design of new garage doors or on how to retrofit existing ones can be obtained in *Home Builder's Guide to Coastal Construction* (FEMA P-499, 2010), fact sheet 6.2 (see Reference Link 49); *Local Officials Guide for Coastal Construction* (FEMA P-762, 2009), Chapter 10 (see Reference Link 50); *Protecting Your Property from High Winds* (2011) (see Reference Link 51); *Mitigation Assessment Team Report: Hurricane Harvey in Texas* (FEMA P-2022, 2019) (see Reference Link 52). A garage door should meet the design wind speed requirements for the area or be retrofitted to withstand the design wind speed. However, because of structural limitations in the original door, this may not always be possible.

For double-entry doors, there should be slide bolts at the top header and bottom threshold of the inactive door, a deadbolt with at least 1-inch throw length between each door, and three hinges for each door. This requirement is similar to other guidelines for single-entry doors, which call for at least three hinges and a bolt long enough to penetrate the 2 by 4-inch framing of the door.<sup>36</sup> Whenever entry doors are fortified, at least two of them must be operable for access and exiting at any time.

## 4.9 Safe Room

A safe room is a room designed to provide enhanced protection from the strongest of winds (e.g., hurricane categories 3 to 5). In the Hawai'i State Building Code adopted on November 13, 2018 by the State Building Code Council, the provisions for a Hawai'i residential safe room are provided (see Reference Link 53). Specifications cover the design of the room, including ventilation, exiting, occupancy, communication, and siting requirements. Safe rooms should not be built in areas with any risk of flooding such as Special Flood Hazard Area or a dam failure inundation zone (see Part 2.4 Figures 2-12 and 2-13, and Part 3.7).

Additional information on safe rooms can be found in the following documents: *Taking Shelter From the Storm: Building a Safe Room for Your Home or Small Business* Fourth Edition (FEMA P-320, 2014) (see Reference Link 54); *Design and Construction Guidance for Community Safe Rooms* Third Edition (FEMA P-361, 2015) (see Reference Link 55); and the safe room website: <http://www.highwindsaferooms.org>.

### 4.9.1 The Safe Room: Tax Credits and Cost

On Kaua'i, residents who build a safe room can get a credit on their property taxes. A house with a safe room gets a \$40,000 safe room exemption in addition to the \$40,000 primary residential tax exemption. For a \$250,000 house on Kaua'i with a safe room, property taxes are based on a value of \$170,000. This would save about \$200 per year in property taxes.

It is much less expensive to build a safe room at the time a new house is built. FEMA notes that while construction costs vary nationwide, the cost to build a safe room inside a new house (which can also double as a master closet, bathroom, or utility room) ranges from \$8,000 to \$9,500 for 8-foot by 8-foot room and between \$14,000 and \$17,000 for a 14-foot by 14-foot safe room (from *Taking Shelter From the Storm: Building a Safe Room for Your Home or Small Business* Fourth Edition (FEMA P-320, 2014) (Reference Link 54).

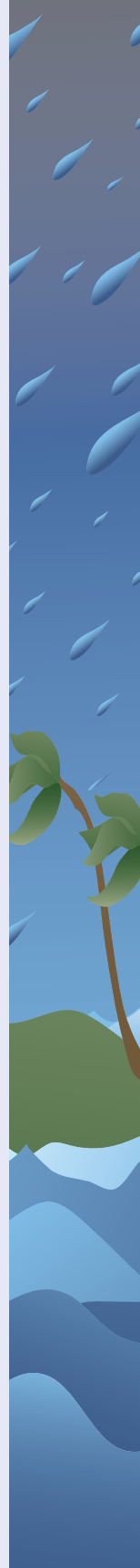

Under the new Hawai‘i State Building Code, houses will be required to have window coverings or a safe room. This will be required unless the counties amend these provisions.

When building or buying a new home, ask an architect, developer, home builder, or licensed contractor to provide a low cost estimate to build a safe room in a master closet or other suitable room. A guideline for cost could be the lower end of the estimate provided by FEMA. The additional cost can then be wrapped into the original home mortgage. As noted above, safe rooms should not be built in any location where there is risk of flooding.

## 4.10 Trees

Falling tree limbs or branches can do considerable damage to houses that are impacted. If it is not possible to remove a tree situated near the house, at least trim it so that air can flow through more easily. If branches and vines are too thick for adequate air flow, the tree will act like an umbrella, catching the wind and toppling. Another alternative is to trim branches that reach directly over the roof of the house. Generally, a licensed tree trimmer should be hired to perform this work.

When Iselle hit Hawai‘i County as a weakened tropical storm on August 7-8, 2014, many houses were damaged by albizia trees, which topple easily, even in winds less than hurricane strength. These trees are located in other counties and their potential to damage nearby houses, infrastructure, and power lines should be evaluated. See also the Hawaiian Electric publication *Planting the Right Tree in the Right Place* (Reference Link 56).



**Figure 4-75.** FEMA recommends that the distance between a tree and house should always be greater than the height of a full-grown tree to prevent the tree from impacting the house if it does fall.<sup>37</sup>



## 4.11 Earthquake Retrofit

The need to retrofit houses to address earthquakes is greatest for Hawai‘i County and becomes less urgent with each island to the northwest (see Figures 2-10 and 2-11). The reader is referred to the report *Structural Seismic Retrofits For Hawai‘i Single Family Residences With Post and Pier Foundations Volume 1* (2009) prepared for the FEMA Hazard Mitigation Grant Program (Ian Robertson and Gary Chock, 2009). In this report, three simple retrofit designs are provided to strengthen post and pier foundations, which are common throughout the islands. See Part 4.1.2 for a demonstration of a retrofit on O‘ahu. Work on Hawai‘i County would be similar, but more of the posts would need to be retrofitted and shear walls added at the corners. The homeowner should consult a licensed structural engineer or architect before beginning this work.

Retrofitting a house so that it has a continuous load path connection will reduce the risk of damage from both a hurricane and an earthquake. The primary concern during an earthquake is the horizontal forces from the earth shaking. The primary concern during a hurricane is the horizontal forces of wind pushing against the structure, but also the vertical uplift forces on roofs which act like airplane wings in the strong wind. The retrofit designs provided in the post and pier report can address the horizontal forces of hurricanes and earthquakes, and significantly reduce the risk of damage from uplift forces associated with a hurricane.

Ideally, for complete uplift protection between the walls and foundation, the horizontal and vertical loads should be transferred from the foundation blocks to the ground. This is a more complicated and expensive retrofit that will require the assistance of a structural engineer. Additional resources for consideration include the *Homebuilders Guide to Earthquake Resistant Design and Construction* (publication number FEMA P-232, 2006) (Reference Link 57) and the Simpson Strong-Tie publication *A Step-by-Step Guide to Retrofit Your Home for Earthquakes* (2012) (Reference Link 58).

In addition to protecting the house structure from earthquakes, consider also protecting the house contents. See FEMA’s How to Series *Protect*





*Your Property from an Earthquake* (2008) (Reference Link 59) which covers basic safety measures like: anchoring large equipment, bookcases, filing cabinets, propane tanks, and gas cylinders; bolting sill plates to the foundation; bracing crippled walls; securing drawers, cabinets, picture frames, mirrors, computers, and appliances; and using flexible connections for gas and water lines.

## 4.12 Flood Retrofit

Some excellent sources of information for protecting property from flooding are found in FEMA publications from the Building Science Branch. Especially helpful are FEMA P-55 *Coastal Construction Manual: Principles and Practices of Planning, Siting, Designing, Constructing, and Maintaining Residential Buildings in Coastal Areas*, Fourth Edition, (2011) (Reference Link 60) and FEMA P-499 *Home Builder's Guide to Coastal Construction* (2010) (Reference Link 61).

FEMA P-312 Homeowner's Guide to Retrofitting, Third Edition, (2014), (Reference Link 62) covers: elevation of a home (an expensive but effective option); wet-flood proofing a building; relocation and other methods; and protection of service equipment.

In many cases flooding on a property can be caused by poor drainage. If this is the case, it may be of great benefit to address the drainage issue with the advice of a licensed civil engineer.

Many homes flooded on O'ahu and Kaua'i during the April 15, 2018 rainfall event, which released a record 49.69 inches of rain over a 24-hour period. Some FEMA publications that would be particularly useful for these locations are: *Protect Your Property from Flooding* (Reference Link 63) and the brochure *Protect your Home from Flooding – Low Cost Projects You Can Do Yourself* (Reference Link 64). These publications cover: raising electrical system components, anchoring fuel tanks, installing sewer backflow valves, and building with flood resistant materials. These are very important topics especially for areas with a history of repeated flooding. See also Appendix D.

## 4.13 Wildfire

As covered in Part 2.6.2 the risk of wildfire in Hawai‘i is greater than commonly believed, and likely to grow with climate change. The history of wildfire in Hawai‘i, and the 2018 Camp Fire in California, show how deadly and destructive this hazard can be. Studies have shown that 80 percent of the homes lost to wildland fires could have been saved if their homeowners followed a few simple, fire-safe practices (Hawai‘i Wildfire Management Organization (“HWMO”): <http://www.hawaiiwildfire.org>).

### Key steps:

- 1) Manage vegetation and create a defensible space by clearing unmanaged dried and dead vegetation and creating fuel breaks. This will allow firefighters the space they need to protect the community and is especially important at the wildland/urban interface.
- 2) Prevent fire embers, which can destroy homes a mile away, from setting local structures on fire. Go to the HWMO – READY, SET, GO! Brochure (Reference Link 65) to learn how to create a defensible space and protect roofs, eaves, vents, windows, door, balconies, and decks. Similar to hurricane wind and water, embers can enter any opening and cause destruction. Some structures are more susceptible (e.g., wood-shake roofs, wood fencing, and post and pier structures which have a space underneath for embers to enter and ignite dead vegetation or combustible materials like old lumber).
- 3) Consider a fire sprinkler system and have fire extinguishers handy as well as multiple garden hoses that can reach any area of the house.
- 4) Replace combustible materials with non-combustible (e.g., wood fence with metal fence).
- 5) Know the risk, as covered in Part 2.6.2.
- 6) Have a go-kit ready and an evacuation plan, as covered in Part 3.2.



- 7) Know what do to for a fire (“READY, SET, GO”) versus for a flood (“TURN AROUND DON’T DROWN”) (Part 3.7) versus for an earthquake (“DROP, COVER, AND HOLD”) (Part 3.8) versus for a hurricane (Part 3.6) or tsunami (Part 3.4). **All members of the family should know what to do regardless of the hazard – see summary Table 3-5.**

**Tips for a resilient, adaptive, and sustainable yard:**

**Resilient** – High-moisture content, drought-resistant vegetation can reduce the risk of fire. Non-native, lush plants and trees often drop debris and can be a fire hazard during dry conditions. Use of native plants will thus reduce fire risk.

**Adaptive** – With less rainfall and more drought conditions likely (see Parts 2.6.1 and 2.6.2), the use of native plants and trees can help homeowners adapt to a future world by surviving under harsh conditions and increasing carbon dioxide uptake.

Plant trees for a cooler house and environment, but plan for wildfire and hurricanes by considering plant types and spacing for potential damage to roofs and power lines while creating a defensible space. See also: Part 4.10 and the Hawaiian Electric Company publication “Planting the Right Tree in the Right Place” at: (Reference Link 66). Use actual hazard risk to guide your decision (Part 2).

**Sustainable** – Native dryland plants and trees are specially adapted to local conditions and require less water, fire maintenance, and upkeep. Go to the HWMO “Ready, Set, Go” brochure cited above to see pictures of 27 native plants and trees that may be suitable for the local area.

## 4.14 Electrical Issues for the House

The *Handbook for Emergency Preparedness*, distributed by Hawaiian Electric, Maui Electric, and Hawai‘i Electric Light (see Figure 4-76) is an important publication to have on hand for reference. The Hawaiian Electric handbook is in English, Cantonese, Ilocano, Korean, Vietnamese, and comes in a Keiki Version.

The Hawaiian Electric handbook provides useful information on turning off the power, in case of an emergency, through the main breaker switch, circuit breaker panel, or fuse box. The handbook also describes ground fault circuit interrupters (GFCI) and their role in protecting people from severe or fatal shock. GFCI's are commonly found in kitchens, bathrooms, laundry rooms, or other places where water and electricity are close together. If not already installed, consider having them put in by a licensed electrician. For coastal properties, any light switches, wiring, and receptacles that are below the design flood elevation should be protected with ground fault protected electrical breakers (*Home Builders Guide to Coastal Construction*, FEMA P-499, 2010 - Fact Sheet 8.3 – referenced in Endnote 29).

The Hawaiian Electric handbook also describes indoor and outdoor electrical safety tips that are applicable during normal times and emergencies. During a hurricane there could be many downed power lines and associated power outages. The handbook provides tips for negotiating downed power lines as well as a reminder to call 911 if one is spotted or if someone is being shocked. Many tips are provided for dealing with power outages, which is especially important to know during and, potentially, for a while after a hurricane. For instance, a month after Hurricane Iniki hit the island of Kaua'i only 20 percent of the power had been restored.

**Figure 4-76. The Hawaiian Electric handbook covers many of the topics dealing with electrical safety and power outages. Printed copies can be obtained at the customer service departments for Hawaiian Electric, Maui Electric, and Hawaiian Electric Light (Reference Link 67).**



## 4.14.1 Energy Efficiency

One general suggestion is to improve energy efficiency to be more resilient, adaptive, and sustainable. This can be achieved by replacing equipment and appliances after they have outlived their normal life. For example, if the lights, a television, refrigerator, air conditioner, or washer need replacing, consider products with the Environmental Protection Agency's (EPA)

Energy Star label (see Figure 4-77). These products may cost slightly more, but over their lifetime the energy savings will far outweigh the small initial cost increase.



**Figure 4-77. Items with the EPA’s Energy Star label use much less energy than standard models. Items include washing machines, dishwashers, air conditioning units, freezers, refrigerators, and light bulbs. For example, a typical refrigerator may require 1,500 watts to start up and 500 watts to run.<sup>38</sup> An average sized Energy Star refrigerator requires 1,200 watts at startup and 200 watts for running. This saves on the electric bill and makes coping during a power outage easier, as explained below.**

Energy efficient equipment will be especially useful during an emergency when it may be necessary to use alternative forms of power with limited supply. For example, a regular 100-watt lamp running off an emergency power station (essentially built around a car battery) may run for two hours. That same emergency station can run a modern energy efficient 15-watt light emitting diode (LED) bulb for more than 13 hours with the same light output. Similarly, an EPA Energy Star refrigerator coupled with a fuel-efficient generator could keep food cold for one to two days on just a gallon of gas. This is due to the efficiency of the refrigerator and the fact that most refrigerators do not need to run continuously.<sup>39</sup>

**Energy efficiency leads to a resilient, adaptive, and sustainable home:**

- 1) Purchase Energy Star products when household appliances or other items reach the end of their useful life to reduce energy demand during normal conditions and in an emergency.
- 2) LED lights are cooler, more energy efficient, and can be used for household light fixtures to reduce energy or in flashlights to last longer during an emergency.
- 3) Keep houses cool with the tips on windows (Parts 4.3.6 and 4.3.7), roofs (Parts 4.6), and landscaping with trees (Part 4.13).
- 4) Follow the Hawaiian Electric publications “Cool Tips,” “Energy Tips and Choices,” “Power to Save,” and “101 ways to Save” (Reference Link 68).

## 4.14.2 Generators

Some households may require uninterrupted power because of the critical needs of some family members. For example, the elderly, disabled, or sick may require a respirator, dialysis machine, or other medical equipment. Some medicine such as insulin, which is often stored over a month, may need to be refrigerated. For many families, the most important major power requirement is to run a refrigerator or freezer. If use of a refrigerator is essential or there are other critical power needs for medical or other purposes, consider purchasing a portable generator.

This handbook does not recommend any particular generator or brand. However, when considering a generator, read reviews of generators that are published for the consumer and look first at power needs and then at cost, reliability, quietness, and fuel efficiency, among other factors:

1. Power needs. Size the generator so that it runs the necessary or desired equipment for an emergency. It will make a difference if just the refrigerator is run, versus the refrigerator, lights, and other equipment. Each piece of equipment is different. General guidelines from the manufacturers are available in the form of charts and tables for equipment power needs. For more accurate estimates, call the manufacturer or buy a meter that measures running and starting wattage. Dealers who sell the units can also give good advice on sizing a generator.
2. Fuel efficiency. During an emergency there will be limited fuel supplies. The amount of power needed and the fuel efficiency of the generator will determine whether one or two gallons per day will suffice versus five or six gallons.
3. Quietness. Generators are usually noisy, but some are quieter than others. If a generator is necessary, family and neighbors will appreciate if the generator is quieter.

Never run a generator indoors or in the garage because of the buildup of carbon monoxide gas, which cannot be detected by smell. Good ventilation

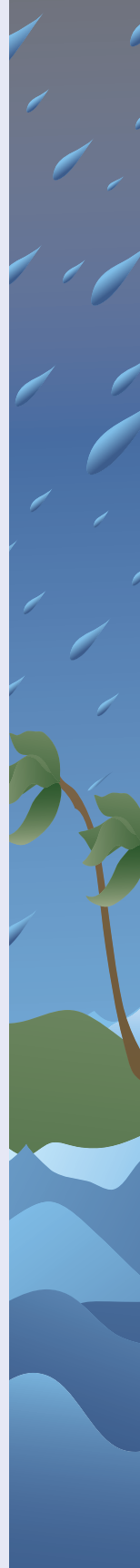



is required: operate a generator outside and away from open windows. Do not hook up a generator to the house power supply without a licensed electrician. Most people use extension cords to connect to the appliances, and the cord should be of sufficient gauge to carry the power load. Go to the Florida Power and Light website for tips on running a generator during an emergency (Reference Link 69).

A general guideline for running a refrigerator with a generator is to keep it and the freezer at the coldest setting. Refrigerators may only need to run a few hours a day to preserve food.<sup>39</sup> A four-hour off, one-hour on cycle is commonly used. Using a refrigerator thermometer, aim to maintain 40 degrees in the refrigerator compartment and 0 degrees in the freezer. Open the refrigerator door as little as possible. There are also wireless refrigerator thermometers with alarms, to monitor the temperature without opening the door, for under \$30. When temperature gets above a certain level, e.g., 40 degrees, turn on the generator. For those without a generator, use ice prepared beforehand to keep the refrigerator cold, or put key refrigerated items in a cooler with ice.

When in doubt about the safety of any food, do not eat it. In general, eat food from the refrigerator first, then from the freezer, and, last, eat nonperishable supplies from your emergency supplies (see Part 3.1). For answers to food safety questions, go to the State of Hawai‘i Department of Health website (Reference Link 70) or call (808) 586-4400.

### 4.14.3 Power Stations

Power stations are found in many hardware stores and may have a radio, flashlight, air compressor, battery jump starter, AC outlet, and/or DC outlet built around a modified car battery. These units can come in handy during a power outage, since they can form part of a stock of emergency supplies and also provide limited emergency power. For example, many people discovered their wireless phones did not work during the power outages associated with the October 15, 2006, earthquake. If a cordless phone does not work because the base of the unit has no power, an independent power station could supply electricity so that calls could be made. (An alternative



is to use a corded phone.) It should be noted that after an emergency, there may be many other reasons the phone does not work that are beyond personal control, such as heavy traffic or loss of function of the whole phone system.

## 4.15 Licensed Contractors

Selecting a good, licensed contractor to do any of the described work is very important. This handbook does not recommend or endorse any particular company, as it is up to the homeowner to select a preferred company and verify their record. Make sure the contractor is licensed, insured, has not received complaints, and always ask for a list of referrals. Contractor records can be checked at the State of Hawai'i Department of Commerce and Consumer Affairs, Regulated Industries Complaints Office. The number is (808) 587-4272.

There are several reasons to use a licensed contractor.

- 1) Licensed contractors have the training and experience to obtain a contractor's license. This license requires a background check from the state Contractors License Board.
- 2) Licensed contractors have workers compensation and liability insurance. This protects the homeowner and their property if someone is injured.
- 3) A licensed contractor can get and sign building permits.
- 4) The Contractors Recovery Fund is available if something goes wrong after hiring a licensed contractor. Go to the DCCA webpage for more information (Reference Link 71).

The City and County of Honolulu Department of Emergency Management has a list of contractors performing work in the area of hurricane protection (see Reference Link 72).





This compilation is not a recommendation or endorsement of any particular company, but a listing of companies performing work in this area that can be further investigated.

Contractors can also be found in the local yellow pages using the key word “hurricane” for locating those who perform work in the area. When selecting a company, it is still necessary to do the proper due diligence and check their qualifications (see Reference Link 73).

Hiring a licensed contractor is very important. After Hurricane Iniki, many families lost savings and insurance funds as a wave of unlicensed contractors flooded the impacted area in search of work. A good resource for finding a licensed contractor is the particular organization on each island that deals with contractors or the umbrella organization for the state, the General Contractors Association of Hawai‘i. These organizations can provide direction and are listed below:

General Contractors Association of Hawai‘i: (808) 833-1681

Contractors Association of Kaua‘i: (808) 246-2662

Hawai‘i Island Contractors Association: (808) 935-1316

Before having any extensive work performed, see a licensed architect or structural engineer, depending on the particular work that needs to be done. Even if the homeowner plans to do the work personally, a licensed professional should be consulted for initial guidance, since every house is slightly different.

# Part 5

## Protecting Property with Insurance

There are two ways to protect property from natural hazards. The proactive way is to strengthen the house to address the individual hazard. If, however, there is still damage, insurance can provide resources to aid recovery. It is best to have both a strong house and insurance, because no matter how strong a house is, there is always some residual or unknown risk. As an example, a house may be fortified for hurricane winds or rain, but a tree from a neighboring property could fall on the house.

Hurricane insurance is important for all residents of Hawai‘i. Flood insurance is important for those in a high-risk flood zone (see Figure 2-13), or for those subject to periodic flooding, even if outside a high risk flood zone. Banks will require hurricane insurance and flood insurance if in a high risk flood zone. Earthquake insurance is particularly important for those on the island of Hawai‘i and, to a lesser extent, Maui; however, earthquake insurance may not be available or can be very expensive.

It is important to understand that hurricane insurance will not cover damage from flooding, and flood insurance will not cover damage from a hurricane. Sometimes it is difficult to determine if damage from a hurricane came from flooding or wind. As a general guideline, if the damage or even flooding came from the top down (roof blows off and rain floods the house) then hurricane insurance would cover the damage. If the damage came from the bottom up, such as a river overflowing its banks due to hurricane rain, then flood insurance would cover.

### 5.1 Hurricane Insurance

To protect a property from the winds of a hurricane, hurricane insurance is needed, since a regular homeowner’s policy will not cover hurricanes. Coverage is typically provided in terms of replacement costs, or the cost to rebuild the house. Market value is irrelevant. The homeowner typically selects a deductible, for example 1–2 percent of the cost to rebuild.



In Hawai‘i, some homeowners do not have hurricane insurance, particularly those without a mortgage. Also, older homes (built before 1959), or those in poor condition may have difficulty in qualifying for hurricane insurance. If insurance is available, it is very expensive and provided by only a few out-of-state companies. Nevertheless, the market for insurance is changing, so continue to check for new and better availability. For homes without hurricane insurance, it is even more important to strengthen the house, or there could be a major loss during a hurricane. Ideally, have both a strong house and insurance.

Hurricane insurance policies vary for each company, so it is important to check with an insurance agent for the following:

**Discounts for retrofit:** Not all companies provide discounts for hurricane protective devices, but where available these discounts over time can pay for the cost of certain retrofit upgrades.

**Coverage:** Make sure coverage includes: (i) the main structure, (ii) detached structures, (iii) the house contents, and (iv) expenses during loss of use (such as hotel stays). Only the first item is required by the banks, so there may not be sufficient, or any, coverage for the remaining items. This coverage will vary by company. **Since contents coverage is important, take the time to inventory all valuable possessions with photographs or video before an event.** This will help the claim process.

**Hazards covered:** Some policies may cover only hurricanes, others only named storms (hurricanes and tropical storms), and others tropical cyclones (hurricanes, tropical storms, and tropical depressions) (see Part 2.2). A policy that covers tropical cyclones would be more comprehensive. Know how hurricane insurance may compare with regular homeowner’s insurance, which can cover wind damage but not a hurricane. Is there a gap in coverage? Review all policies, since they can be significantly different from one company to the next.

All of this can be covered by consultation with an insurance agent. It is important for homeowners to read and understand their current policy. Probably one of the most important items to cover is replacement value which is affected by the following factors:

**Inflation:** Does the policy have an inflation guard that increases each year as the cost to rebuild goes up? Construction costs have steadily increased and may increase even more so after a natural disaster.

**Building codes:** As building codes change, the cost to replace a house can go up, due to increased design and building demands. This is irrespective of materials or wage inflation.

**Surge demand:** After a hurricane, there can be widespread damage and very few contractors or supplies available to perform repairs. After Hurricane Iniki, it took up to two years for homeowners to repair their homes because of the heavy demand. This surge can result in an increase in cost to rebuild. Some homeowners have chosen to increase their insurance coverage by 30–40 percent to account for an expected spike in future construction costs after a hurricane.

**Improvements:** Additions or improvements to a house made since the initial policy purchase may not be covered, so it is important to have a periodic appraisal to ensure coverage is adequate. Have there been improvements to the bathroom or kitchen, an extension to the house, or a solar system added? All of these factors affect replacement cost.

Understand these factors to set an appropriate amount for hurricane insurance.

### 5.1.1 Insurance Discounts for Installation of Hurricane Protection

Some, though not all, insurance companies offer substantial discounts in hurricane insurance premiums as an incentive to strengthen the insured structure. These discounts are possible because the retrofits reduce hurricane risk, allowing the company to reduce premiums. The discounts are available for:

- 1) Roof-to-wall connection (hurricane clips) (typically 10 percent off)
- 2) Wall-to-foundation connections (typically 10–12 percent off)

- 3) Window coverings (15–18 percent off for single-family houses and 18 percent off for condominiums)

Check with an insurance agent as to the availability of the discounts and the specific requirements needed to obtain them. Each company is different. Conceivably, if all three strengthening measures are performed, as much as 35 percent could be saved on hurricane insurance premiums. To obtain the insurance discounts, typically a letter must be submitted from a contractor verifying that the work has been completed. If plywood shutters are built by the homeowner, pictures must be submitted to substantiate the work. If the continuous load path connection or hurricane clips were built in, the premium may already be adjusted based on the date of construction (see Table 4-1).

Consider work to strengthen a house as a home improvement that adds value and longevity while protecting family and offering peace of mind. If using a home improvement or home equity loan to pay for the work, it may be possible to get: (i) discounts on hurricane insurance premiums, (ii) a lower interest rate because the house is used as collateral, and (iii) a tax deduction on the interest (check with an accountant or financial institution).

## 5.2 Flood Insurance

Only separate flood insurance will provide coverage from flooding. Typical homeowner's insurance will not cover floods. Hurricane insurance generally will not cover floods, unless wind damage from a hurricane leads to rainfall intrusion and subsequent water entering the house. However, check individual policies to be certain.

Flood insurance will cover inundation or flooding for homes near a river, stream, or along the coastline. In addition, mudflows (defined as movement of the land by viscous water saturated soil) are covered, but landslides are not (for example, movement of the land by earthquakes). Coastal flooding and flooding from high surf, hurricane, and tsunami inundation are also covered.

Consider flood insurance if there is any risk of flooding. Insurance can be obtained even if outside a high risk-flood zone (see Figure 2-13). Flood insurance may also be needed near the coastline, a river, a stream system, any other body of water, or if there is poor localized drainage in a low- or moderate-risk zone.

Contact an insurance agent to determine whether they offer federally-backed National Flood Insurance. The following website provides general information on the flood insurance program including how to buy flood insurance and the costs (<https://www.floodsmart.gov>). For an interactive “cost of flooding” tool and help on finding agents issuing flood insurance for the local community go to: <https://agents.floodsmart.gov>. For low-risk areas, the cost of insurance is minimal compared to the protection it can provide.

## 5.3 Earthquake Insurance

To obtain protection from earthquakes, earthquake insurance is required since homeowner’s policies do not cover earthquakes. Earthquake insurance is especially important for residents on the island of Hawai‘i (see Figures 2-10 and 2-11). However, because of the great risk on this particular island, coverage is either very difficult to get, with only a few carriers providing it, or very expensive. Earthquake insurance is commonly offered with high deductibles.

If earthquake insurance cannot be provided, it is even more important to take steps to strengthen a house and protect the contents from ground shaking (see Parts 4.1.2 and 4.11). Note that if the house is built to modern standards with a hurricane protection system (i.e., continuous load path connection), this may offer some protection from earthquake shaking. Also, strengthening for an earthquake offers protection from a hurricane. This provides additional incentive for homeowners to act, particularly those who live in a high-risk area and cannot obtain earthquake insurance.

## 5.4 Miscellaneous Insurance Issues

It is possible that a homeowner could have three insurance policies: i) regular homeowner's insurance, covering fire, theft, burglary, and winds excluding hurricanes; ii) hurricane insurance, particularly if the house is under a mortgage; and iii) flood insurance, also required by banks if the house is in a high-risk flood zone (see Figure 2-13). That the banks require this insurance indicates the risk of a hurricane or a flood is real and the chance of losing mortgage collateral is unacceptable.

Homeowners should also understand the risk and not go uninsured. If there is any risk of flooding, homeowners should get flood insurance to lessen major impacts. Just one inch of flooding in a house could cost almost \$27,000 in damage for a typical one story 2,500 sq. ft. house according to the FEMA FloodSmart Calculator ([www.floodsmart.com](http://www.floodsmart.com)). The purpose of insurance is to provide protection from major catastrophic hazard events and transfer the risk from the homeowner to the insuring entity.

Older homes are especially vulnerable because: i) they may not have any hurricane or flood insurance if the mortgage has been paid and there is no bank requirement; and ii) older building designs did not account for flood or hurricane wind impacts. For these homes it is especially important to retrofit to lessen hazard risk and improve performance during an event. Because it is possible to strengthen, but only to a limited extent, insurance is also vital. It becomes even more important if there are no measures to strengthen the house.

A normal homeowner's policy does cover fire, including wildfires. Know the local risk and take measures to reduce the hazard (Parts 2.6.2 and 4.13). During the recent volcanic activity in 2018 (Part 2.5), many destroyed houses were not covered under lava insurance. However, many were able to make claims under their homeowner's policy under the fire provision. With regard to fire, a typical home insurance policy is about \$500 to \$600 a year. With lava coverage, it can cost more than \$3,000 a year. The key with insurance is to always know the risks and understand what the policy covers.



# Appendix A

## Emergency Contacts

### **Department of Emergency Management—City and County of Honolulu**

650 South King Street, Basement  
Honolulu, HI 96813-3078  
Ph: (808) 723-8960  
Fax: (808) 769-1492  
<http://www.honolulu.gov/dem/>

### **Hawai‘i Civil Defense Agency**

920 Ululani Street  
Hilo, HI 96720  
Ph: (808) 935-0031  
Fax: (808) 935-6460  
<http://www.hawaiicounty.gov/civil-defense>

### **Kaua‘i Emergency Management Agency**

3990 Kā‘ana Street, Suite 100  
Līhu‘e, HI 96766  
Ph: (808) 241-1800  
Fax: (808) 241-1860  
<http://www.kauai.gov/kema>

### **Maui Emergency Management Agency**

200 South High Street  
Kalana O Maui Bldg, 1st Fl  
Wailuku, HI 96793  
Ph: (808) 270-7285  
Fax: (808) 270-7275  
<https://www.mauicounty.gov/70/Emergency-Management-Agency>

### **State of Hawai‘i—Hawai‘i Emergency Management Agency**

3949 Diamond Head Road  
Honolulu, HI 96816-4495  
Ph: (808) 733-4300  
Fax: (808) 733-4287  
<http://dod.hawaii.gov/hiema/>

### **American Red Cross of Hawai‘i**

4155 Diamond Head Road,  
Honolulu, HI 96816  
Ph: (808) 734-2101  
Fax: (808) 735-8626  
<http://www.redcross.org/local/hawaii>

*Current as of July 26, 2019*

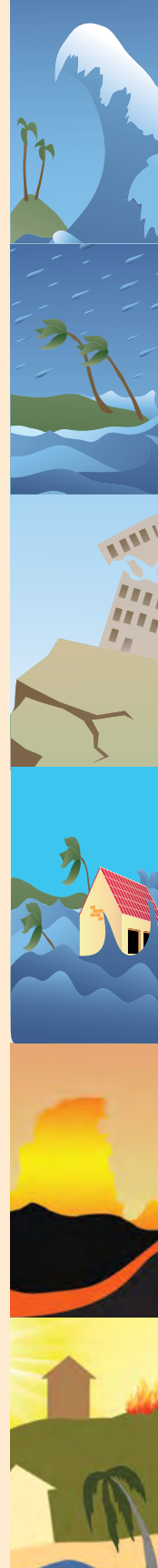



## Appendix B

# Resilience, Adaptation, and Sustainability

It is possible to make family, house, and the local community more resilient to hazards while also achieving the goals of environmental sustainability and climate adaptation. Implementing the seven measures below can help attain all three goals:

- 1) Follow the tips in Parts 4.3.6 and 4.3.7 to make windows strong, while reducing noise, heat intake, blocking UV radiation, and opening view planes.
- 2) Create strong and cool roofs to enhance comfort, lower energy costs, and increase the life expectancy of roofing materials such as asphalt shingles (Part 4.6). This will also reduce the urban heat island effect.
- 3) Install a strong solar system that considers wind loads for the racking system and attachment to the roof. Roof top equipment needs to stay on the roof during a hurricane (Part 4.7). Size solar for the house and an electric vehicle (“EV”) to reduce the household’s carbon footprint and make the return on investment even faster.
- 4) EV’s are the trend, with new models made by more companies with greater range at lower costs. Their use will reduce the carbon footprint, whether charging from a residential solar system, or the utility company, whose energy mix is increasingly renewable (wind and solar). By 2045, it is projected that the majority of personal light-duty vehicles will be EV’s powered by renewable resources. The large capacity battery in an EV can also be used to charge phones, flashlights, emergency battery packs during a power outage. For a multi-car family, strive to have at least one EV with a gas car to cover all usage scenarios (e.g., need for long range, large trunk space, limited parking, small or large number of passengers, use during a power outage, use during a gas shortage, etc.). In addition, there will be parking and high occupancy vehicle travel benefits as well as less maintenance and costs for an electric motor vs. a gas combustible engine.

- 5) Plant cooling trees but consider spacing for strong wind conditions to lessen the threat to power lines or rooftops (Part 4.10 and 4.13).
- 6) Xeriscape landscaping reduces the need for water, the burden during drought, and the risk during a wildfire. Native trees and plants are more drought resistant, have higher moisture content, and reduce wildfire risk (Part 4.13).
- 7) Energy efficiency (Part 14.14.1) and water conservation will have climate and environmental benefits, while increasing the ability to cope after a hazard.

For more information go to the City and County of Honolulu – Office of Climate Change, Sustainability, and Resiliency website (Reference Link 74), Hawaiian Electric Company’s Energy Savings Toolkits (Reference Link 75) and Hawai‘i County Department of Water Supply Tips on Water Conservation (Reference Link 76).

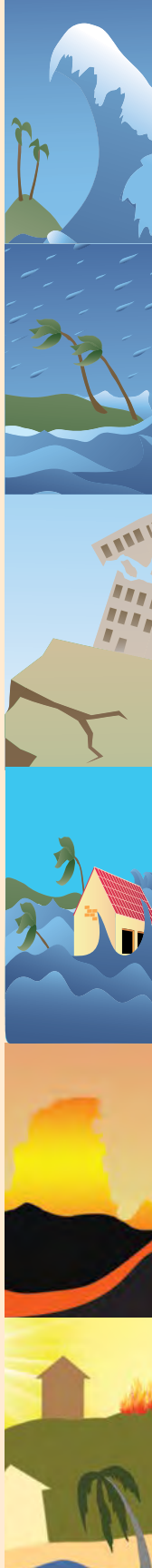



## Appendix C

# Working with the Community

For a community to be resilient (i.e., able to bounce back quickly from a hazard event), it is important that all individuals and all organizations (the core of the community) prepare. This book concentrates on helping individuals and families to prepare. Individuals who were planning to help in the community will be limited in their ability to assist if they or their families are not prepared. With an increased capacity to cope with different hazards, because of preparation, groups of individuals and organizations should be more able to assist the community by volunteering. This book encourages such effort. Here are some tips:

- 1) Learn about community resilience and the steps to take to prepare by requesting from the National Disaster Preparedness Training Center (NDPTC) free courses such as Community Resilience, Hurricane Awareness, and Flooding Hazards: Science and Preparedness (Reference Link 77). All NDPTC courses are FEMA certified and sponsored.
- 2) In addition to learning about best practices in the home through this book, there are many FEMA resources through the Building Sciences Branch (Reference Link 78). A recent emphasis by FEMA has also been on working with the community – See “A Whole Community Approach to Emergency Management: Principles, Themes and Pathways for Action” (Reference Link 79). Many of the resources in paragraphs 1) and 2) emphasize actions that individuals can do to empower organizations and the community. A resilient community requires all individuals and all organizations to be involved.
- 3) Whether an individual wants to lead disaster resilience efforts in their community or just help, a great way to get involved is to participate in the Hawai‘i Hazards Awareness and Resilience Program (HHARP) (Reference Link 80). The goal of HHARP is to enhance community resilience to multiple hazards through a facilitated education and outreach program that promotes hazard understanding and awareness, and offers tools and information resources to guide mitigation,

preparedness, response, and recovery. Led by the Hawai‘i Emergency Management Agency, the program helps communities prepare and become self-reliant by improving their ability to care for their own needs and reduce the impacts of natural hazards. Free HHARP resource kits are available to help communities organize, plan, and prepare for hazard events in their neighborhoods. Active HHARP communities on O‘ahu are Waimanalo, Kailua, Joint Base Pearl Harbor-Hickam, ‘Āina Haina, Mānoa, Wai‘anae Coast, ‘Ewa Beach, Hawai‘i Kai, Kāne‘ohe, Kahalu‘u, and Mililani. On Kaua‘i, the community of Hanapepe-‘Ele‘ele is active.

- 4) If physically appropriate, individuals can be of great benefit by joining a Community Emergency Response Team (CERT) for their county. CERT members get free training in first aid, search and rescue, light rescue, and disaster response. As a result, they help the police or fire departments during times of need.

Visit: Reference Link 81 for Hawai‘i County  
Reference Link 82 for Maui;  
Reference Link 83 for O‘ahu;  
Reference Link 84 for Kaua‘i.

- 5) Another way to help the community during time of disaster is to become trained in the humanitarian mission of the American Red Cross. Beginning training includes shelter operations, residential damage assessment, and providing emergency assistance. All disaster training is free. For more information, refer to: [www.redcross.org/hawaii](http://www.redcross.org/hawaii).
- 6) Get to know the neighbors. Contrary to popular belief, the most likely assistance that will come after a natural hazard that turns into a disaster is not from the local, state, or federal government. It is likely to be from the neighbors or local community members. This is because the government may be overwhelmed in responding to life threatening emergencies or maintaining critical infrastructure. A community will be better able to cope with a disaster when neighbors work together and with local government agencies as a team.

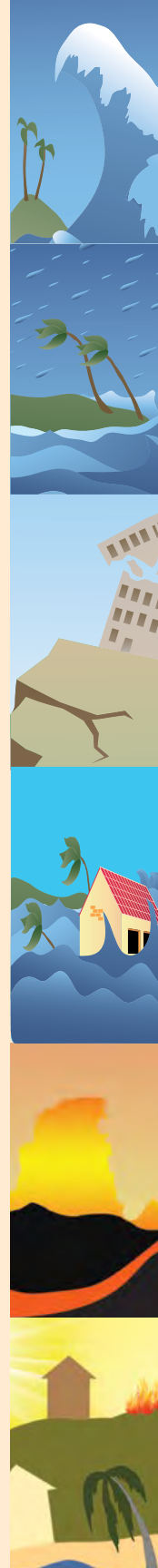

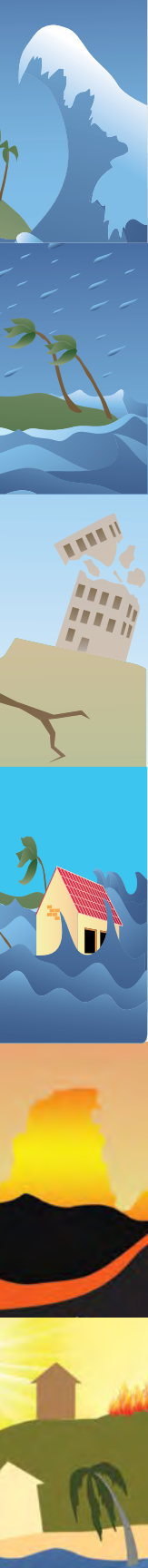

- 7) All citizens should sign up for emergency alert announcements for their county at their own civil defense or emergency management agency (see Appendix A and Part 3.3.2). Signing up means free watches, warnings, and advisories will be sent to registered computer mobile phones or personal electronic devices. These announcements alert users of advisories, watches, and warnings for the different hazards, provide tips for preparation, and even inform users of educational opportunities such as workshops or fairs.
- 8) Be proactive in preparing family members and the home. This can help the community by setting an example and showing leadership. When the time comes for an emergency, a prepared person will, at the very least, not be a burden to first responders. More likely they will be able to assist others. It is only the truly prepared that can help those that cannot help themselves (poor, elderly, or sick).

## Appendix D After the Storm

Hopefully, this section will never need to be used. Either a threatened hazard event will not have happened, or if it did, preparations were sufficient to limit the damage done. However, it is human nature that a large portion of the population will not prepare adequately. Thus, we are including this appendix, which is anticipated to grow with later editions of the handbook. For now, there are a few topics that are covered here.

**Mold:** One of the major issues after the April 15, 2018 floods, which damaged over five hundred homes on Kaua'i and O'ahu, was how to deal with mold. The key to controlling mold is to control the surrounding moisture. It is important to drain standing water and dry the area as quickly as possible using fans or dehumidifiers, if necessary. Remove all wet materials. In general, if there are porous and absorbent materials that cannot be cleaned within 24-48 hours, they should be discarded. Such materials could include drywall, carpets, and ceiling tiles. Non-porous hard surfaces can be cleaned with detergent and water. Remember to use personal protective equipment for eyes, nose, mouth, and skin. Never mix cleaners like bleach and ammonia (Reference Links 85, 86, 87).

**Flooding:** After a flood, there may be a tendency to repair damage and rebuild the same way. Always rebuild stronger. If flooding has happened more than once, elevate outlets and build with flood resistant, versus absorbent, materials (Part 4.12). For example, use tile with waterproof adhesive instead of carpeting, or install removable water-resistant panels instead of dry wall (Reference Links 88 and 89).

**Septic systems:** There are over 20,000 septic systems throughout the islands. During a flood, septic systems may back up. Generally, avoid pumping the tank, as a temporary solution, while there is still floodwater, since it may cause the tank to float. It is best to plug all drains and reduce water use in the house. After the flood and saturated conditions subside, pump the tank as soon as possible, and have the system professionally inspected and serviced (Reference Link 90).

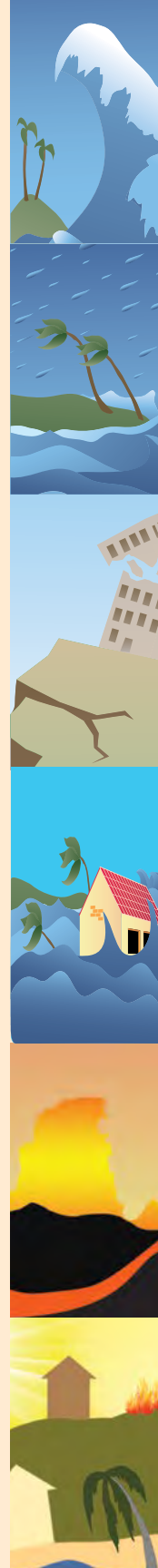

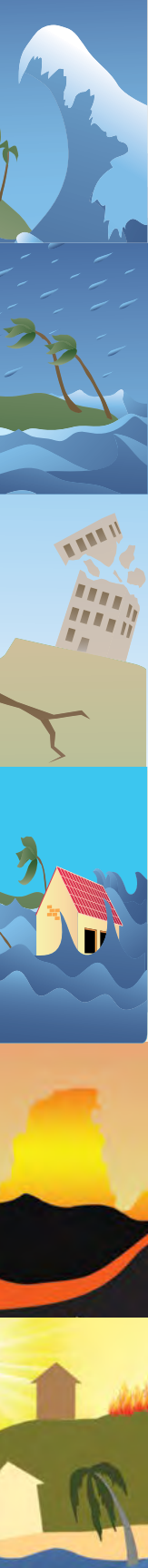

**Electricity:** Refer to HECO’s Handbook for Emergency Preparedness (Part 4.14). Do not touch power lines as they can still be live. Do not go in flood waters, since it is difficult to be sure of the depth or what is in the water. Never run generators indoors, in a garage, or near an open window (Part 4.14.1). Do not hook up a generator to the main house power line, as the back feed could shock electrical repairman. It is best to hook up individual pieces of equipment directly to the generator using proper gauged electrical cords.

**Insurance:** Contact an insurance agent right away to make a claim. They will need documentation of the damage in the form of pictures or video. Be sure to have an inventory of valuable items, as well as pictures or video of the home, from before the storm (Part 5). Do only enough repairs necessary to prevent further damage, or an emergency. Do not throw away damaged items, but set them aside for inspection. Do not begin permanent repairs until damage has been inspected by an adjuster and an insurer has approved the repairs and instructed them to begin.



# Useful Links

This page contains links to websites where you can get more information on planning for a natural hazard.

American Red Cross—Hawai'i State Chapter  
<http://www.redcross.org/local/hawaii>

Central Pacific Hurricane Center  
[www.weather.gov/cphc](http://www.weather.gov/cphc)

Department of Emergency Management, City and County of Honolulu  
<http://www.honolulu.gov/dem/>

Electrical Safety Foundation  
<http://www.esfi.org>

Federal Alliance for Safe Homes  
<http://www.flash.org>

FEMA Building Code Resources  
<http://www.fema.gov/building-code-resources>

FEMA Building Codes Toolkit  
<https://www.fema.gov/media-library/assets/documents/30423>

FEMA Building Science Branch  
<http://www.fema.gov/building-science>

FEMA Building Science Toolkit CD  
<http://www.fema.gov/media-library/assets/documents/92819>

FEMA Coastal Construction Manual: Principles and Practices of Planning, Siting, Designing, Constructing, and Maintaining Residential Buildings in Coastal Areas  
<http://www.fema.gov/residential-coastal-construction>

FEMA Home Builder's Guide to Coastal Construction Technical Fact Sheet Series  
<http://www.fema.gov/library/viewRecord.do?id=2138>

FEMA Local Officials Guide for Coastal Construction  
<http://www.fema.gov/library/viewRecord.do?id=3647>

FEMA Recommended Residential Construction for Coastal Areas: Building on Strong and Safe Foundations  
<http://www.fema.gov/library/viewRecord.do?id=1853>

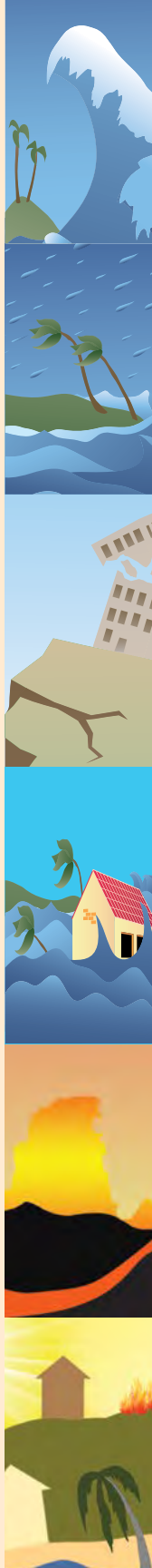



Hawai‘i Flood Hazard Assessment Tool  
<http://gis.hawaiiinfip.org/fhat>

Hawai‘i County Civil Defense  
<http://www.hawaiiicounty.gov/civil-defense>

Hawai‘i Emergency Management Agency (formerly State Civil Defense)  
<http://dod.hawaii.gov/hiema/>

Hawaiian Electric Company, Inc.  
<http://www.heco.com>

Insurance Institute for Business and Home Safety  
<http://www.disastersafety.org>

Kaua‘i Emergency Management Agency  
<http://www.kauai.gov/kema>

Maui Emergency Management Agency  
<https://www.mauicounty.gov/70/Emergency-Management-Agency>

National Weather Service Honolulu Forecast Office  
[www.weather.gov/hawaii](http://www.weather.gov/hawaii)

Official Site for the National Flood Insurance Program  
<http://www.floodsmart.gov>

NOAA Weather Radio  
<http://www.weather.gov/nwr/>

Pacific Disaster Center  
<http://www.pdc.org>

Pacific Tsunami Warning Center  
[www.tsunami.gov](http://www.tsunami.gov)

State of Hawai‘i, Coordinating Office for the National Flood Insurance Program  
<http://dlnreng.hawaii.gov/nfip/>

University of Hawai‘i Sea Grant College Program  
<http://seagrants.soest.hawaii.edu>

## Reference Links

1. <https://www.civilbeat.org/2018/11/analysis-lane-could-have-destroyed-thousands-of-honolulu-homes/> (see *PDC report, slides 7 and 17*)
2. <https://vog.ivhhn.org>
3. <https://vog.ivhhn.org/vog-fact-sheets>
4. [https://volcanoes.usgs.gov/observatories/hvo/hvo\\_gas.html](https://volcanoes.usgs.gov/observatories/hvo/hvo_gas.html)
5. [https://volcanoes.usgs.gov/observatories/hvo/faq\\_lava.html](https://volcanoes.usgs.gov/observatories/hvo/faq_lava.html)
6. [https://volcanoes.usgs.gov/volcanoes/kilauea/multimedia\\_chronology.html](https://volcanoes.usgs.gov/volcanoes/kilauea/multimedia_chronology.html)
7. <https://pubs.usgs.gov/fs/2011/3064/>
8. [https://volcanoes.usgs.gov/volcanoes/kilauea/geo\\_hist\\_summary.html](https://volcanoes.usgs.gov/volcanoes/kilauea/geo_hist_summary.html)
9. [https://volcanoes.usgs.gov/vsc/glossary/base\\_surge.html](https://volcanoes.usgs.gov/vsc/glossary/base_surge.html)
10. <http://seagrant.soest.hawaii.edu/climate-change-impacts-in-hawaii/>
11. <http://files.hawaii.gov/dlnr/cwrm/planning/HDP2017.pdf>
12. <https://www.cakex.org/sites/default/files/documents/Exec-Summary-PIRCA-FINAL2.pdf>
13. [https://static1.squarespace.com/static/5254fbc2e4b04bbc53b57821/t/5902a208ff7c50908d2bdf1f/1493344778012/Climate+Change+Impacts+on+Hawaii+Wildfires\\_FINAL.pdf](https://static1.squarespace.com/static/5254fbc2e4b04bbc53b57821/t/5902a208ff7c50908d2bdf1f/1493344778012/Climate+Change+Impacts+on+Hawaii+Wildfires_FINAL.pdf)
14. <http://www.hawaiiwildfire.org/hwmo-products/andFigure2-20>
15. [https://www.nesdis.noaa.gov/sites/default/files/asset/document/NOAA\\_NESDIS\\_Tech\\_Report\\_142-8-Climate\\_of\\_the\\_Pacific\\_Islands.pdf](https://www.nesdis.noaa.gov/sites/default/files/asset/document/NOAA_NESDIS_Tech_Report_142-8-Climate_of_the_Pacific_Islands.pdf)
16. <https://www.ready.gov/heat>
17. <http://health.hawaii.gov/docd/resources/disease-fact-sheets/>
18. [http://health.hawaii.gov/docd/disease\\_listing/dengue/](http://health.hawaii.gov/docd/disease_listing/dengue/)
19. [https://www.researchgate.net/publication/319686017\\_GLOBAL\\_AND\\_REGIONAL\\_SEA\\_LEVEL\\_RISE\\_SCENARIOS\\_FOR\\_THE\\_UNITED\\_STATES](https://www.researchgate.net/publication/319686017_GLOBAL_AND_REGIONAL_SEA_LEVEL_RISE_SCENARIOS_FOR_THE_UNITED_STATES)
20. <http://www.pacioos.hawaii.edu/shoreline/slr-hawaii/>

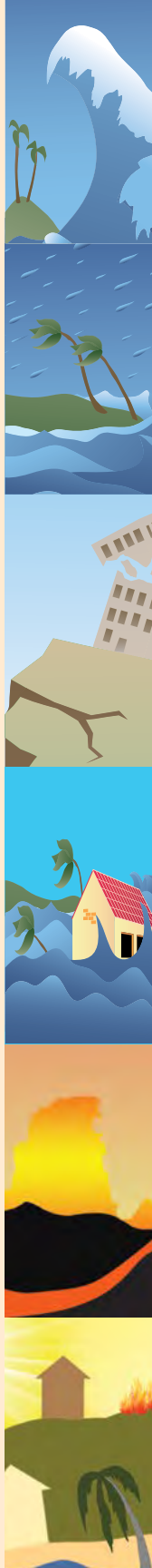

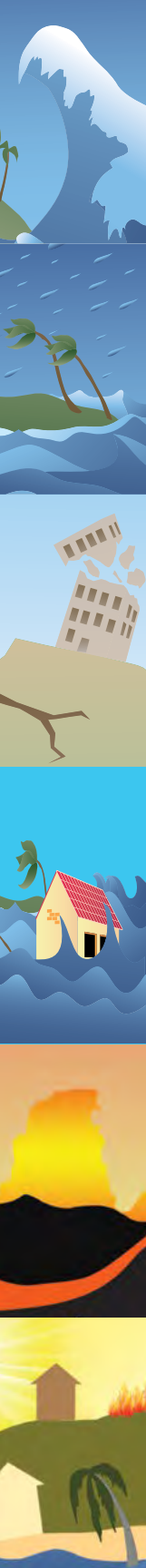
- 
21. [https://climateadaptation.hawaii.gov/wp-content/uploads/2017/12/SLR-Report\\_Dec2017.pdf](https://climateadaptation.hawaii.gov/wp-content/uploads/2017/12/SLR-Report_Dec2017.pdf)
  22. <http://www.soest.hawaii.edu/coasts/erosion/>
  23. <https://www.honolulu.gov/dem/preparedness/build-kit.html>
  24. <https://www.hawaiianhumane.org/disaster-readiness/>
  25. <https://www.fcc.gov/consumers/guides/wireless-emergency-alerts-wea>
  26. <https://www.kauai.gov/Government/Departments-Agencies/Emergency-Management-Agency-formerly-Civil-Defense/Notifications>
  27. <http://www.honolulu.gov/dem/preparedness/stay-informed>
  28. <https://www.mauicounty.gov/983/Active-Advisories-Watches-Notification-S>
  29. <https://countyofhawaii.bbcportal.com/>
  30. <http://dod.hawaii.gov/hiema/ham-radio-posse/>
  31. <http://dod.hawaii.gov/hiema/public-resources/tsunami-evacuation-zone/>
  32. <http://gis.hawaiiinfip.org/FHAT>
  33. <https://cca.hawaii.gov/ins/files/2016/01/Guide-to-Hurricane-Strengthening-of-Hawaii-Single-Family-Residences-Jan-2016.pdf>  
(See pages 25, 79-85)
  34. <http://dlnreng.hawaii.gov/dam/wp-content/uploads/sites/9/2018/09/Am-I-in-a-Dam-Evacuation-Zone-revised-091418.pdf>
  35. <https://journals.ametsoc.org/doi/10.1175/1520-0450%281998%29037%3C0951%3AMRPOTC%3E2.0.CO%3B2>
  36. <http://www.honolulu.gov/dem/preparedness/prepare-home.html>
  37. <https://cca.hawaii.gov/ins/files/2016/01/Guide-to-Hurricane-Strengthening-of-Hawaii-Single-Family-Residences-Jan-2016.pdf>
  38. <http://ags.hawaii.gov/bcc/building-code-rules/>
  39. <https://embed.widencdn.net/pdf/plus/ssttoolbox/zaotgvw9xp/F-C-22TWHPT18-R.pdf?u=cjmyin>

40. <http://seagrant.soest.hawaii.edu/wp-content/uploads/2018/05/2009-Post-and-Pier-Structural-Seismic-Retrofits.pdf>
41. <http://seagrant.soest.hawaii.edu/wp-content/uploads/2019/04/ii-Post-and-Pier-Retrofit-Demonstration-April-4-2019.pdf>
42. <http://seagrant.soest.hawaii.edu/wp-content/uploads/2018/07/Post-and-Pier-Retrofit-Pearl-City-Final-Report-Evaluation-and-Assessment.pdf>
43. [https://drive.google.com/file/d/1ZCznomGnzQiDH5qSubZsD23NVzK3B5J\\_/view](https://drive.google.com/file/d/1ZCznomGnzQiDH5qSubZsD23NVzK3B5J_/view)
44. <http://seagrant.soest.hawaii.edu/wp-content/uploads/2019/04/Structural-Screw-Retrofit-Demonstration-April-4-2019.pdf>
45. [https://www.youtube.com/attribution\\_link?a=oZZTEvLIqyFpo8B8&u=/watch%3Fv%3D\\_ZoYVzyKefA%26feature%3Dem-uploademail](https://www.youtube.com/attribution_link?a=oZZTEvLIqyFpo8B8&u=/watch%3Fv%3D_ZoYVzyKefA%26feature%3Dem-uploademail)
46. <https://www.youtube.com/watch?v=xXqno7k43HM>
47. <https://www.fema.gov/media-library/assets/documents/13270>
48. <https://vimeo.com/44339612>
49. <http://www.fema.gov/library/viewRecord.do?id=2138>
50. <http://www.fema.gov/library/viewRecord.do?id=3647>
51. <http://www.fema.gov/library/viewRecord.do?id=3263>
52. <https://www.fema.gov/media-library/assets/documents/177700>
53. [https://ags.hawaii.gov/wp-content/uploads/2018/12/Hawaii\\_State\\_Building\\_Code\\_20181113.pdf](https://ags.hawaii.gov/wp-content/uploads/2018/12/Hawaii_State_Building_Code_20181113.pdf) (Appendix U)
54. <http://www.fema.gov/library/viewRecord.do?id=1536>
55. <http://www.fema.gov/library/viewRecord.do?id=1657>
56. <https://view.hawaiianelectric.com/planting-the-right-tree-in-the-right-place/page/1>
57. <http://www.fema.gov/library/viewRecord.do?id=2103>
58. <http://www.strongtie.com/literature/f-plans.html>
59. <https://www.fema.gov/media-library/assets/documents/13237>
60. <https://www.fema.gov/media-library/assets/documents/3293>

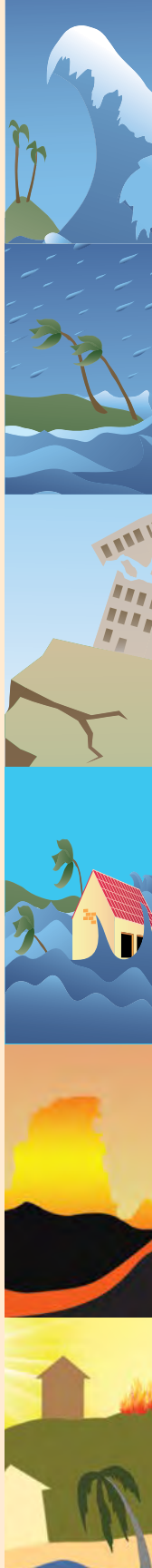



61. <https://www.fema.gov/media-library/assets/documents/6131>
62. <https://www.fema.gov/media-library/assets/documents/480>
63. <https://www.fema.gov/media-library/assets/documents/13261>
64. [https://www.fema.gov/media-library-data/1528734155205-5dba7257256260a5785db8bf7a63243e/Protect\\_Your\\_Home\\_From\\_Flooding\\_Brochure.pdf](https://www.fema.gov/media-library-data/1528734155205-5dba7257256260a5785db8bf7a63243e/Protect_Your_Home_From_Flooding_Brochure.pdf)
65. <http://www.hawaiiwildfire.org/fire-resource-library-blog/rsg-your-personal-wildland-fire-action-guide>
66. <https://view.hawaiianelectric.com/planting-the-right-tree-in-the-right-place/page/1>
67. <https://www.hawaiianelectric.com/safety-and-outages/storm-center/emergency-preparedness-handbook>
68. <https://www.hawaiianelectric.com/products-and-services/save-energy-and-money/energy-savings-toolkits>
69. [http://www.fpl.com/storm/generator\\_safety.shtml](http://www.fpl.com/storm/generator_safety.shtml)
70. <http://health.hawaii.gov/san/food-safety-reference-card/>
71. <http://cca.hawaii.gov/rico/licensedcontractor/>
72. <http://www.honolulu.gov/dem/resources/disaster-supplies-services>
73. <http://files.hawaii.gov/dcca/rico/licensedcontractor/checklist.pdf>
74. <https://www.resilientoahu.org/>
75. <https://www.hawaiianelectric.com/products-and-services/save-energy-and-money/energy-savings-toolkits>
76. <https://www.hawaiidws.org/conservation-resources/>
77. <https://ndptc.hawaii.edu/training/catalog>
78. <https://www.fema.gov/building-science>
79. <https://www.fema.gov/media-library/assets/documents/23781>
80. <http://dod.hawaii.gov/hiema/resources/hharp/>
81. <http://www.hawaiicounty.gov/civil-defense-cert>
82. <https://www.mauicounty.gov/1899/Community-Emergency-Response-Team>

83. <http://www.honolulu.gov/dem/involved/get-trained>
84. <https://www.kauai.gov/CERT>
85. <http://health.hawaii.gov/irhb/files/2013/06/How-to-Remove-Mold-Revised-10-2004.pdf>
86. <https://www.epa.gov/indoor-air-quality-iaq>
87. <http://www.cdc.gov/mold/cleanup.htm>
88. [https://www.fema.gov/media-library-data/1528734155205-5dba7257256260a5785db8bf7a63243e/Protect\\_Your\\_Home\\_From\\_Flooding\\_Brochure.pdf](https://www.fema.gov/media-library-data/1528734155205-5dba7257256260a5785db8bf7a63243e/Protect_Your_Home_From_Flooding_Brochure.pdf)
89. [https://www.fema.gov/media-library-data/20130726-1502-20490-4764/fema\\_tb\\_2\\_rev1.pdf](https://www.fema.gov/media-library-data/20130726-1502-20490-4764/fema_tb_2_rev1.pdf)
90. <https://www.epa.gov/ground-water-and-drinking-water/septic-systems-what-do-after-flood>

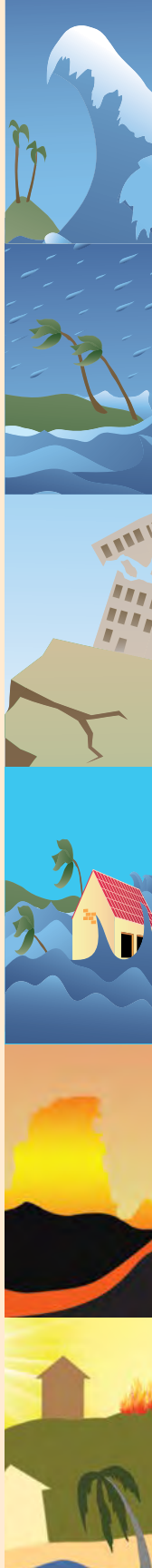



## Endnotes

<sup>1</sup> Fletcher, C.H., Grossman, E.E., Richmond, B.M., and Gibbs, A.E. (2002) **Atlas of Natural Hazards in the Hawaiian Coastal Zone**: U.S. Geological Survey Geological Investigations Series 1-2761, 182p.

<sup>2</sup> Based on data from the former Office of Emergency Permitting, Kaua‘i County. This is based on the reconstruction and building permit database.

<sup>3</sup> Figures from the Federal Emergency Management Agency (FEMA). *Honolulu Star Bulletin* 8 September 2002.

<sup>4</sup> Based on the number of single family homes on each island. From the *Hazard Mitigation Study for the Hawai‘i Hurricane Relief Fund* 7 December 2001. See also Center for Development Studies, Social Science Research Institute, University of Hawai‘i. 1993. Hawai‘i Coastal Hazard Mitigation Planning Project.

<sup>5</sup> Report by U.S. Army Corps of Engineers, Pacific Ocean Division, “Hurricane Iniki—Coastal Inundation, September 11, 1992.”

<sup>6</sup> UNESCO-IOC, *Tsunami, The Great Waves*. IOC Brochure 2006-2. (Paris, UNESCO, 2006.)

<sup>7</sup> During the 1946 tsunami, the water also inundated several thousand feet inland at Kahuku on the north shore of O‘ahu. On December 26, 2004, a tsunami generated from a magnitude 9.3 earthquake in the Indian Ocean resulted in the deaths of over 200,000 citizens in over eleven countries. In Indonesia, the tsunami inundated an area several miles inland. The December 26, 2004, tsunami in the Indian Ocean is thought by many scientists to be a very rare event (time interval between a return event is greater than once every two hundred years) and outside the realm of local historical experience.

<sup>8</sup> See note 1.

<sup>9</sup> Data from Hawai‘i Emergency Management Agency (formerly State Civil Defense) on March 24, 2011. The tsunami generated by the February 27, 2010 earthquake in Chile did not cause significant damage in this state, although small tsunami waves did reach the islands.

<sup>10</sup> It used to take about 30 minutes, but advances in science and increased monitoring have cut the time needed to analyze potentially damaging earthquakes.

<sup>11</sup> To see the entire guideline, go to [http://www.typhoon2000.ph/tropical\\_SS.htm](http://www.typhoon2000.ph/tropical_SS.htm)

<sup>12</sup> Interview with Gary Chock of Martin & Chock Inc, Structural Engineering Firm.



<sup>13</sup> This kit was developed pursuant to Hawai‘i Special Session 2005—Act 5. It appears in “Report of Recommended Statewide Public Hurricane Shelter Criteria, Hurricane Shelter Criteria Committee, State Civil Defense.”

<sup>14</sup> See the poster – Tsunamis in Hawai‘i – Daniel Walker.

<sup>15</sup> Dudley, W.C., Whitney, R., Faasisila, J., Fonolua, S., Jowitt, A., Chan-Kau, M. (2011) Learning from the victims: New physical and social science information about tsunamis from victims of the September 29, 2010 event in Samoa and American Samoa, *Earth-Science Rev.*, 107(1-2):201-206, doi:10.1016/j.earscirev.2011.03.005.

<sup>16</sup> Adapted from the Hawai‘i County Civil Defense Guide on Hurricane Preparedness.

<sup>17</sup> These maps were created at the offices of Martin & Chock, Inc.

<sup>18</sup> See also: “Handbook for Emergency Preparedness,” published by Hawaiian Electric Company, Maui Electric Company, and Hawai‘i Electric Light Company. <https://www.hawaiianelectric.com/safety-and-outages/storm-center/emergency-preparedness-handbook>

<sup>19</sup> [https://www.usgs.gov/faqs/what-should-i-do-during-earthquake?qt-news\\_science\\_products=0#qt-news\\_science\\_products](https://www.usgs.gov/faqs/what-should-i-do-during-earthquake?qt-news_science_products=0#qt-news_science_products)

<sup>20</sup> See note 2.

<sup>21</sup> From “Building Performance: Hurricane Iniki in Hawai‘i—Observations, Recommendations, and Technical Guidance” from the FEMA Federal Insurance Administration, in cooperation with the State of Hawai‘i Civil Defense and Kaua‘i County. January 1993.

<sup>22</sup> Interview with Frank Truitt, building inspector for the Rockport Building Department during assessment of damaged homes in preparation of the Mitigation Assessment Team Report for Hurricane Harvey, FEMA Building Science Branch. See also: (<https://www.fema.gov/media-library/assets/documents/177700>).

<sup>23</sup> The former State of Hawai‘i Loss Mitigation Grant Program recognized that installing hurricane clips was something that a homeowner could do as a “do-it-yourself project.” However, a licensed structural engineer or architect should be consulted to provide initial guidance on the correct clip and fasteners. Each house is a little different.

<sup>24</sup> Robertson and G. Chock, *Structural Seismic Retrofits For Hawai‘i Single Family Residences with Post and Pier Foundations, Volume 1, Results of Study, Structural Analysis, and Retrofit Strategies*. Federal Emergency Management Agency Grant Program – DR-1664-HI.

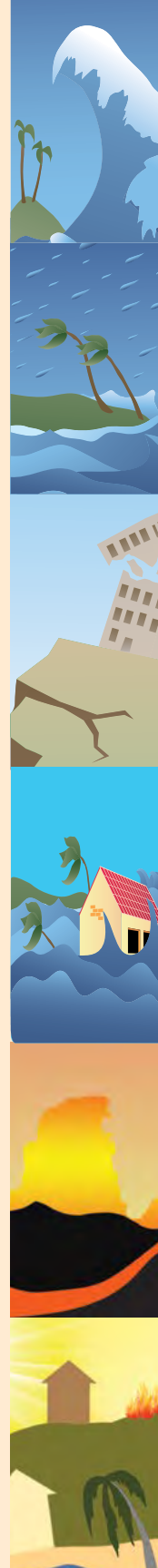

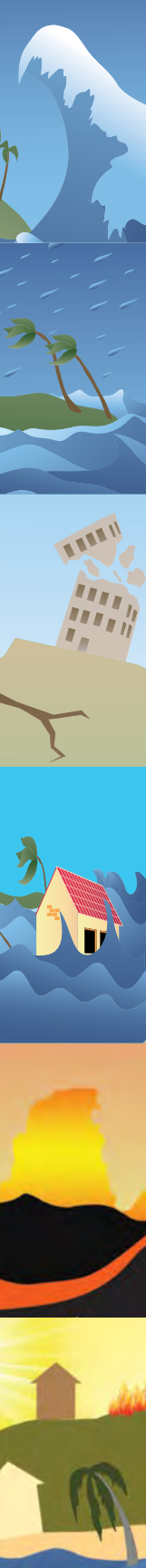

<sup>25</sup> Links are available together on the main webpage for the Homeowner’s Handbook to Prepare for Natural Hazards at: (<http://seagrant.soest.hawaii.edu/homeowners-handbook-to-prepare-for-natural-hazards/>).

<sup>26</sup> Institute for Business and Home Safety. 1998. *Is Your Home Protected from Hurricane Disaster?—A Homeowner’s Guide to Retrofit*

<sup>27</sup> State of Hawai‘i Department of Commerce and Consumer Affairs, <https://cca.hawaii.gov/ins/files/2016/01/Guide-to-Hurricane-Strengthening-of-Hawaii-Single-Family-Residences-Jan-2016.pdf>

<sup>28</sup> Interview with Thomas Smith, AIA, RRC, F.SEI of TlSmith Consulting Inc.

<sup>29</sup> Chapter 11 of the FEMA Coastal Construction Manual (2011) at: <http://www.fema.gov/media-library/assets/documents/3293?id=1671>; FEMA Harvey Mitigation Assessment Team Report (P-2022, 2019) at: (<https://www.fema.gov/media-library/assets/documents/177700>) and the FEMA Home Builder’s Guide to Coastal Construction (P-499, 2010 update) at: <http://www.fema.gov/media-library/assets/documents/6131?id=2138> which contain Technical Fact Sheet No.’s 7.1 for Roof Sheathing, 7.2 for Underlayments, 7.3 for Asphalt Shingle Roofs, 7.4 for Tile Roofing, 7.5 for Roof Vents, and 7.6 for Metal Roof Systems. See also: Hawaii DCCA “Guide to Hurricane Strengthening of Hawaii Single Family Residences”(endnote 27); Insurance Institute for Business and Home Safety “IBHS” at: <https://ibhs.org/wind-driven-rain/hurricane-resources/>; and the Florida Disaster Organization at: ([https://apps.floridadisaster.org/hrg/content/roofs/roofs\\_index.asp](https://apps.floridadisaster.org/hrg/content/roofs/roofs_index.asp)). The demonstration project is also documented at the West Oahu Roofing website: ([http://westoahuroofing.com/?page\\_id=861](http://westoahuroofing.com/?page_id=861)).

<sup>30</sup> From “Against the Wind—Protecting Your Home from Hurricane Wind Damage,” by American Red Cross, FEMA, Home Depot, National Institute of Home Builders, and Georgia Emergency Management Agency (<https://www.fema.gov/media-library/assets/documents/2988>).

<sup>31</sup> <https://www.fema.gov/media-library/assets/documents/13270>

<sup>32</sup> An installer should be able to provide documents on determining wind loads and roof zones to meet ASCE 7 wind load standards and local building codes for the materials on the roof. An example is provided for one type of solar mount commonly used which shows how the roof zones and mount spacing is determined See: ([https://unirac.com/wp-content/uploads/pdf/12\\_SF-INSTALLATION-MANUAL\\_12.pdf](https://unirac.com/wp-content/uploads/pdf/12_SF-INSTALLATION-MANUAL_12.pdf)). Note the size of the buffer zones will depend on the dimensions of the house (height and width) and the roof configuration.

<sup>33</sup> For more information – see ASTM-E1038-10 – Standard Test Method for Determining Resistance of Photovoltaic Modules to Hail with Propelled Ice Balls.

<sup>34</sup> ASTM E2766-13 – Standard Practice for installation of Photovoltaic Arrays on Steep Slope Roofs.

<sup>35</sup> Wind loads for seismic panels have been proposed by the Structural Engineers Association of Hawai‘i (SEAOH). See Guide to the Wind Design Provisions of the Hawai‘i State Building Code, by Gary Chock, available from Hawai‘i Emergency Management Agency. Use for the interior roof zone: Force = 40 x (Area of Panel) (Velocity Eff./105)<sup>2</sup> where Velocity Effective is from the wind maps <http://ags.hawaii.gov/bcc/building-code-rules/>. The wind maps are readily available and easy to look up for an area of interest (See: <https://cca.hawaii.gov/ins/files/2016/01/Guide-to-Hurricane-Strengthening-of-Hawaii-Single-Family-Residences-Jan-2016.pdf> - pages 25, 79-85). As an example, a panel of 41” x 61” is 3.41’ x 5.08’ or has a surface area of 17.32 square feet. For Mānoa, O‘ahu – Veffective is between the 110 and 120 contours, or by using interpolation 115 mph. The Force = 40(17.32) (115/105)<sup>2</sup> = 831 pounds (formula provides answer in pounds). Compare this with the ASTM E2766-13 recommendation for the mounting system to resist at least 30 psf. Given a panel of 17.32 sq.ft., the mounting system should resist at least 519.6 lbs. This compares with the SEAOH recommendation of 831 lbs. These are the wind loads for the 17.32 sq. ft. panel for certain parts of Mānoa. The loads will be higher further into the valley (see wind map). The loads also differ on where the panels are placed on the roof. If the panels are located near the edge, and in particular the corners, see Figure 4-58 and Endnote 32, the pressures are much greater (up to 2.8 times greater). Thus SEAOH recommends the following formula: Force = 100 (17.32)(115/105)<sup>2</sup>. This gives a SEAOH recommended load to resist of 2,077 lbs. This is one of the reasons that it is better to locate panels away from the edges and corners of the house and in the internal portion of the roof, if possible, as noted above. If panels must be build at the edges, corners, or ridges for some houses, consider an increased number of fasteners, or wider and/or longer lag bolts, given the geographical location. This may be especially important at a ridge or high wind area (see wind map for the location of interest). Finally, the contractor should be able to provide testing data from the racking system they will use. The fasteners should have pull out tests which exceed the wind loads of at least 519.6 lbs., preferably 831 lbs., or 2,077 lbs. per panel if near the corner of the roof for a typical house in Mānoa. This should factor in the pull out strength of the fasteners and the number of fasteners per panel. For the house in Figure 4-73 using 3/8 diameter lag bolts and 2.5 inches of penetration, 750 lbs. per fastener was used as a planning guideline with a safety factor. There are many documents online that cover pull out strength of lag screws in Douglas Fir, as well as other wood types.

<sup>36</sup> See the Florida Disaster Organization website on Openings (Windows and Doors) ([https://apps.floridadisaster.org/hrg/content/openings/openings\\_index.asp#Hinged Exterior Doors](https://apps.floridadisaster.org/hrg/content/openings/openings_index.asp#Hinged%20Exterior%20Doors)).





<sup>37</sup> From “Protect Your Property from High Winds,” by FEMA at: <https://www.fema.gov/media-library/assets/documents/13270>.



<sup>38</sup> Watts are equal to the voltage (usually 110 to 120) times the amps. Amp meters can measure in watts or amps and provide information on the running and startup power needs of an appliance in a digital readout.



<sup>39</sup> During a power outage, refrigerators will lose temperature in 4 hours, and a full freezer in 48 hours if the doors are not opened. Many internet sources recommend running a generator to power the refrigerator on a cycle of 1 hour on for every 4 hours. Thus the generator would need to run 6 one hour periods a day. A fuel efficient 2,200 watt generator can run 4-5 hours on a gallon of gas at full capacity and 9-10 hours at quarter power. A gallon of gas would then last almost a day and a half because it can run the efficient Energy Star refrigerator at quarter power. A typical Energy Star refrigerator needs 1,200 watts to start up and 200 watts to run. See also: Tips from Florida Power and Light on running your refrigerator with a generator. [http://www.fpl.com/storm/generator\\_safety.shtml](http://www.fpl.com/storm/generator_safety.shtml)



# Notes

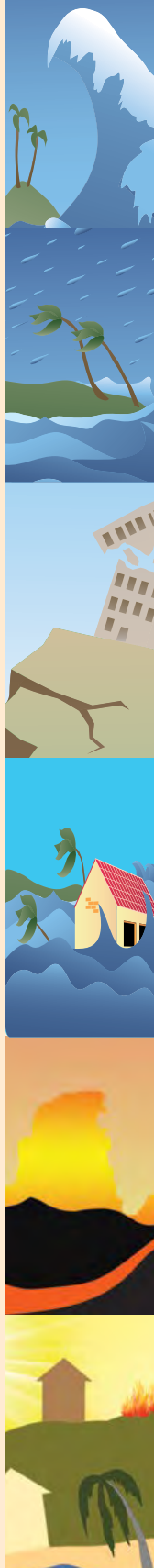



The University of Hawai‘i Sea Grant College Program (Hawai‘i Sea Grant) supports an innovative program of research, education and extension services directed toward the improved understanding and stewardship of coastal and marine resources of the State of Hawai‘i, region, and nation. A searchable database of publications from the national Sea Grant network, comprised of 32 university-based programs, is available at the National Sea Grant Library website: <http://nsgl.gso.uri.edu>.



This book is funded in part by a grant/cooperative agreement from the National Oceanic and Atmospheric Administration, Project A/AS-1, which is sponsored by the University of Hawai‘i Sea Grant College Program, SOEST, under Institutional Grant No. NA18OAR4170076 from NOAA Office of Sea Grant, Department of Commerce. The views expressed herein are those of the author(s) and do not necessarily reflect the views of NOAA or any of its subagencies.



UNIHI-SEAGRANT-BB-19-01.



Fourth edition, version 4.0 published by Hawai‘i Sea Grant, 2019  
Third edition, version 3.2 published by Hawai‘i Sea Grant, 2018  
Third edition, version 3.1 published by Hawai‘i Sea Grant, 2014  
Second edition, version 2.2 published by Hawai‘i Sea Grant, 2013  
Second edition, version 2.1 published by Hawai‘i Sea Grant, 2011  
First edition, version 1.1 published by Hawai‘i Sea Grant, 2007



Printed in South Korea



## Additional Hawai'i Sea Grant resources:



### *Hawai'i Coastal Hazard Mitigation Guidebook*

Written for a wide and varied audience including planners, architects, homeowners and government agencies, the guidebook covers how to mitigate the risks associated with coastal hazards during the development process. Emphasis is placed on early planning to address where to build as well as how to build, specifically addressing coastal and bluff erosion, sea-level rise, flooding, tsunamis, and hurricanes.



### *Hawai'i Sea Level Rise Viewer*

[www.hawaiiisealevelriseviewer.org](http://www.hawaiiisealevelriseviewer.org)

Across the Hawaiian Islands vulnerability to coastal hazards is increasing with climate change and sea level rise and as development along our shorelines continues to expand. Access to high-resolution local hazard exposure and vulnerability data and maps is critical for communities to understand and plan for

increased coastal flooding and erosion with sea level rise. The Hawai'i Sea Level Rise Viewer serves as an online interactive atlas accompanying the Hawai'i Sea Level Rise Vulnerability and Adaptation Report, completed in December 2017. The report and map data in the viewer incorporates the best-available science on sea level rise and potential impacts. Explore the Hawai'i Climate Adaptation Portal and view the report at: <http://climateadaptation.hawaii.gov>

University of Hawai'i Sea Grant College Program

2525 Correa Road, HIG 208

Honolulu, HI 96822

Phone: (808) 956-7410

Email: [uhsgcomm@hawaii.edu](mailto:uhsgcomm@hawaii.edu)

Web: <http://hawaiiiseagrant.org>

# Resilient - Adaptive - Sustainable



TSUNAMIS



HURRICANES



EARTHQUAKES



FLOODS



VOLCANO



CLIMATE CHANGE

