



8,000 | 10,000 | 12,000

EN

OWNER'S AND OPERATOR'S MANUAL



novawinch.com | info@novawinch.com
Novawinch US, Inc.
Mesa, AZ USA
(475) 522-0774

Zhejiang NOWVOW Mechanical & Electrical Corp., LTD
1689 Xianyan Road, Jinhua, Zhejiang, China



novawinch.com | info@novawinch.com

WARRANTY INFORMATION

Novawinch proudly builds winches to withstand just about anything you can throw at it.

Our warranty varies from geographic region to region. Please contact your retailer for warranty information.

In all cases, it's important to keep the following in mind:

- Our warranty is limited and we reserve the right to repair/replace product based on our findings/preference.
- Our warranty does not apply to rope (steel cable or synthetic) and does not apply to the finish of the winch or components.
- Novawinch will not be liable for any fees, costs or charges associated from the removal, installation, transport to an authorized service center or other incurred.
- Our warranty excludes: any winch modification, damage from water or corrosion, or if used in inappropriate applications including commercial.

Register now!

Quickly and easily register your Novawinch now online at <https://novawinch.com/register> or scan the QR Code.



We believe you don't have to cut corners to build a high-performance yet affordable winch.

As proof of this belief, we present you with Stinger.

With proper care and maintenance your new Stinger should provide a long service life.

It is imperative that you read and understand this manual - your safety, those around you and your winch, all depend on this. Don't let us down.

Welcome to the Novawinch family.



TABLE OF CONTENTS

Warnings and Safety 01

Winching Best Practices 02

Installation 03---06

Accessories 07

Winching Procedures 08---13

Maintenance 14

Troubleshooting 15

Specifications 16---17

Parts List 18---21

Warranty 22

Register now!

Quickly and easily register your Novawinch now online at <https://novawinch.com/register> or scan the QR Code.



Stinger+ 8000, 10000, 12000 Synthetic Rope		
ASSEMBLY	ITEM	DESCRIPTION
Electric Motor Assembly	1	Motor Assembly
	2	Seal Ring
	3	Slid Bearing
Tie Bar Assembly	11	Tie Bar
	12	Tie Bar
	9	Hexagon Socket Cap Screws M6x40
	14	Hexagon Socket Button Head Screw M8x25
	10	Washer Ø6, Locking
	34	Washer Ø6, Flat
	13	Washer Ø8, Locking
	15	Washer Ø8, Flat
	35	Spring Washer 6
	Coupling Assembly	4
5		Hexagon Shaft #1
Drum Assembly	6	Drum
	7	Brake Coupling
	8	Brake Assembly
Gearbox Assembly	2	Seal Ring
	3	Slid Bearing
	16	Hexagon Shaft #2
	17	Hexagon Socket Cap Screws M5x25
	18	Washer Ø5, Locking
	19	Gear Box Frame
	20	Seal #1
	21	3rd Stage Gear Ring
	22	Retaining Ring 105
	24	3rd Stage Planetary Gear Assembly
	25	Rub Reduce Washer #1
	26	2 nd Stage Planetary Gear Assembly
	27	Rub Reduce Washer #2
	28	1 st Stage Planetary Gear Assembly
	29	1 st Stage Sun Gear
	30	1 st & 2 nd Gear Ring
	31	Rub Reduce Washer #1
	32	Slide Bearing
33	Gear Box Body	
34	Washer Ø6, Flat	

Stinger+ 8000, 10000, 12000 Synthetic Rope		
ASSEMBLY	ITEM	DESCRIPTION
Gearbox Assembly	10	Washer Ø6, Locking
	35	Hexagon Socket Cap Screws M6x25
	36	O-Ring 19*1.8
	37	Rub Reduce Shaft #2
	38	Clutch
	39	Hexagon Socket Button Head Screw M4x10
	40	Washer Ø4, Locking
	50	Screw M8x8
Control Box	46	Control Box
	47	Circuit Breaker
	48	Hexagon Socket Cap Screws M5x20
	18	Washer Ø5, Locking
Accessories	49	Washer Ø5, Flat
	41	Synthetic rope
	42	Hook
	43	Hand Saver
	45	Hawse Fairlead
	45	Hardware
	44	Remote Control Cable
51	Wireless Handheld Control	

Note: This diagram and parts list is for 8000, 10000 and 12000 capacity Stinger winches.
The parts specification are different for 8000, 10000, 12000; please contact Novawinch for spare/replacement parts detail.

Stinger+ Parts, Exploded Diagram

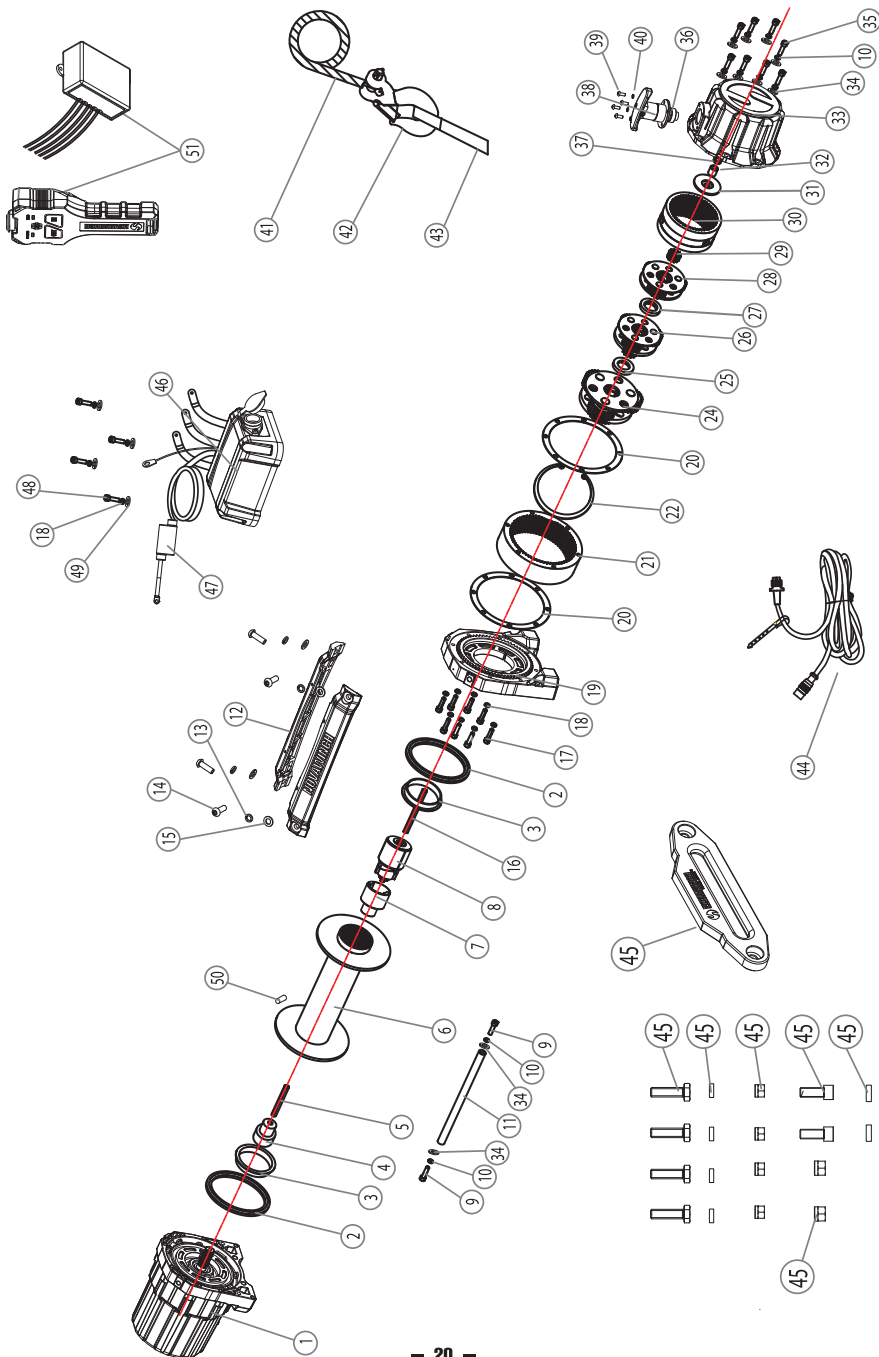

Warnings and Safety

The responsibility for safe installation and operation of this product ultimately rests with you, the operator. Read and understand all safety precautions and operating instructions before installing and operating your product. Careless operation can result in serious injury and/or property damage.

Throughout this manual you will find these warnings:



Indicates an imminently hazardous situation which, if not avoided, will result in death or serious injury.



Indicates a potentially hazardous situation which, if not avoided, could result in death or serious injury.



Indicates a potentially hazardous situation which, if not avoided, may result in minor or moderate injury. This notation is also used to alert against unsafe practices.

These symbols are used on your winch and in this manual:



1. Before use, read this manual and ensure that you are familiar with all winching operations (winch speeds & direction). We strongly recommend that prior to using this product, intended users undertake off road training that includes winch operation.
2. Winch operator must be alert and not under the influence of drugs, alcohol or medications.
3. Stand clear of wire and load during winching. Keep all others at a safe distance. If a winching rope pulls loose or breaks under load, it can lash back with dangerous force.
4. Do not grab hook with hand, use the included handsaver strap instead. Always use appropriate gloves when handling the rope.
5. Only use correctly rated rope. Inspect for damage and/or defects before use.
6. Do not use an unsuitable hook or snatch block for rope.
7. The operator must remain with the winch during operation.
8. The winch duty rating is S3 (intermittent-periodic).
9. Do not use the winch as a lifting device or a hoist for vertical lifting and moving people.
10. Ensure that the winch is connected to the correct voltage (12VDC only).
11. Do not exceed the maximum line pull ratings shown in this manual. Shock loads must not exceed these ratings and should be avoided.

Winching Best Practices

- We strongly recommend that prior to using this product, intended users undertake off road training that includes winch operation. Recovering disabled vehicles is a potentially dangerous undertaking with or without winch operation.
- This winch (like all others) is rated based on the first layer of rope/cable on the drum for intermittent, periodic duty.
- Rope/cable can break without warning. Always keep a safe distance from the winch and rope while under load.
- Failure to adequately align, support or attach the winch to a suitable mounting base could result in reduced performance, damage the winch, rope and mounting platform.

Duty Cycle Ratings

Duty Cycle Ratings typically specify continuous, intermittent, or special duty (typically expressed in minutes). The IEC (International Electrotechnical Commission) lists the following ratings:

- **S1 - Continuous duty**
 - The motor works at a constant load for enough time to reach temperature equilibrium.
- **S2 - Short-time duty**
 - The motor works at a constant load, but not long enough to reach temperature equilibrium, and the rest periods are long enough for the motor to reach ambient temperature.
- **S3 - Intermittent periodic duty**
 - Sequential, identical run and rest cycles with constant load. Temperature equilibrium is never reached. Starting current has little effect on temperature rise.

All automotive winches are rated at S3 intermittent periodic duty.

Stinger 8000, 10000, 12000 Wire rope		
ASSEMBLY	ITEM	DESCRIPTION
Electric Motor Assembly	1	Motor Assembly
	2	Seal Ring
	3	Slid Bearing
Tie Bar Assembly	11	Tie Bar
	12	Tie Bar
	9	Hexagon Socket Cap Screws M6x40
	14	Hexagon Socket Button Head Screw M8x25
	10	Washer Ø6, Locking
	34	Washer Ø6, Flat
	13	Washer Ø8, Locking
	15	Washer Ø8, Flat
	35	Spring Washer 6
	Coupling Assembly	4
5		Hexagon Shaft #1
Drum Assembly	6	Drum
	7	Brake Coupling
	8	Brake Assembly
Gearbox Assembly	2	Seal Ring
	3	Slid Bearing
	16	Hexagon Shaft #2
	17	Hexagon Socket Cap Screws M5x25
	18	Washer Ø5, Locking
	19	Gear Box Frame
	20	Seal #1
	21	3rd Stage Gear Ring
	22	Retaining Ring 105
	24	3rd Stage Planetary Gear Assembly
	25	Rub Reduce Washer #1
	26	2nd Stage Planetary Gear Assembly
	27	Rub Reduce Washer #2
	28	1st Stage Planetary Gear Assembly
	29	1st Stage Sun Gear
	30	1st & 2nd Gear Ring
	31	Rub Reduce Washer #1
	32	Slide Bearing
33	Gear Box Body	
34	Washer Ø6, Flat	

Stinger 8000, 10000, 12000 Wire rope		
ASSEMBLY	ITEM	DESCRIPTION
Gearbox Assembly	10	Washer Ø6, Locking
	35	Hexagon Socket Cap Screws M6x25
	36	O-Ring 19*1.8
	37	Rub Reduce Shaft #2
	38	Clutch
	39	Hexagon Socket Button Head Screw M4x10
	40	Washer Ø4, Locking
	50	Screw M8x8
Control Box	46	Control Box
	47	Circuit Breaker
	48	Hexagon Socket Cap Screws M5x20
	18	Washer Ø5, Locking
	49	Washer Ø5, Flat
Accessories	41	Wire rope
	42	Hook
	43	Hand Saver
	45	Roller Fairlead
	45	Hardware
	44	Switch

Note: This diagram and parts list is for 8000, 10000 and 12000 capacity Stinger winches.

The parts specification are different for 8000, 10000, 12000; please contact Novawinch for spare/replacement parts detail.

Stinger Parts, Exploded Diagram

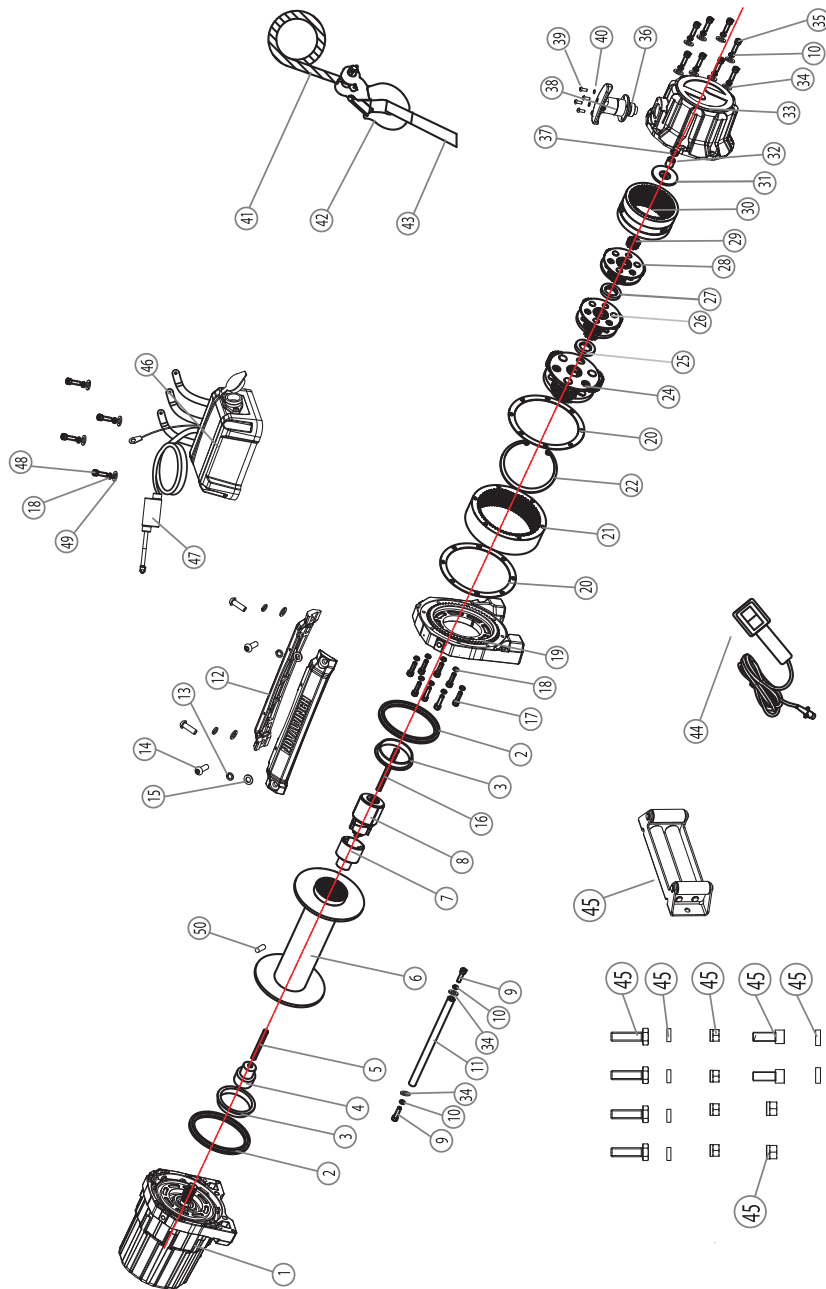

Installation

It is highly recommended that installation of this product is performed by an experienced technician.

Winch Mounting



WARNING

Be sure that both the mounting plate and winch hardware have been properly tightened.



CAUTION

No part of the vehicle (skid plates, wiring, auxiliary lighting, tires, etc.) should impede the operation of your Novawinch. When mounting, check all vehicle and winch parts for free operation. Be sure that the winch mounting location does not significantly reduce ground clearance.

1. Choose a winch plate or bumper that allows installation on a flat and hard surface or mounting channel to ensure the motor, drum and gearbox housing are aligned correctly.
2. The fairlead is not designed to mount to the winch directly.
3. The rope must be wound in an under-wound orientation only.

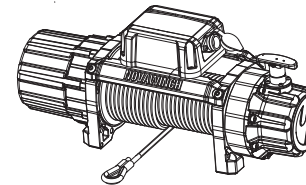

Underwound (correct)

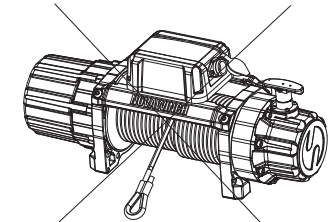

Overwound (incorrect)

Installation Variations:

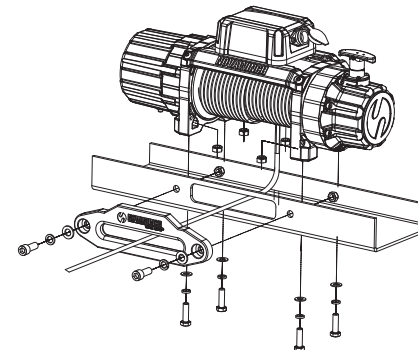

Foot-down Installation

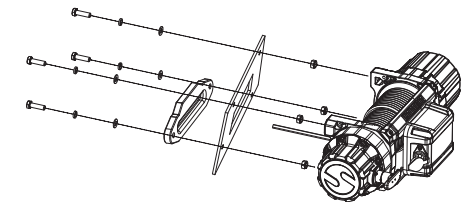

Foot-forward Installation

The winch is provided with a range of bolts to suit the different mounting options:

- 4 x M10x35mm Hex Head bolts (for foot down installation)
- 2 x M10x50mm Button Head Bolts (for mounting Hawse Fairlead in foot forward mounting – Stinger 10 and 12)
- 2 x M10x45mm Button Head Bolts (for mounting Roller Fairlead in foot forward mounting – Stinger 10 only)
- 2 x M10x40mm Button Head Bolts (for mounting Hawse & Roller Fairlead in foot down mounting) 6 x M10 Spring Washers
- 6 x M10 Flat Washers
- 4 x M10 Hex Nuts
- 2 x M10 Lock Nuts

Note: Four (4) M10 x 1.50 pitch 8.8 grade high tensile steel bolts (supplied) must be used in order to sustain the loads imposed on the winch mounting.



WARNING

If different length bolts, nuts, washers and other hardware are required for your installation, ensure they equal or exceed the strength grade of the supplied hardware. In no circumstances should the end of the mounting bolts touch the inside surface of the casting mount pockets.

Torque Settings (Maximum) M10 x 1.5 - 8.8 Grade: 44NM

Control Box Mounting

The Control Box has been designed with multiple mounting options to suit a variety of mounting locations and orientations.

Gearbox Rotation

The gearbox end of the winch can be rotated in 45° increments to allow for the clutch handle to be orientated to best suit the installation requirements.

1. Loosen and partially remove the 8 x bolts (see important note and red arrows below) that secure the two gearbox sections to the winch. DO NOT remove the gearbox sections from the winch.
2. Rotate the two gearbox sections and bolts simultaneously (all moving parts highlighted in gray) to achieve the target angle as highlighted below. Ensure the gearbox seal reseats in the correct position.
3. Reinstall and tighten all bolts to 6Nm with torque wrench.

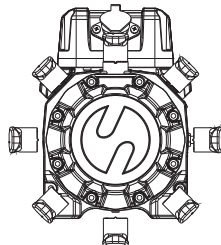
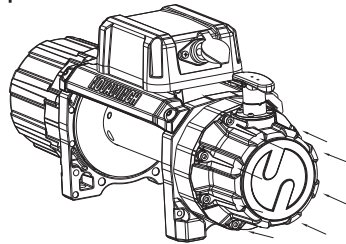

Specifications: Stinger+

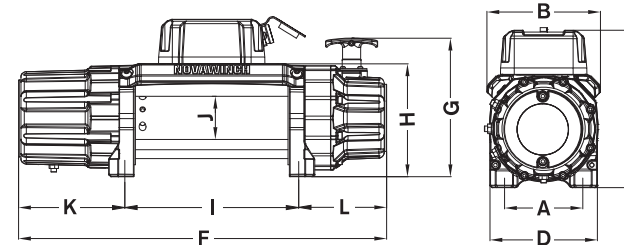

Dimensions	
A	4.50" (114mm)
B	6.53" (166mm)
D	6.18" (157mm)
E	9.05" (230mm)
F	21.25" (540mm)
G	7.95" (202mm)
H	6.49" (165mm)
I	10" (254mm)
J	2.48" (63mm)
K	6.14" (156mm)
L	5.11" (130mm)

Specifications	8000	10000	12000
Rated Line Pull	8000 lbs. (3629 kg)	10000 lbs. (4536 kg)	12000 lbs (5443 kg)
Voltage	12V DC	12V DC	12V DC
Motor	5.6hp (4.2kW)	6.0hp (4.5kW)	7.3hp (5.5kW)
Gear Train	3 Stage Planetary	3 Stage Planetary	3-Stage Planetary
Gear Ratio	196:1	196:1	196:1
Clutch	Pull & Turn	Pull & Turn	Pull & Turn
Braking Action	Mechanical, Auto Load Holding	Mechanical, Auto Load Holding	Mechanical, Auto Load Holding
Synthetic Rope	5/16" x 95' (8.1mm x 29m)	3/8" x 85.3' (9.2mm x 26m)	3/8" x 85.3' (9.2mm x 26m)
Fairlead	Aluminum Hawse	Aluminum Hawse	Aluminum Hawse
Drum Size	2.48" x 8.8" (63mm x 244mm)	2.48" x 8.8" (63mm x 244mm)	2.48" x 8.8" (63mm x 244mm)
Winch Dimensions	21.25" x 6.49" x 9.05" (540x165x230mm)	21.25" x 6.49" x 9.05" (540x165x230mm)	21.25" x 6.49" x 9.05" (540x165x230mm)
Mounting Bolt Pattern	10" x 4.5" (254mm x 114.3mm)	10" x 4.5" (254mm x 114.3mm)	10" x 4.5" (254mm x 114.3mm)
Remote	Wireless/Wired DUO, 12.7' (3.9m)	Wireless/Wired DUO, 12.7' (3.9m)	Wireless/Wired DUO, 12.7' (3.9m)
Net Weight	62.8 lbs (28.5 kgs)	63.5 lbs (28.9 kgs)	63.5 lbs (28.9 kgs)
Gross Weight	67.2 lbs (30.5 kgs)	68.1 lbs (30.9 kgs)	68.1 lbs (30.9 kgs)

Performance 8000				
Line Pull	Line Speed	Current		
Lbs.	kgs	FPM	MPM	Amps
0	0	29.5	9	65
2000	908	13.7	4.2	135
4000	1816	9.5	2.9	195
6000	2721	7.5	2.3	255
8000	3629	6.2	1.9	330

Performance 10000				
Line Pull	Line Speed	Current		
Lbs.	kgs	FPM	MPM	Amps
0	0	29.5	9.5	70
4000	1816	10.1	3.1	200
6000	2721	8.2	2.5	260
8000	3629	6.2	1.9	315
10000	4536	5.2	1.6	380

Performance 12000				
Line Pull	Line Speed	Current		
Lbs.	kgs	FPM	MPM	Amps
0	0	32.8	10	80
4000	1816	10.8	3.3	210
6000	2721	8.8	2.7	270
8000	3629	6.5	2.0	330
10000	4536	5.5	1.7	385
12000	5443	3.6	1.1	420

Specifications: Stinger

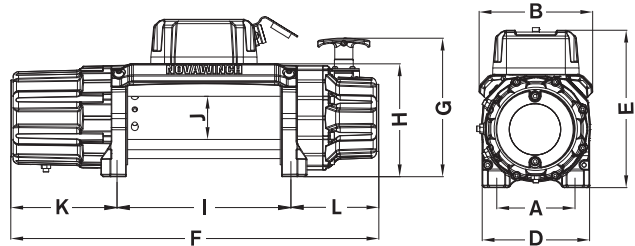

Dimensions	
A	4.50" (114mm)
B	6.53" (166mm)
D	6.18" (157mm)
E	9.05" (230mm)
F	21.25" (540mm)
G	7.95" (202mm)
H	6.49" (165mm)
I	10" (254mm)
J	2.48" (63mm)
K	6.14" (156mm)
L	5.11" (130mm)

Specifications	8000	10000	12000
Rated Line Pull	8000 lbs. (3629 kg)	10000 lbs. (4536 kg)	12000 lbs (5443 kg)
Voltage	12V DC	12V DC	12V DC
Motor	5.6hp (4.2kW)	6.0hp (4.5kW)	7.3hp (5.5kW)
Gear Train	3 Stage Planetary	3 Stage Planetary	3-Stage Planetary
Gear Ratio	196:1	196:1	196:1
Clutch	Pull & Turn	Pull & Turn	Pull & Turn
Braking Action	Mechanical, Auto Load Holding	Mechanical, Auto Load Holding	Mechanical, Auto Load Holding
Wire Rope	5/16" x 95' (8.1mm x 29m)	3/8" x 85.3' (9.2mm x 26m)	3/8" x 85.3' (9.2mm x 26m)
Fairlead	4-Way Roller	4-Way Roller	4-Way Roller
Drum Size	2.48" x 8.8" (63mm x 244mm)	2.48" x 8.8" (63mm x 244mm)	2.48" x 8.8" (63mm x 244mm)
Winch Dimensions	21.25" x 6.49" x 9.05" (540x165x230mm)	21.25" x 6.49" x 9.05" (540x165x230mm)	21.25" x 6.49" x 9.05" (540x165x230mm)
Mounting Bolt Pattern	10" x 4.5" (254mm x 114.3mm)	10" x 4.5" (254mm x 114.3mm)	10" x 4.5" (254mm x 114.3mm)
Remote	Wired, 12.7' (3.9m)	Wired, 12.7' (3.9m)	Wired, 12.7' (3.9m)
Net Weight	84.8 lbs (38.5 kgs)	87.8 lbs (40 kgs)	87.8 lbs (40 kgs)
Gross Weight	89.3 lbs (40.5 kgs)	92.6 lbs (42 kgs)	92.6 lbs (42 kgs)

Performance 8000					
Line Pull		Line Speed		Current	
Lbs.	kgs	FPM	MPM	Amps	
0	0	29.5	9	65	
2000	908	13.7	4.2	135	
4000	1816	9.5	2.9	195	
6000	2721	7.5	2.3	255	
8000	3629	6.2	1.9	330	

Performance 10000					
Line Pull		Line Speed		Current	
Lbs.	kgs	FPM	MPM	Amps	
0	0	29.5	9.5	70	
4000	1816	10.1	3.1	200	
6000	2721	8.2	2.5	260	
8000	3629	6.2	1.9	315	
10000	4536	5.2	1.6	380	

Performance 12000					
Line Pull		Line Speed		Current	
Lbs.	kgs	FPM	MPM	Amps	
0	0	32.8	10	80	
4000	1816	10.8	3.3	210	
6000	2721	8.8	2.7	270	
8000	3629	6.5	2.0	330	
10000	4536	5.5	1.7	385	
12000	5443	3.6	1.1	420	

Note: DO NOT USE power tools such as impact drivers. This may lead to stripping of bolt threads and head of socket head bolt.

Motor Rotation

The motor can be rotated to 4 positions in 90° increments to allow for repositioning of the poles to best suit the installation requirements. These positions are @ 0°, 90° and 180° and 270°.

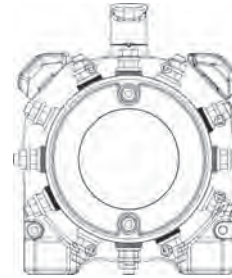

1. Loosen and remove the 6 x bolts that secure the motor cover to the drum support.
2. Remove the motor cover from the winch.
3. Loosen and partially remove the 2 x bolts that secure the motor to the drum support.
4. Rotate the motor to achieve the desired position, ensuring the motor seal reseats into the correct position. Reinstall motor bolts and tighten to 10Nm torque.
5. Reinstall the motor cover and tighten the 6 x bolts to 1.5Nm with torque wrench.

Note: DO NOT USE power tools such as impact drivers. This may lead to stripping of bolt threads and head of socket head bolt.

Battery Recommendations

A fully charged battery and good connections are essential for the proper operation of your winch. The minimum requirement for a 12 Volt DC battery is 650 cold cranking amps.



Before starting your Novawinch installation, disconnect the vehicle ground and positive leads from the battery.

Wiring Diagram

Attach the black lead firmly to the negative (-) battery terminal and red lead to the positive (+) battery terminal. The voltage drop for the winch motor must not exceed 10% of the nominal voltage of 12V. For best performance, mount the winch as close to the battery as possible.

For wiring of the wireless receiver on Stinger + models, a 2m long red power wire with inline fuse exits out of the control box and should be connected to a switched power source. We recommend connection to the vehicles ignition or accessories circuits, which will allow for the wireless to be used only when the vehicle is turned on. Another option is to run it through a dash mounted on/off switch so that the user can turn the wireless function on and off as required.

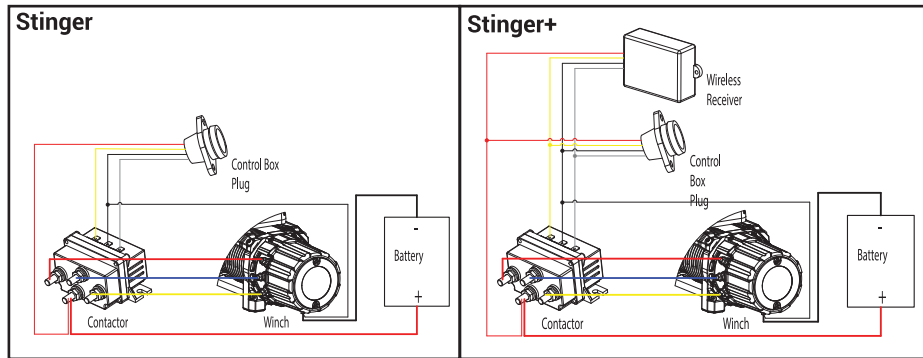

Note: Contactor and motor nuts should be torqued according to the diagram below:

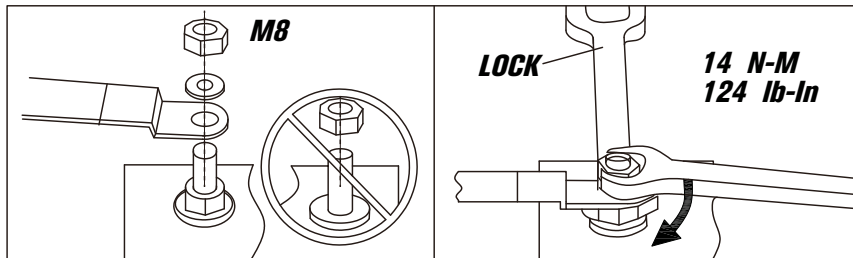

WARNING

Rope Preparation

Prior to using the rope for the first time, it must be tensioned onto the drum under load to ensure a tight and uniform wrap is achieved. A rope that is not tensioned and wound tightly and evenly prior to use can be permanently damaged since the outer layers of rope can draw down into the inner layers leading to binding, pinching or wedging between layers.

One method for tensioning the rope onto the drum is to use the weight of the vehicle on a slight incline to pull on the rope while spooling in. This can be achieved by following the steps outlined in the following section "Winching Procedures" (Page XX). Prior to spooling in under this load, ensure the rope is pulled out to leave the minimum amount of wraps.

Trouble shooting

Symptom	Possible Cause	Remedy
Winch will not operate	Cut circuit	Check battery leads
	Weak battery	Recharge/replace battery
	Bad connection of wires	Reconnect/tighten
	Damaged contactor	Replace contactor
	Cut circuit on switch	Replace switch
	Damaged motor/brushes	Replace motor/brushes
	Faulty motor wiring	Replace wiring
Motor runs in one direction only	Broken wire or bad connection	Reconnect/Replace wiring
	Damaged or stuck contactor	Replace contactor
	Switch inoperative	Replace switch
	Faulty wiring	Replace wiring
Drum will not freespool	Clutch does not disengage	Engage clutch
	Damaged first stage shaft	Replace first stage shaft
	Damaged brake	Replace brake
Brake fails to operate	Gear train is bound	Replace brake
	Damaged brake	Replace brake
	Damaged gear box	Replace brake
	Damaged ratchet	Replace brake
Braking distance is too long	Worn brake	Replace brake
Brake jam	Damaged brake	Replace brake
Damaged gearbox	Externally damaged parts	Replace damaged parts
	Damaged gear train	Replace damaged parts
	Over load operation	Stop winch, reduce load
Motor runs extremely hot	Long period of operation	Allow to cool
	Damaged motor	Replace/repair motor
	Damaged/inoperative brake	Replace/repair brake

Maintenance

Service and repair of this winch should only be carried out by an authorized service center. Unauthorized repairs or service will void warranty.

The winch should be used regularly to ensure components are kept in good working order. At a minimum, it's recommended that the rope is powered out and then powered back in on a monthly basis by following the correct winching procedures. The drum support seals are a wearing item and are critical to retaining the sealed design of the winch. These should be inspected and greased or replaced as required depending on the frequency of use and the operational environment.

All moving parts in the winch are permanently lubricated at the time of assembly. Under normal conditions, factory lubrication will suffice. If lubrication of the gear box is necessary after repair or disassembly, use a water-resistant lithium grease such as Shell EP2 or equivalent grease. The clutch handle can be lubricated regularly with light oil.

Cleaning

Only use low-pressure water and a soapy sponge to clean your winch. If high pressure water is used, do not direct it at the drum area or the clutch handle. Using high pressure water in these areas can force water past seals and lead to winch damage.

Synthetic Rope

1. Periodically check the rope for damage or wear. Frayed, kinked or damaged winch rope must be replaced immediately.
2. When the rope is used for the first time, the outer filaments may fray. This is a result of the out filaments breaking. The roughened surface will actually protect the inner fibers.
3. Inspect both inner and outer fibers. Open the strands and look for powdered fiber. This is a sign of internal wear.
4. Protect your rope from rubbing against sharp or abrasive objects.
5. An aluminum hawse fairlead with rounded edges is recommended for synthetic rope as it resists damage more easily than a roller fairlead.
6. Keep your synthetic rope clean and dry. To clean it after use in muddy conditions, spool out the rope, rinse it with fresh water and let it dry completely before re spooling. Rinsing can be done in a bucket of water with a high degree of success.
7. All synthetic ropes are affected by UV rays, chemicals, abrasion and heat. Once the synthetic rope has begun to deteriorate the breaking strength is compromised. It is recommended that synthetic rope is replaced every 12 months once fitted or UV exposed.

Accessories



Any accessories to be used with your winch should be properly sized and rated. It's imperative to inspect these tools periodically for damage that could reduce their strength.

Snatch Block

A snatch block should be in every recovery bag. Useful to redirect loads it's secret power lies in creating a mechanical advantage of a winch, when a winch line is run out to a block and back to a vehicles anchor point, the pull force becomes 2x (while speed of recovery is halved).

Tree Trunk Protector (tree saver) Strap

A tree trunk protector strap is essential for connecting a rope to almost any anchor point but is primarily designed to prevent damage to trees used as anchor points. The tree trunk protector should be wrapped around the chosen tree or anchor point as low to the ground as possible and the two ends brought together and joined with a shackle. The shackle then becomes the recovery point to where the rope or extension strap is joined.

Recovery Damper

A recovery damper is a safety device designed to help eliminate the possibility of injury or property damage in the event of a rope failure. Placed in the middle third of a live rope, in the event of the rope breaking, the damper can help absorb the energy in the rope and reduce the likelihood of injury or damage.

Winch Extension Strap

Extend your winch's reach with an extension strap. These straps are made from polyester webbing and come in various lengths and load ratings to suit varying recovery situations.

Shackles

Only bow shackles or soft shackles that are load-rated should be used for vehicle recovery. Load ratings are visible on the shackle and will be in the form of WLL (work ing load limit) or SWL (safe working load). The shackles, or any other recovery equipment, used should be sized correctly for the winching task. Pack more than you need.

Gloves

A good pair of gloves are essential for working with steel cable and helpful for handling synthetic rope. You never know who or what you'll run into on the trail and having a pair of gloves at the ready is ideal hand protection.

Find professionally-rated and approved accessories at novawinch.com

Winching Procedures

Important Notes Before Operating the Winch

Clutch Operation

Familiarize yourself with the clutch operation. The clutch handle either “Engages” the winch for operation or “Disengages” the winch for free spooling of the rope. The clutch must always be “Engaged” before operating the winch under power.

1. To disengage, pull and turn the clutch handle 90° in a clockwise direction to the “Disengaged” position. The rope can now free spool off the drum.
2. To engage, pull and turn the clutch handle 90° in a counter-clockwise direction to the “Engaged” position.
3. If the clutch handle cannot be properly locked in the “Engaged” position, rotate the drum to help the clutch device engage the gear train.
4. Wear appropriate gloves and use a pull strap when guiding the rope off the drum.
5. Never disengage the clutch while the rope is under load. The clutch handle must be returned to the “Engaged” position before winching.

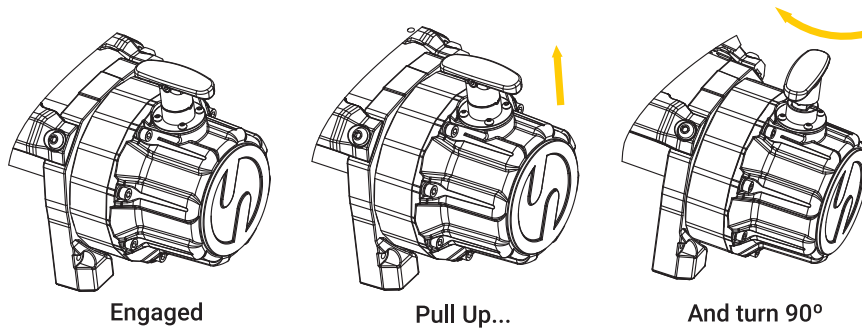

⚠ DANGER

Do not disengage clutch under load. Be certain there is no tension on the rope when you disengage the clutch. Before winching a load, be sure the clutch is fully engaged.

Powering Out (No Load)

The unique Proportional Brake in the Stinger winch allows for effortless powering OUT under NO LOAD, with no concern for damage occurring to the brake or motor. In some circumstances powering out the rope may be quicker and easier than free spooling by hand.

Powering Out (Under Load)

It is not recommended to power OUT the WITH LOAD for longer than 30 seconds. Exceeding this time will cause high amounts of wear and heat to the friction brake.

Safe Winch Operation (continued)

After unspooling the rope and preparing for recovery, run the winch intermittently to take up rope slack. When using a pulley block, be sure the rope is running properly in all pulley rollers before applying a load.

⚠ WARNING

Do not re-engage clutch while winch is running (or anytime drum is spinning).

⚠ WARNING

Always operate winch with an unobstructed view of the winching operation. Never obscure warning and instruction labels.

This illustration is a common rigging technique. A nylon sling (tree saver) is used to protect the tree when it is used as an anchor point. The rope is attached to the strap.

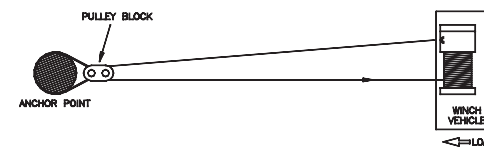

This illustration shows a method of rigging used to obtain a mechanical advantage. The use of a pulley block will almost double pulling capacity.

This illustration shows the use of pulley to redirect the pull. Mechanical advantage can be obtained by attaching a pulley block to the nylon sling with a shackle and running the rope to an anchor point.

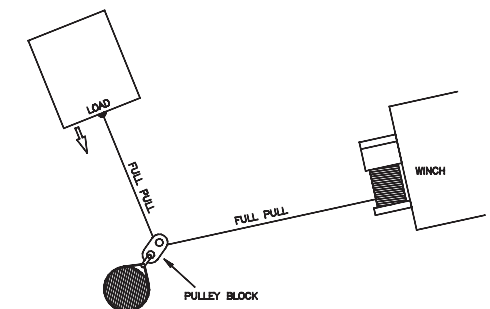

Safe Winch Operation (continued)



Use a pulley block to avoid winching at sharp angles. Uneven layering of winch rope will cause serious damage to both winch and rope. It can be corrected by securing load, spooling out the rope and repositioning it to the opposite end of the drum.



Use the winch to move the load. Do not attempt to assist the winch by moving the vehicle. The combination of the winch and vehicle pulling could overload rope and/or rigging and the load could break the winch/rigging.



Never rely on the winch to hold a load in place. This winch is not designed for load-holding applications and may unwind or fail due to shock-loading. The load should be secured by other means, and the winch hook detached from the load.



Take your time when rigging and include a reasonable factor for safety. Improper rigging can result in damage to vehicle and equipment. It can also cause an injury.



Use a Tree Saver Strap or similar when attaching the rope to an anchor point. Do not run the rope around the anchor and back onto itself - doing so can cause the rope to break or degrade.

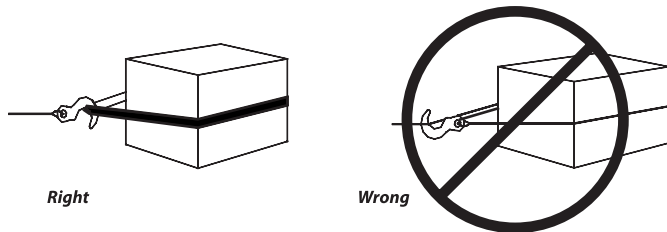

Always use the handsaver. Do not hold the hook with your hand. This is important not only when reeling rope in, but also when removing rope from the winch under power.

DUO Wireless/Wired Controller (Stinger+)

The Stinger+ Winch is controlled by the Novawinch exclusive DUO Wireless/Wired winch remote. Capable of both running on its internal battery as well as through a wired connection to the winch, the DUO is the ultimate in control.

Part Identification



Part List	
1	Handheld Controller
2	Wire Connector (12.7', 3.9m)
3	Wireless Receiver
4	Lanyard (39", 100cm)

Controller Button Layout

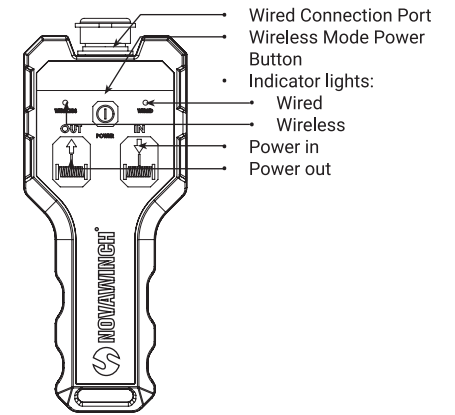

Wired Operation

Connect DUO handheld controller to included Wiring by aligning the 4-pin key, push to connect and tighten the knurled ring for security.

Connect the other end of wiring to the winch solenoid box and screw on safety ring. Once connected, the remote is active.

Wired Operation

- Press and hold the Wireless Mode Power Button for 3 seconds. This is complete when the Wireless indicator light is lit.
- When the Wireless indicator light is active, the remote is ready.
- To end wireless mode, press and hold the Wireless Mode Power Button for 3 seconds until Wireless indicator light turns off.
- NOTE: if the DUO Remote is not operated for 2 minutes, it will turn off automatically to conserve battery power.

Re-Pairing DUO Remote

1. Remove Wireless Receiver if connected. If winch is not directly connected to winch, provide power to winch.
2. Turn on DUO Handheld Controller by pressing power button for 3 seconds.
3. Simultaneously press and hold "IN" and "OUT" buttons
4. Green and Red lights will light solidly, flash slowly then flash quickly.
5. When the indicator lights begin to flash slowly, continue holding both buttons down and reinstall Wireless Receiver.
6. Continue holding both buttons down until Indicators lights turn off. Release buttons and the DUO Handheld Controller is now paired.

Pairing New DUO Remote

Your DUO Remote is paired at the factory. To pair a brand-new replacement remote, follow these steps:

1. Remove Wireless Receiver if connected. If winch is not directly connected to winch, provide power to winch.
2. Turn on DUO Handheld Controller by pressing power button for 3 seconds.
3. Simultaneously press and hold "IN" and "OUT" buttons.
4. Green and Red lights will light solidly, then flash slowly. When the lights begin to flash slowly continue holding both buttons down and reinstall Wireless Receiver.
5. Continue holding both buttons down until Indicators lights turn off. Release buttons and the DUO Handheld Controller is now paired.

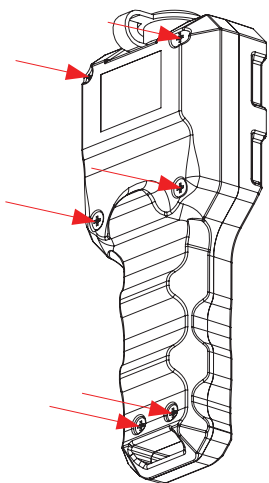

Replace battery

How to replace DUO battery:

1. Remove five (5) screws on back of Handheld remote.
2. Remove back cover to reveal A23 battery.
3. Replace A23 battery with new.
4. Replace rear cover, ensuring rubber seal is aligned and not pinched. This will maintain hand controller waterproof rating.

Troubleshooting	
Symptom	Corrective Action
Winch does not respond to DUO in wired or wireless mode:	Winch is not operational. See winch troubleshooting.
Winch does not respond to Wireless mode but does respond in Wired mode:	<ul style="list-style-type: none"> • Re-Pair DUO Controller • Replace DUO Battery

DANGER

Never touch the rope or hook while they are in tension or under load. Even at rest, the winch may have the rope in tension. Never guide a rope under tension onto the drum with your hands.

- Always winch with at least five (5) wraps of wire rope or eight (8) wraps of synthetic rope around the winch drum. With fewer wraps, the rope could pull loose from the drum under load.

- When pulling a load, place a dampner or blanket, jacket, or floor mat over the rope near the hook end (see illustration). This will slow the snap back of a broken rope and help to prevent serious injury. Raise hood to protect windshield.

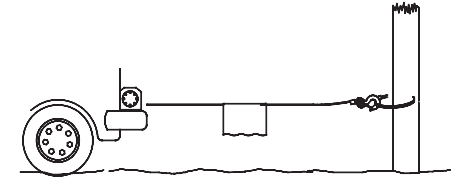

- Double line with a pulley block to reduce the load on the winch, rope and vehicle battery. Double lining will also reduce winch line speed. Be sure all equipment used meets the winch's maximum line pull rating. When double-lining, pulley blocks should be rated to a minimum of two times (2x) the winch's line pull rating.

- If you install a tow hook for double lining, it should be attached to the vehicle frame.

- Equipping the winch with included fairlead will reduce wear on the rope during angle pulls. The rollers reduce rubbing and rope abrasion.

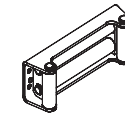

Roller Fairlead



Hawse Fairlead

- Pull as straight as possible to reduce buildup of rope on one end of the drum. It is critical that the winch operator ensures there's not a dangerous buildup of rope on the drum that could impede safe winch operation.

- The vehicle's engine should be running during winching operation. If considerable winching is performed with the engine off, the battery may be too weak to restart the engine.