

Holiday
PRODUCTIONS

THE Arboretum
AT FLAGSTAFF

Welcome to Your Wedding

AT 7,150 FT





THE **A**rboretum
AT FLAGSTAFF



Table of Contents

Reception Tent		6-8
	Tent Pricing	8
Climate Control		9
Tables & Chairs		10-12
Dance Floor		13
Sound Support		14
Lighting Packages		15-21
Arches		22-24
Tent Leg Curtains		25
Yard Games		26
Hand Wash Station		27
Wine Barrel Bars		28
Food & Beverage		29-32
Place Setting Extras		32
Decor & Floral	Birdcages	33
	Lanterns	34
	Wood Elements	35
	Candle Holders	36-39
Floral Accessories	Glass Terrariums	40
	Gold Pedestal Bowls	41
	Goblet Vases	42
	Candlestick Vases	43
	Glass Pillar Vases	44
	Bud Vases	45
	Dark Wood Boxes	46
Faux Succulents, Flowers, Garlands and Trees		47-49
Signage		50-53

Congratulations!

You have chosen to hold your wedding at one of Northern Arizona's most beautiful and intimately enchanting venues! The Arboretum's natural beauty speaks for itself and is a favorite spot for both local couples and destination weddings.



While the rustic charm of the property needs little adornment, there is a good deal of production that needs to take place to make it the perfect space for your world class wedding. In the following pages you will find plenty of information and products that are available for rent to help ensure that you and your guests will have all of the necessary amenities while enjoying the Arboretum's simple elegance.



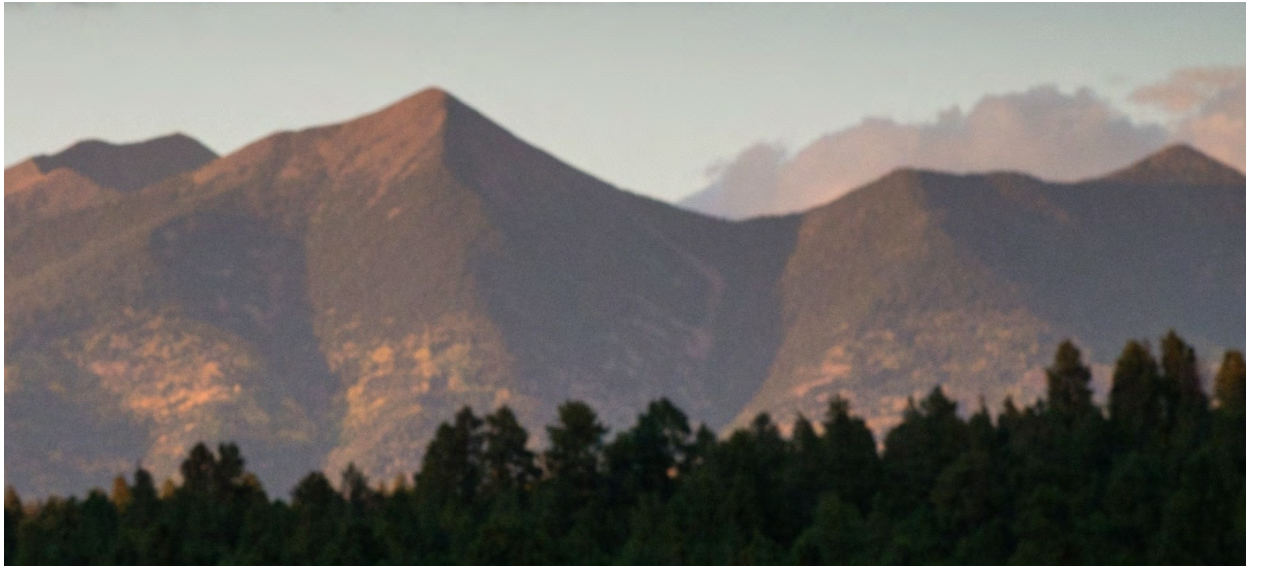

The Reception Tent



Regardless of what time of year your wedding will take place, an event tent is a necessary addition to ensure that all of the priceless details and personal touches you have worked so hard on are protected from the elements. Whether there is a chance of a sudden monsoon storm, or simply the relentless Arizona sunshine, a 40' x 60' canopy, at a minimum, is required for all receptions that are held in the Arboretum's Ponderosa Pavilion.

The good news is that you can rest assured your precious plans and investment will be sheltered. Also, there is no need to seek out a supplier for this massive equipment, because you can source the ideal solution right through your Wedding Coordinator. And unlike other providers, premium clear sidewalls are included in the price that you pay, and will be available at a moment's notice, should weather or temperature necessitate.



Premium clear sidewalls help to keep heat inside the tent, and cold, wind and rain out. If they are not needed, they can be left rolled up and out of sight.



The tent's inner frame provides the perfect support for endless lighting and décor options.

40' x 60' STANDARD FRAME TENT

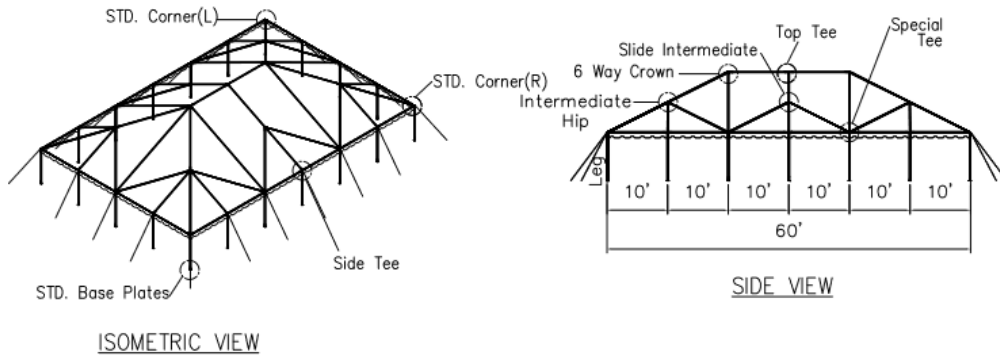
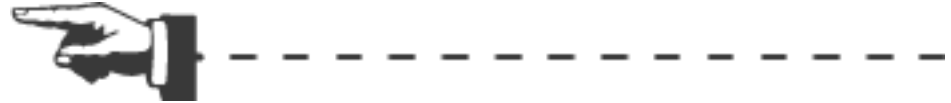

The standard 40 x 60 canopy, that is required at minimum, will comfortably shelter a party of up to 150 guests, Please consult with your wedding coordinator for floor plan advice, especially for larger parties.

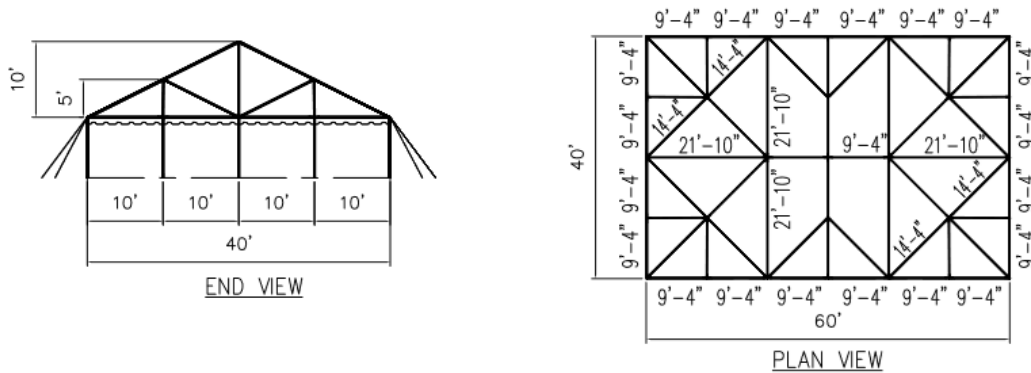

40 x 60 Canopy

\$1750.00

With optional premium clear sidewalls.

INCLUDED

PRICE INCLUDES INSTALLATION.



For parties between 150-200, additional canopies may be needed, and can be sourced from another rental provider. Prices vary, and may be subject to change, but are usually approximately **\$700-\$1000**, in addition to the price of the main 40 x 60 tent.

Diagram to the right illustrates potential placement of additional 20 x 30 canopies.

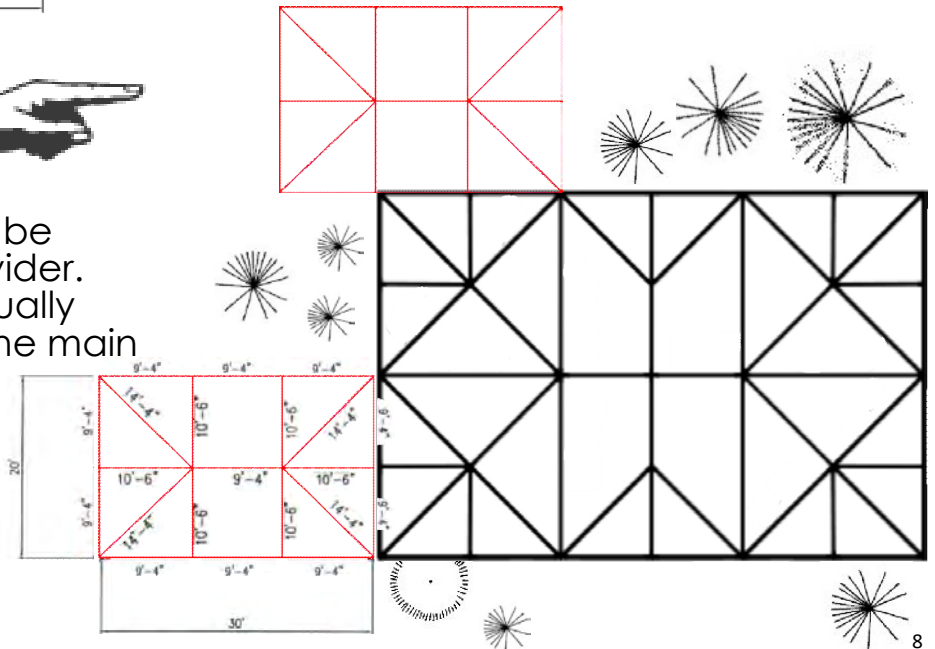



Climate Control

You probably chose Flagstaff for your wedding for many reasons, one of which might be the beautiful weather that is almost certain. While crossing your fingers and hoping for sunshine just might work, having a back up plan is our rule of thumb. Spring and Fall are likely to bring chilly winds or showers, and the summer monsoon rains are a daily possibility between July and September. Even in June, our most predictably glorious weather month, the temperatures might dip below comfort level after dark. Luckily, we have options that can be added nearly at the last minute to ensure that nothing will put a damper on your wedding celebration!

***41,000 BTU Stainless Steel Propane Patio Heater**

\$95.00 each

Propane Included.

**These heaters cannot be used underneath the canopy, to avoid fire hazard. They can be placed just outside the perimeter of the canopy where guests can go to enjoy the warmth they provide. Heats approximately 115 square feet surrounding the heater.*



170,000 BTU Forced Air Propane Heater (not pictured)

\$200.00

Propane Included.

The best heating bang for your buck! This is a forced air unit that sits outside of your sidewalled canopy (sidewalls must be down for this type of heater to do its job). A specially designed vent delivers warm air to the inside, and will easily heat the entire tent, even if additional 20' x 30' tents are added.

Tables & Chairs

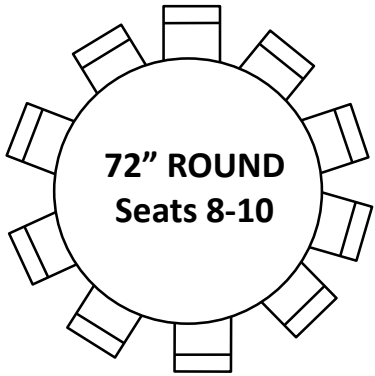

\$12.00 each

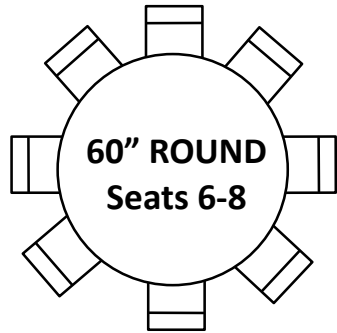

\$10.00 each

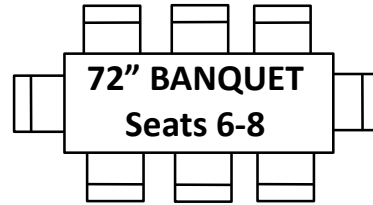

\$10.00 each

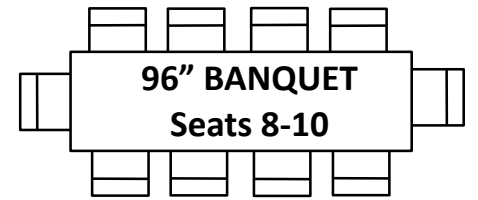

\$12.00 each

Please consult your Wedding Coordinator for advice on what size/shape tables will be best for your party.

30" and 36" ROUND tables

Can be either 30" (standard dining height)
or 42" (cocktail or 'highboy' height)

\$12.00 each



Dark Wood Garden Chairs

With ivory vinyl padded seats

\$2.50 each

*You can use the same chairs for both ceremony and reception.
Our crew will happily transport them over after the ceremony at no additional charge.*





Pedestal Tables \$50.00 each
4 Available



Sweetheart Chairs
\$15.00 each



Turned Leg Wooden Sweetheart Table \$75.00

Hairpin Leg Sweetheart Table \$75.00
Macrame Table Runner \$15.00

Shown with *Cake Veil* \$25.00

Sweetheart Chair Extras

\$50.00 as shown
in addition to sweetheart chair rental

*Lots of options!
Your imagination is the only limit.*





*Please see the
Linen Catalog
for a wide selection of
available table linens*

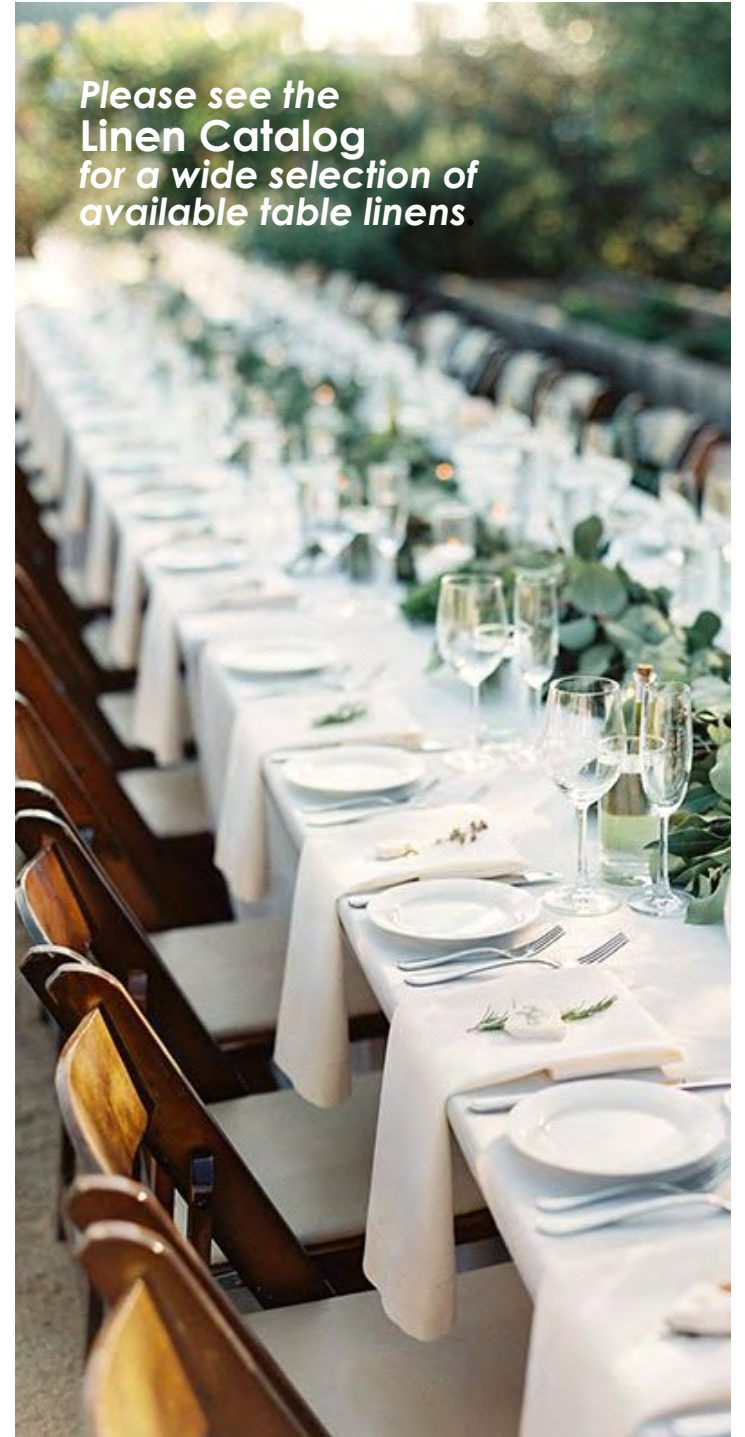



Dance Floor



Like the majority of the grounds at the Arboretum, the Ponderosa Pavilion's natural ground cover is comprised of wood chip mulch and pine needles, which can easily become splinters in the feet of wedding shoe-clad dancers.

An installed dance floor will be a welcome addition if you are planning for dancing to be a major component of your reception's festivities.

What size dance floor will I need?

Up to 100 people	12 x 12	\$300
100 -150 people	16 x 16	\$450
150 - 200 people	20 x 20*	\$625

***Note:** a 20 x 20 dance floor would likely need to be located outside the main tent for a party of 150 or more.

Sound Support

Hiring a professional DJ or musician is a fool proof way to keep the party rocking. However, if you are up for the do-it-yourself challenge, make sure your playlists will have plenty of amplification with our easy to use equipment.

Remember that you will still need to provide all of your own music on compatible devices, as well as a person to man the equipment. This is especially crucial for ceremonies that have multiple elements that require microphones. You may need to add additional sound support services to your Coordination contract to ensure that an experienced person is monitoring the equipment. Please consult with your Coordinator as you are developing your DIY sound plan.

BEST FOR CEREMONIES

Bluetooth and AUX compatible PA system, Single Speaker w/ Stand **\$150.00**

2 Wireless Lapel Microphones with Mixer (for officiant and couple) **\$100.00**

*Up to 2 Additional Wired Mics with Mixer and Stands (for readers, musicians) **\$100.00**

****Will require additional service with your Coordinator.***

BEST FOR RECEPTIONS

Bluetooth and AUX compatible PA system, Two Speakers w/ Stands **\$250.00**

*Wired Microphone w/Stand **\$50.00**

****If you have already rented Wired Mics for your ceremony, no additional rental is needed for Reception.***

Lighting Packages

This is arguably one of the most important elements of the entire wedding. Lighting can make (or break) a party's ambiance, and should be one of the first things in place when designing your wedding's overall décor.

As you've learned, The Arboretum is an extremely sensitive property. Installing the lighting in the appropriate way will take time and expertise. It is required that the Holleday Productions team provide your lighting package. We will gladly do the heavy lifting for you; your lighting wish is our command!

There are limitless ways to make sure your wedding is one that your guests will never forget. The artistry and imagination that goes into unique and elaborate lighting installations is one of the most rewarding and enjoyable parts of the job for us. This is where the magic really happens! The following pages contain just a few fun examples.



Above is the trail to the restroom building magically lit with Warm White LED Twinkle Lights.

This is a mandatory element of your lighting package, to ensure convenience and safety for your guests as they navigate to the restrooms after dark.

Restroom Path Lighting

\$300.00



Basic Bistro Package

Bistro Strands at Perimeter of 40' x 60' Tent

\$225.00

Bistro Strands Crossing 40' Width of Tent (two additional strands across center of tent)

\$200.00

The Basic Bistro Package provides ample lighting for your reception tent, and is our best selling lighting package.





Bistro Greenery Upgrade

Faux Greenery to adorn the Bistro Strands
Crossing 40' Width of Tent

\$200.00 (in addition to Bistro Strands)

Both installs shown with Garden Chandelier
(detail below)

Garden Chandelier additional **\$150**

Draping Garlands

Warm White Twinkle lights and
faux garlands dramatically
drape from center peak of tent.



Draping Garlands
\$800.00



Twinkle Lights Fantastic

Warm White Twinkle lights cross 60' width of tent to create a sparkling ceiling of twinkling lights.

7 strands

\$1000.00

15 Strands
(as shown Left)

\$1500.00

Grapevine Globe Chandeliers



NOTE: This installation was not at the Arboretum, but a similar effect could be achieved.



Whimsical spheres of tangled grapevines with warm white twinkle lights.

Includes one 18" & four 12" globes **\$350.00**

*Shown at left with the addition of **Organza Drapery**, next page.*

Organza Drapery

Twenty-eight panels of shimmering ivory organza line the entire tent canopy for a luxurious and elegant effect.



Organza Drapery
\$1500.00

Shown with...

Warm White Twinkle Canopy
\$800.00

...and...

*Garland Ring
Chandeliers*
Two 18" & One 36"

\$350.00



Paper Lanterns

So fun and festive! Pricing varies; lantern packages start at **\$800.00**, and can go up to **\$2000.00** or more.



Disco Ball

16", with two spotlights

\$150.00



Arches

While the stunning backdrop of the San Francisco Peaks really needs no embellishment, a ceremony arch is a simple way to frame the scene for the perfect photo.



Garden Arbor Arch **\$200.00**

FLORAL ADDITIONAL



Burlap
Aisle Runner
\$75.00



A-Frame Arch **\$150.00**

FLORAL ADDITIONAL



Aspen Branch Arch **\$150.00**

FLORAL ADDITIONAL



Majestic Beam Arch **\$250.00**

FLORAL ADDITIONAL

Vintage Door Arch

\$250.00

This arch needs to be staked to the ground, and cannot be used on the Garden Stage. However, a set of vintage doors makes for the perfect transition to your ceremony or reception tent. What an elegant way to make an entrance!



FLORAL ADDITIONAL

Shown with *Rustic Wine Barrels* **\$50.00** each

Tent Leg Curtains



A simple way to add instant elegance to your reception tent.

For all 20 tent legs. Includes Faux Greenery ties.

\$300.00



*Sheer Curtain
Backdrop with
Twinkle Lights*

Great for Sweetheart
Table or Photo Booth

\$150.00





Yard Games



Giant Jenga

Includes Small Table
for Set-Up

\$50.00



*Personalized
Corn Hole*

Includes Custom Chalk Lettering

\$100.00



Giant Connect Four

\$50.00

The Addition of Yard Games to your reception will likely necessitate the Addition of extra Light Strands to Light that Area, usually around \$100.00.

Hand Wash Station

\$50.00



Developed as a necessary precaution during 2020, the Hand Wash Station has become a welcome addition to receptions, as the nearest sinks are several hundred yards away.

Wine Barrel Bars

Perfect as a bar, dessert table, even a gift table!
We have two available, so you don't have to choose.



Wine Barrel Bars

\$150.00 each

Single Rustic Wine Barrels

\$50.00 each



Food and Beverage.



Three Tier Small **\$25.00**



Rustic Wood Food Stands
Lots of sizes and styles.



Three Tier Large **\$25.00**



Single Tier **\$15.00** each



Cake Stumps **\$15.00** each

Cake Stands



Vintage Cake Stand

Above, 16" Diameter **\$25.00**

Ceramic Cake Stands

Below L, 14" Square **\$15.00**

Below R, 10" Round **\$15.00**



Glass Candy Jars

Left **\$5.00** each



Glass Cake Stands

Above **\$10.00** each

3 Tier Metal & China Stand

Below **\$25.00**



Antique Turned Wood Cake Stand

Above, 18" Diameter

\$25.00

Pink Ceramic Cake Stand

Right,

7" Diameter

\$10.00



Silver Pedestal Cake Stand

Above, 15" Diameter

\$25.00

Beverage Dispensers

All Dispensers
\$20.00 each



Pebble Glass Dispenser



Glass Lid Dispenser



Mason Jar Dispenser

Mason Jar Mugs & Bar Glasses
(also great as Flower Vases)

\$1.50 each

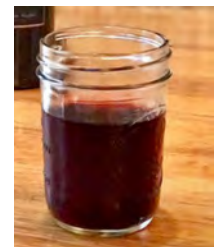

Place Setting Extras

Gold Beaded Chargers **\$1.00** each
(also available in Silver)

Flower Napkin Rings **\$2.00** each
(also available in other styles/colors)

Gold Jewel Napkin Rings or
Grapevine Napkin Rings **\$1.00** each

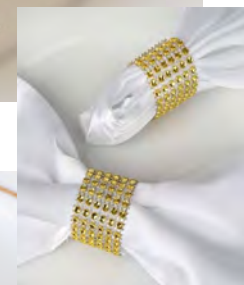

Décor & Floral

Just like lighting, the decor and floral elements that you choose for your wedding are a huge part of setting your event apart from all the others. Here is where you can get highly personal and customized to make sure that the items you use reflect your style and personality as a couple.

You may have your heart set on sourcing and shopping for these elements yourself, or even crafting the perfect DIY centerpieces. If so, we heartily support you, and will still happily set everything up for you on the big day!

However, if the idea of renting those items appeals to you, please browse the final pages of this catalog to see all of the ways that we can help decorate every facet of your perfect day.

NOTE: In general, all floral elements and candles will be an additional rental fee.

Birdcages

\$5.00 each

...perfect with...

Lovebird
Salt & Pepper
Shakers

\$3.00 /set
includes S&P



Lanterns



Clockwise from Below Left:

Assorted Vintage White, Assorted Vintage Metal, Black Metal, Gold Metal, Dark Wood

ALL \$10.00 Each

Below: Mini Assort. Metal (includes LED tealight)

\$10.00 per 10



Wood Elements



BELOW:
Twig Card
Basket
\$10.00



RIGHT:
Twig Vases
\$3.00 each



Clockwise from Above:

- Ceremony Aisle Pine Stumps **\$15.00** each
- Small Pine Stumps **\$40.00** for 40
- Small Aspen Stumps **\$35.00** for 35
- Wood Slice Centerpiece Bases **\$ 5.00** each





Candle Holders



Clockwise from Left:

Glass Cylinder Candle Holder Vases in Assorted Sizes (2 pics) **\$70.00** for 70

Assorted Wood Candlesticks **\$75.00** for 15

Last Photo Shows Combination of Both.

*LED Candles **\$1.00** each

**** Required at Arboretum for Fire Safety.***

Candle Holders ...continued...



Above and Below:

Gold Filigree Candle Holders
in Assorted Sizes & Patterns

\$105.00
for 35



Right:

Gold Wire Polygon
Candle Holders

*Also great for Flowers
and Succulents!*

\$44.00 for 22*



Right:

Gold Mercury Glass
Candle Holders

\$24.00 per 24*



Right:

Gold Glass Mosaic
Candle Holders

\$27.00 for 9*



***Includes LED Tealights.**

Candle Holders

... continued ...



12 Arm Candelabra **\$20.00**
*LED Tapers **\$1.00** each
**Required at Arboretum for Fire Safety.*



Above & Top Right:
5 Arm Candelabras
\$15.00 each

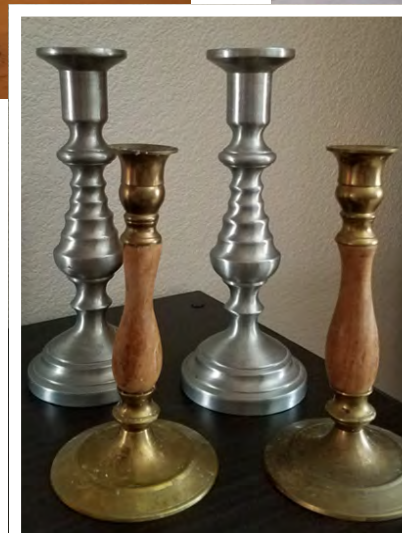

Right & Far Right:
Single Candlesticks
\$5.00 each



Candle Holders ...continued.



Glass Terrariums

RIGHT:
Glass Terrarium
Card Box
\$10.00



Large **\$10.00** each

Small **\$ 5.00** each

*LED Candles **\$1.00** each

****Required at Arboretum for Fire Safety.***

***See Following Pages for Fabulous
Glass Terrarium ideas with Succulents and Flowers!***

Floral Accessories

If you are planning to utilize Holleday Productions for your Floral Package, then any of these accessories are probably already worked into your Floral Package pricing (or can be).

If you are creating your own flowers, or working with another florist, then you can still plan to rent any of these items for you or them to use!



Glass Terrariums

Large

\$10.00 each

Small

\$ 5.00 each



Gold
Pedestal
Bowls

\$12.00
each





Above:

*Bejeweled
Goblet Vase*

ALL THIS PAGE:

\$12.00 each



Above:

**Gold Goblet Vase*

**Also available as Champagne Flute style*

Below:

*Hurricane
Goblet Vase*



Candlestick Vases

Below:
Clear Glass Pedestal Vases
\$5.00 each



Below:
Black Lacquer Candlestick Vases **\$10.00** each



NOTE: All floral this page is faux, and available for additional rental fee. Please inquire for pricing.

Below:
Vintage Country
Candlestick Vases
\$10.00 each



Glass Pillar Vases

Impressively large! **6" x 20"**
And versatile!



Glass Pillar Vases
\$20.00 each

LED Floating Candles
\$2.00 each

Battery Powered
Fairy Lights
\$2.00 per strand

Bud Vases



\$1.50
each

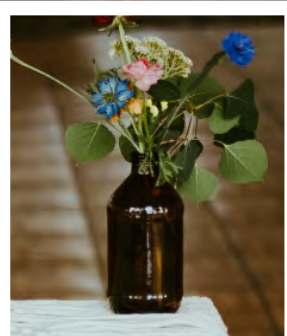

So. Many. Styles. Sizes. Colors.



Dark Wood Boxes

Square and Rectangle

\$10.00 each



Fabulous Faux

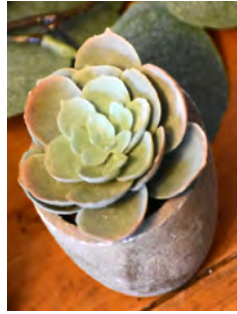

This Panel: Black Ceramic Eucalyptus or Lavender Planters

Top Right: Clay Planter **ALL \$5.00** each

Bottom Right: Ceramic Prism Planter

Above Left (2),
Right and Below:
Assorted Mini
Succulents
\$2.00 each

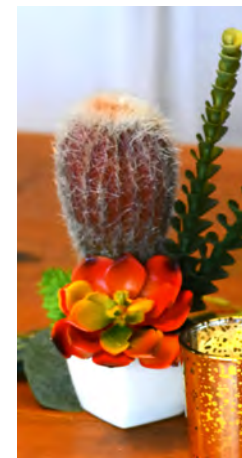

We all love real flowers and plants, but sometimes faux is best! We have learned the hard way that living plants, like succulents, don't always survive the excitement of a wedding.

The faux options are so realistic, not even we can tell them apart!

Faux Garland

Sometimes faux is the way to go! Especially when mixed and matched with real flowers and greenery, supplementing with a bit of faux garland can go a long way to stretch your floral budget.

**\$5.00-
\$10.00**
each

Spring Flower



Pink Flower



Eucalyptus



Aspen



Lamb's Ear



Red Rose



Fall Leaves



White Calla Lily





Faux Trees

Just in case we need a little more green.
And twinkle lights.

\$25.00 each



Signage



Chalkboard Arrows
and Vintage Trays

\$10.00
each

Marquee Signs:

BAR

\$15.00

Ampersand and Arrows

\$5.00 each



Includes Custom Chalk Lettering.

Signage

... continued ...



Hand Lettered Dark Wood Table #'s one - eight **\$20.00**
 nine - sixteen **\$20.00**



Gold Border Table #'s 1-12 **\$20.00**
Includes printed cards.



Black Wood Block Table #'s 1-13 **\$20.00**
Includes printed cards.



Chalkboard Easel Table #'s 1-12 **\$20.00**
Includes custom lettering.

Signage

... continued ...



Tall Gold Wire Heart
Sign Holder



Short Silver
Sign Holder

ALL
\$2.00
each

Includes printed cards.

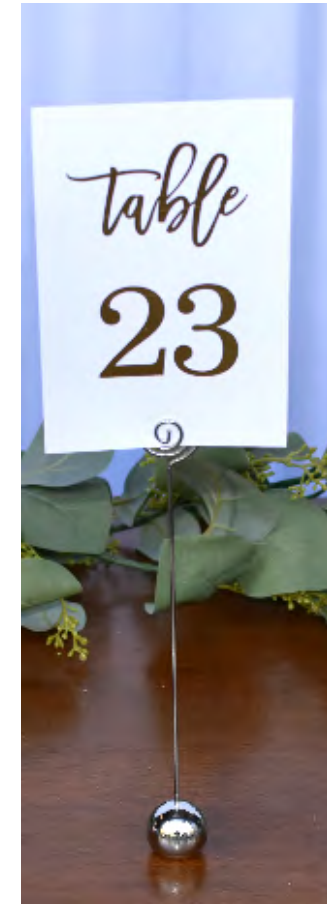

Tall Silver
Sign Holder

Signage ... continued.



Ornate Frame Table #'s 1-21 **\$3.00** each

*Includes printed cards.
Can also be used at buffets, favor tables, etc.*



Beaded Gold Frames **\$2.00** each



Carved Gold Frames
*Perfect Escort or Name Card Holders.
Includes printed cards.*



Large Ornate Chalkboard Frame **\$12.00** each

Small Metal Easels **\$2.00** each

Large Metal Easels \$10.00 each
(not pictured)

best
day
ever

The Beginning.