

DELWP STANDARDS FOR BATHING BOX AND BOATSHED

CONSTRUCTION GUIDELINES 2015

Consultants:

ALLEN KONG ARCHITECT

1st floor 464 Victoria Street, North Melbourne VIC 3051
PH (03) 9328 2320 FX (03) 9328 3401

Project Architects: Pene Rice and Paul Haar

P.J. YTTTRUP & Associates Pty. Ltd. Consulting Engineers
33 Roberts Road, Belmont, Geelong VIC 3216
PH (03) 5243 3388 FX (03) 5244 3023

Project Engineer: Peter Yttrup

JILL ORR-YOUNG LANDSCAPE ARCHITECTS

63 Sandringham Road, Sandringham VIC 3191
PH (03) 9521 9929

Project Architect: Jill Orr-Young

AINLEY PROJECTS

12/109 Tulip Street, Cheltenham VIC 3192
PH (03) 9584 8178

Project Manager: Belinda Ainley

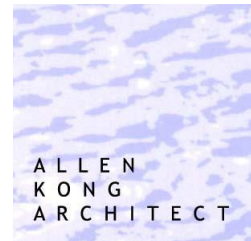

CONTENTS		Page
1.	Introduction	4
2.	Scale & Proportion	5
2.1	Bathing Box	6
2.1.1	Building Envelope	6
2.1.2	Openings	7
2.2	Boatshed	8
2.2.1	Building Envelope	8
2.2.2	Openings	9
3.	Construction Principles	10
3.1	General	10
3.2	Appropriate Materials	10
3.3	Structural Integrity	10
3.4	Loading Conditions	11
4.	Construction Practice	12
4.1	Structural Framing	12
4.2	Framing Members	13
4.2.1	Framing Sizes	13
4.3	Wall Frames	13
4.3.1	Construction Details	14
4.4	Floor	15
4.4.1	Floor Framing	15
4.4.2	Stumps	16
4.4.3	Trimmer Beam	16
4.4.4	Bearers	16
4.4.5	Joists	16
4.4.6	Construction Details	17
4.5	Roof	18
4.5.1	Rafters	18
4.5.2	Ridge	18
4.5.3	Roof Battens	19
4.5.4	Construction Details	19
4.6	Claddings	20
4.6.1	Floor Cladding	20
4.6.2	Wall Cladding	21
4.6.3	Plinth Board & Plinth Battens	23

		Page
4.7	Openings	24
4.7.1	Frames	24
4.7.2	Shutters & Panels	24
4.7.3	Vents	24
4.8	Threshold – Porch, Ramp & Decks	25
4.8.1	Framing	25
4.8.2	Decking	25
4.8.3	Treads & Stringers	25
4.9	Roof Sheeting & Decoration	26
4.9.1	Roof Sheeting	26
4.9.2	Capping	26
4.9.3	Fixing	27
5.	Decoration	28
6.	Fasteners	29
6.1	Nails	29
6.2	Screws	29
6.3	Straps	29
6.4	Bolts	29
7.	Hardware Systems	30
7.1	Hinges	30
7.2	Catches & Locks	31
7.3	Handles	32
8.	Finishing	32
8.1	Extent of Paintwork	32
8.2	Paint Selection	33
8.3	Maintenance	34
9.	Appendix A Bathing Boxes Mount Martha North	35
10.	Appendix B Timber	36
11.	Appendix C Metal	38
12.	References	39

1. Introduction

These Standards have been prepared for the Department of Environment and Primary Industries, as part of the department's review of the Bathing Box and Boatshed Policy Guidelines. It encompasses the structures known as Bathing Boxes and Boatsheds, located on Victorian coastal Crown land. Specific construction standards apply to Mount Martha North Beach bathing boxes numbers 92 to 151 (Appendix A - Bathing Boxes – Mount Martha North). This document is to be read in conjunction with the Bathing Box and Boatshed Policy and Management Guideline produced by the Department of Environment and Primary Industries.

These Standards provide a prescriptive code for the selection of appropriate materials and approved construction techniques. However, a range of details have been included in the interests of inspiring diversity among the Bathing Boxes and Boatsheds. The actual style adopted is left up to the discretion of the licensee and individual expression is encouraged. In addition, the Standards provide useful reference material to aid informed decision making.

Appropriate materials have been selected based on their aesthetic and historical values, as well as technical performance with regard to durability, strength, economic and environmental cost and availability.

Parameters for construction were derived by integrating conventions in small timber construction with specific engineering advice to ensure structural stability on open coastal terrain. This ensures any new structures will be better equipped to endure the rigours of the harsh coastal environment and abide to current day safety standards.

Whilst the Standards specifically address reconstruction of Bathing Boxes and Boatsheds, they may also offer advice for the maintenance of existing structures.

The Standards will be governed by local Foreshore Managers who will have final determination of appropriate use of materials and construction techniques. Adherence to this code will ensure that reconstructed Bathing Boxes and Boatsheds are of the best quality.

2. Scale & Proportion

Scale is the linear measurement of the building (in metres (m), millimetres (mm), etc) and proportion is the geometric configuration (i.e. the shape). Scale and proportion will be used to discuss the building envelope, which is the space occupied by the structure. Openings in the building envelope are the windows, shutters, doors and vents.

The parameters for scale and proportion have been established from a study of existing structures. The department advised of its preferred style for Bathing Boxes and Boatsheds. Samples of these styles of structures were measured and documented to determine the parameters for scale and proportion.

There are two building types recognised – the Bathing Box and the Boatshed. Primarily, the difference between the two is based on scale, but there are differences in proportion also.

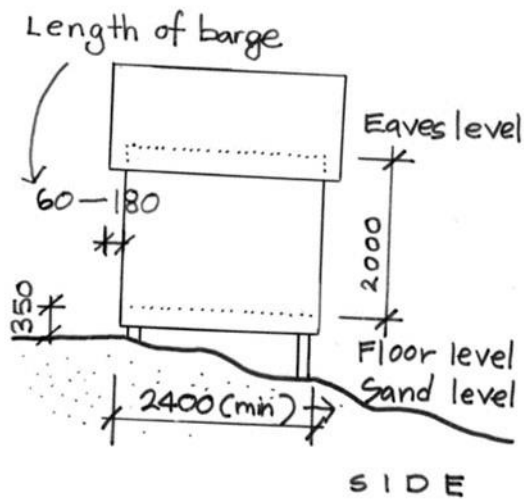

2.1 Bathing Box

2.1.1 Building Envelope

The building envelope is the space occupied by the structure. The following parameters will govern the construction of Bathing Boxes.

The length and width (mm) drawn represent the recommended size for construction according to these standards. Sizes were determined by studying existing examples and following engineering advice. From the minimum size drawn, sizes increase up to a point where it will be deemed to be a Boatshed.

Proportions for Bathing Boxes have been developed using a 'square' facade (front elevation) and thus when the width increases so too should the height, in order to retain the proportion.

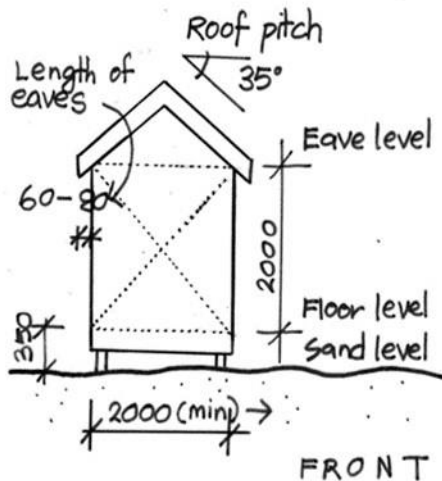

A variety in eave length around the coasts enhances diversity between boxes and bears no apparent relationship to the rest of the box's proportions. However, parameters for the maximum and minimum eave length have been established.

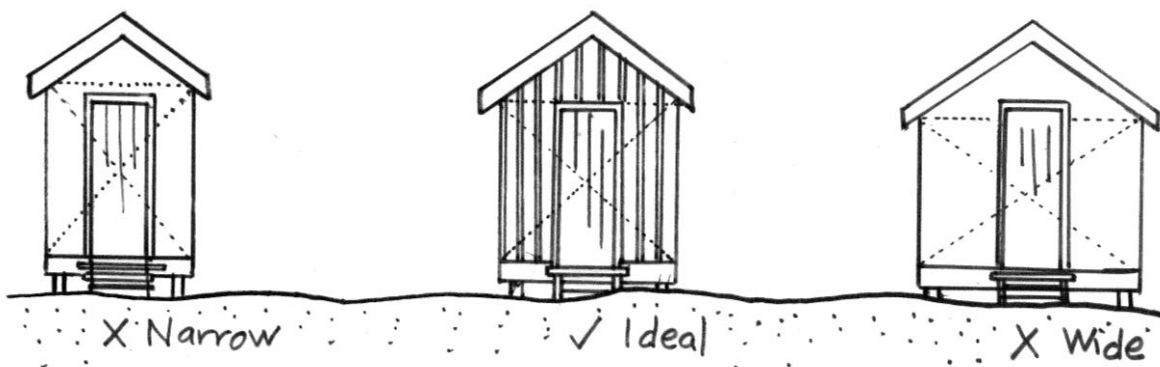

2.1.2 Openings

Openings of Bathing Boxes comprise of shutters, doors and vents.

Positioning of the openings are open to personal choice and a range of possible opening positions have been indicated below.

Doors on existing Bathing Boxes are all roughly the same dimension. Shutter sizes shown here are also based on existing examples.

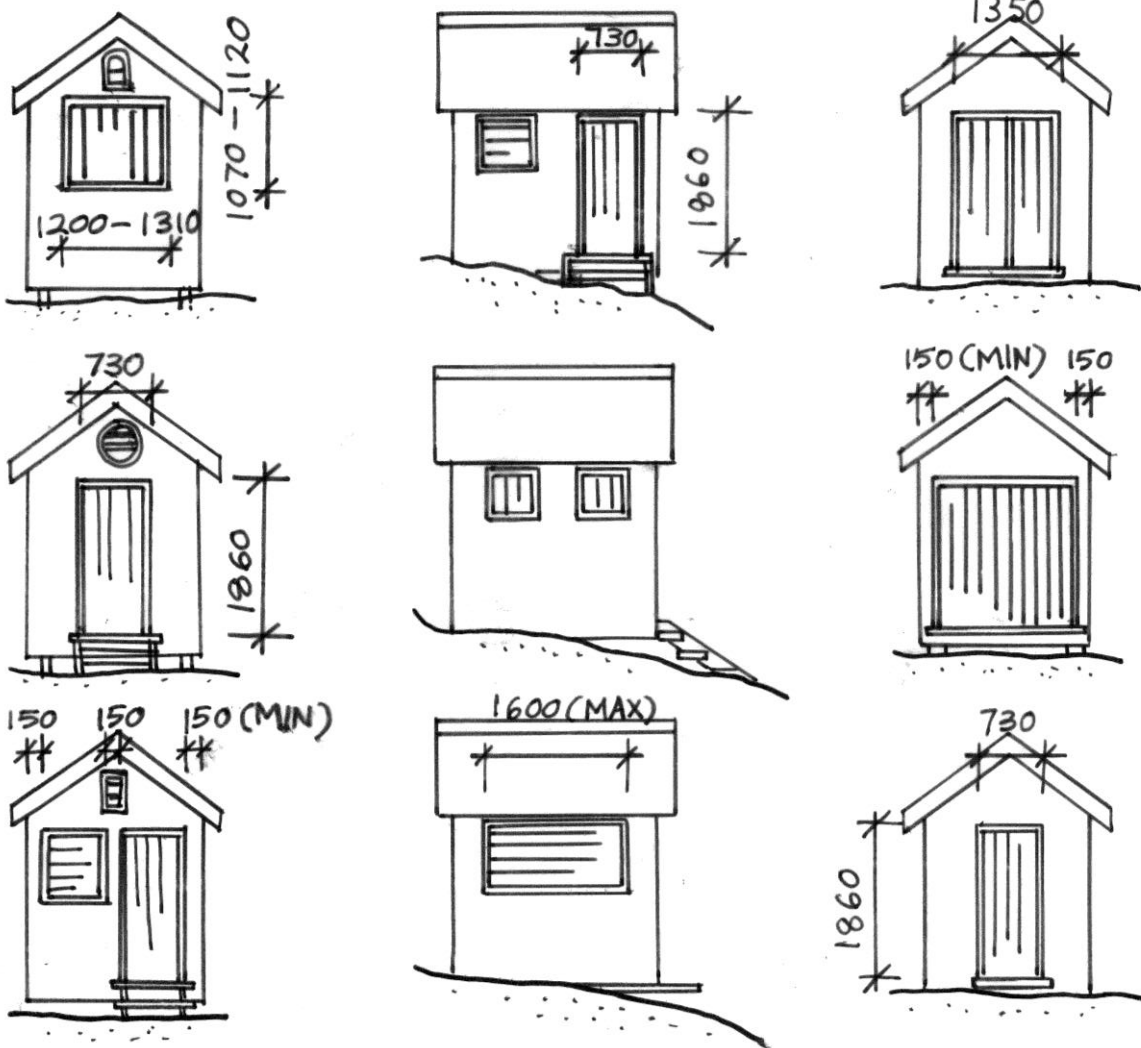

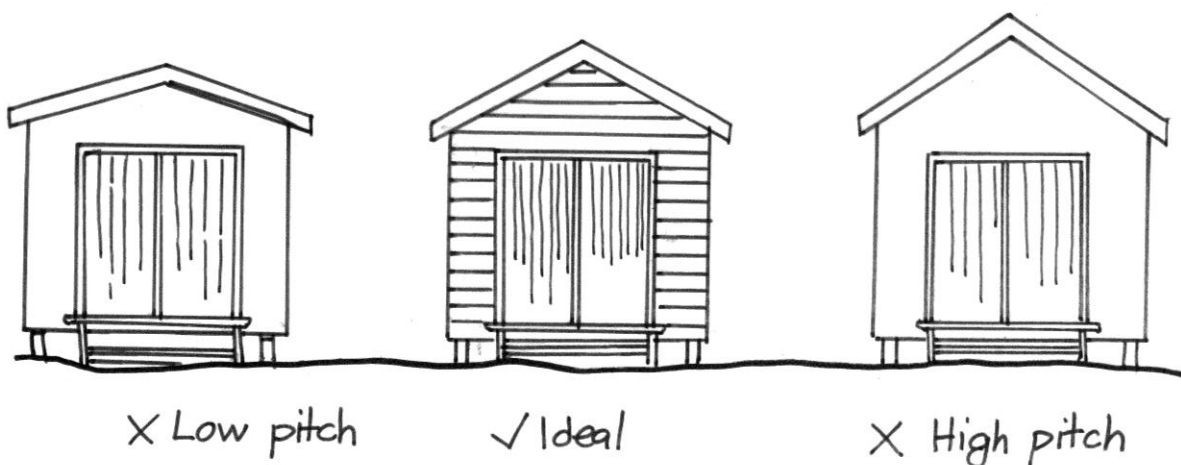
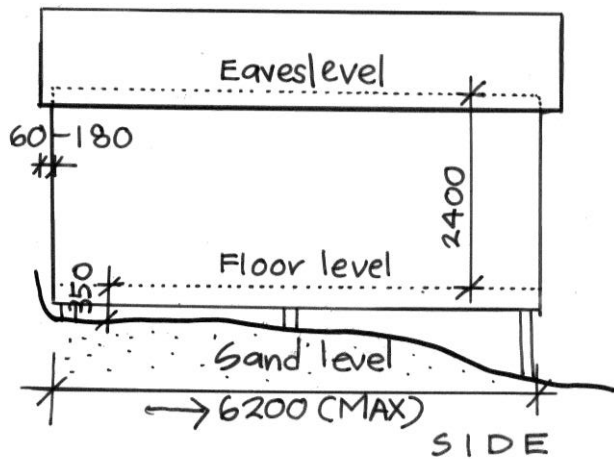
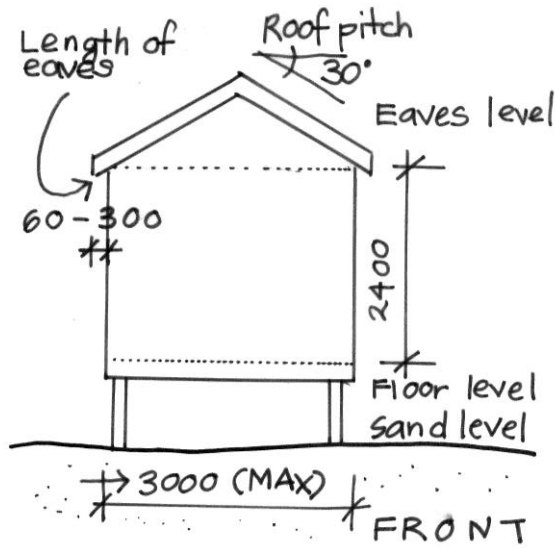

2.2 Boatshed

2.2.1 Building Envelope

The building envelope is defined as the space occupied by the structure.

Boatsheds, being used to store boats have different proportions to Bathing Boxes. With the increased width required, the shed would be too tall if the proportions for the Bathing Boxes were to be used. The building envelope is proportionally more squat with a corresponding lower roof pitch.

The height of the building envelope is fixed while length and width can vary independently based on individual need. The final proportions adopted are to be guided by Foreshore Managers.

The maximum length x width relationship represents the largest Boatshed recommended. As with Bathing Boxes, the length of the eaves is unrelated to the other building proportions.

2.2.2 Openings

Openings for Boatsheds include shutters, doors and vents.

As for Bathing Boxes, the positioning of openings is free to personal choice provided due consideration is given to structural stability.

Positions and sizes shown drawn are recommendations only based on examples along the Foreshore.

(See also Section 4. Construction Practice)

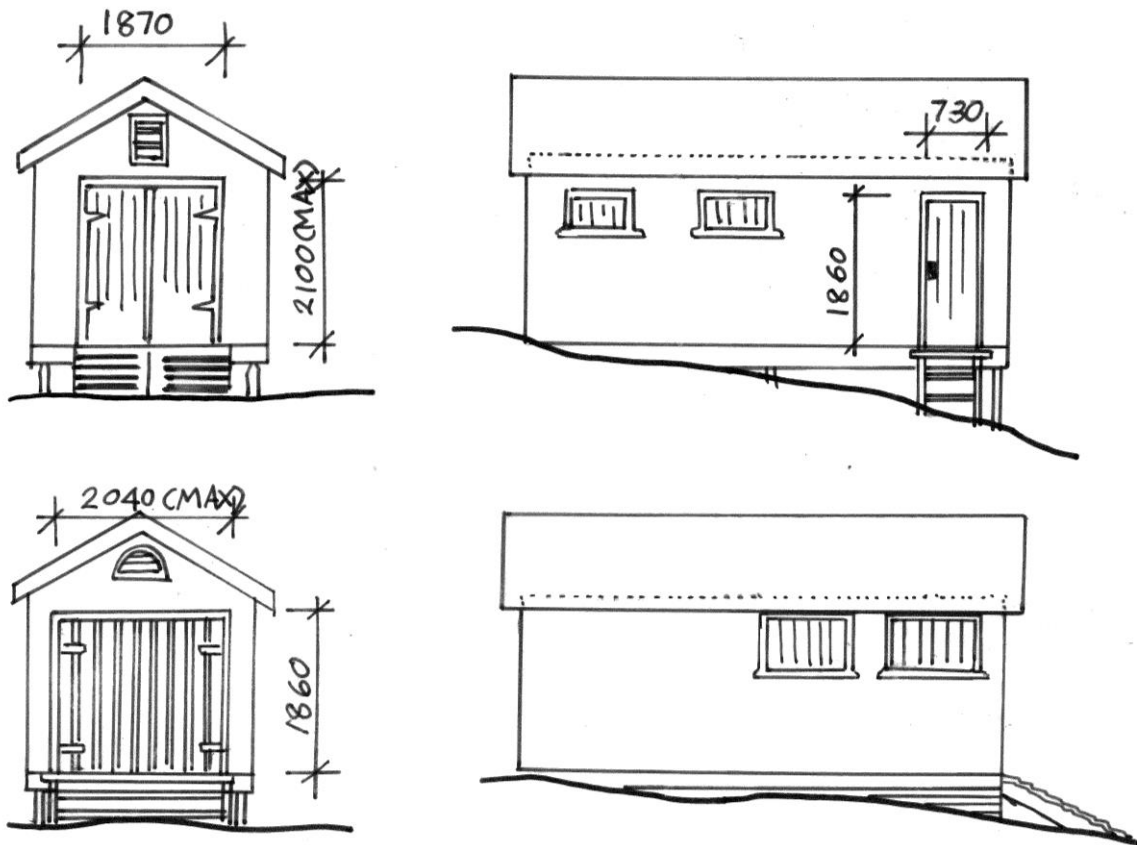

3. Construction - Principles

3.1 General

Bathing boxes and boatsheds are constructed in locations that are subjected to extreme exposure by:

- sun
- high winds
- salt water spray and splash

3.2 Appropriate Materials

Materials need to be selected so as to be suitable for use in these situations.

- Timber (class 1 or class 2 durability, class 3 if internal and coated with preservative)
- Steel (stainless steel or galvanized steel and over painted as a minimum)
- Fixings (stainless steel, zinc coated, bitumen coated)

3.3 Structural Integrity

Construction principles for these structures are common with typical domestic framing construction and should follow the Australian Standards **AS 1684 – Residential timber-framed construction** and **AS 1720.1-1997 – Timber Structures – Design methods**.

Wind loads should be assessed in accordance with Australian Standard **AS 1170.2-2002 Structural design actions – Wind actions**

Critical actions to cater for the exposure conditions need to specifically address:

1. Uplift and overturning of the total unit.
 - Footing size and resistance to uplift/overturning
 - Anchorage of superstructure to footing system
2. Tie down of roof structure to wall system, and wall system to floor system, and floor system to sub floor/stump system.
 - Strap and prefabricated metal bracket systems for all connections
3. Bracing systems.
 - Systems need to be rigid and interlocking and active in two directions and need to be checked into wall framing.
 - Timber (50x25) trenched into wall frame studs and carried over and under top and bottom plates minimum 2 fixings per stud and 4 fixings to top and bottom plates.

- Galvanised steel angle (25x25) notched into wall frame structures and fixed into top and bottom plates. Minimum 2 fixings to studs and 4 fixings to top and bottom plate.
- Sheet bracing – waterproof ply fixed to frame of wall stud and connected onto top and bottom plate. Ply to be glued and screw fixed at 150cc

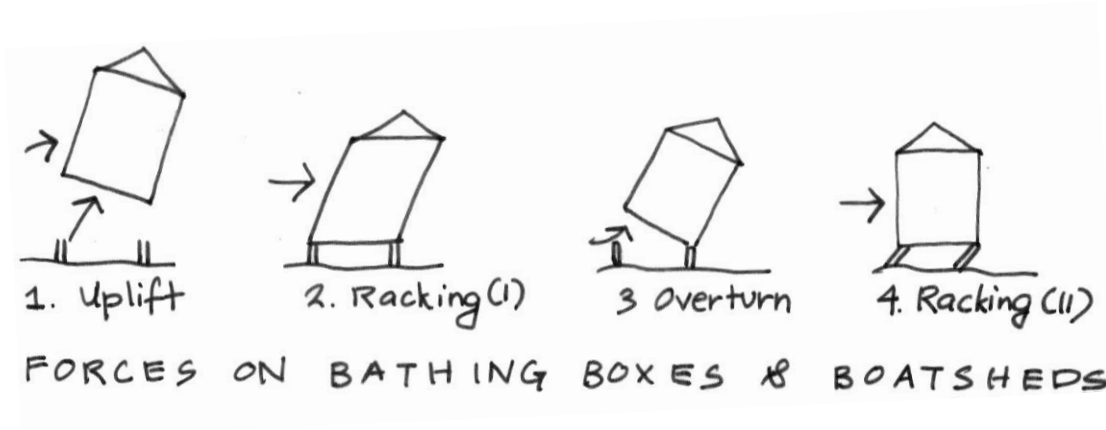

3.4 Loading Conditions

In accordance with Australian Standard AS 1170.2-2002 Structural design actions – Wind actions

- Bathing Boxes – Domestic live load 1.5 kPa
- Boatshed – Domestic live load 3 kPa

4. Construction Practice

4.1 Structural Framing

Timber species have been selected for their availability, durability and price. Termite protection has not been addressed as there has been no evidence of problems for existing Bathing Boxes and Boatsheds, but please check with your local council. Some of the selected timber species are listed in preservative treated form.

A more comprehensive analysis of timber species and preservative treatments is presented in 'Appendix B - Timber.'

Timber is the most suitable commonly available material

- Durable hardwoods (classes 1 or 2)
- Australian Cypress

Structural framing includes:

- Floor framing
- Wall framing
- Roof framing

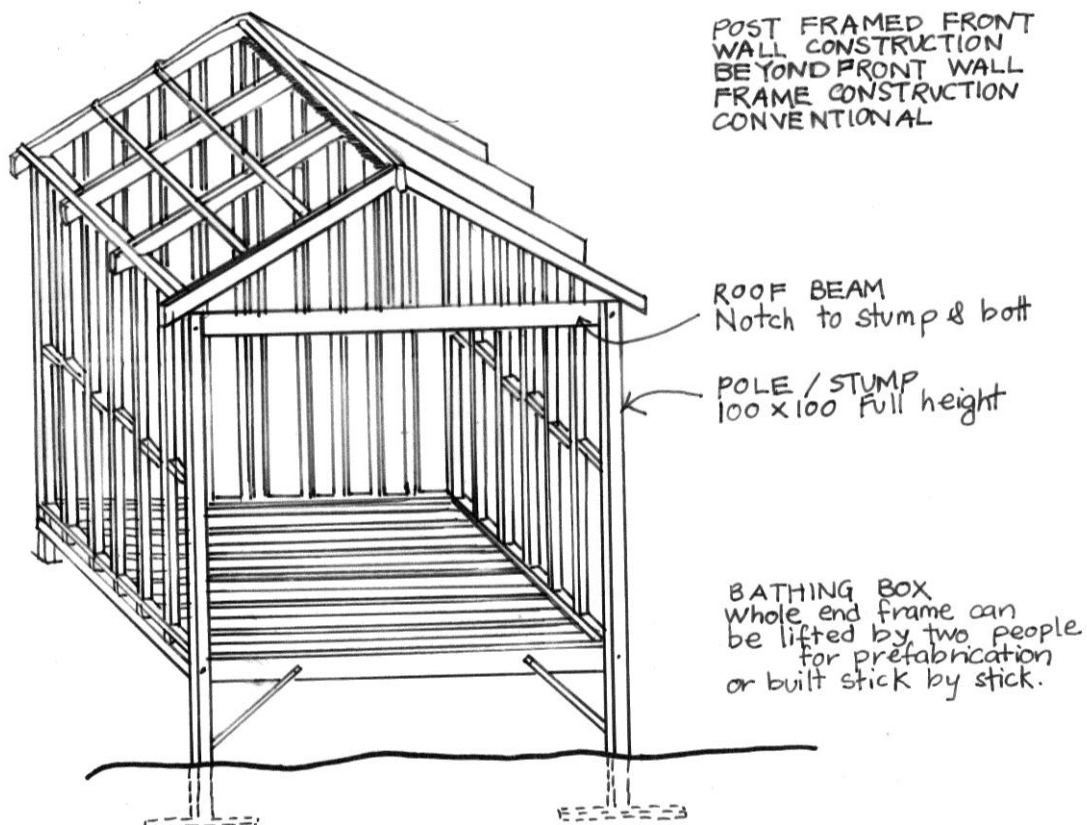

4.2 Framing Members

- Roof battens
- Rafters/Purlins
- Roof beams (ridge)
- Wall frames, top plates, studs, riggings, bottom plates
- Floor systems, joists, bearers
- Sub floor and footing, stumps, sole plate, pad, footing (precast or cast in-situ)
- Trimmers to openings

4.2.1 Framing Sizes

- Bathing boxes 2000 wide x 2400 long
- Boatshed 3000 wide x 6000 long

4.3 Wall Frames

- 2400 high all walls
- 3000 high ridge

- Top plate 90 x 45 HW F8
- Bottom plate 90 x 45 HW F8

- Studs corner and opening 90 x 45 HW F8
- Studs corner 90 x 35 HW F8 @ 450 cc

- Noggings 90 x 35 HW F8 @ 1200 spacing

- Braces – each wall panel 45 degrees approximately rigid member notched into stud or water proof sheet ply 1200 wide panel

Materials

Components of the wall frame include:

- Top Plate (connecting wall frame to rafters)
- Bottom plate (connecting wall frame to joists)
- Studs (assembling as the main structural component for attaching cladding)
- Noggings (restarting the slender studs from buckling under load)

Clad externally, the wall frame is well protected from weather damage and so the timber used here needs to be particularly durable.

- F8OBHW Messmate (*Eucalyptus obliqua*) 90x45
- F5 untreated Seasoned Radiate Pine (*Pinus radiata*) 90x45

4.3.1 Construction Details

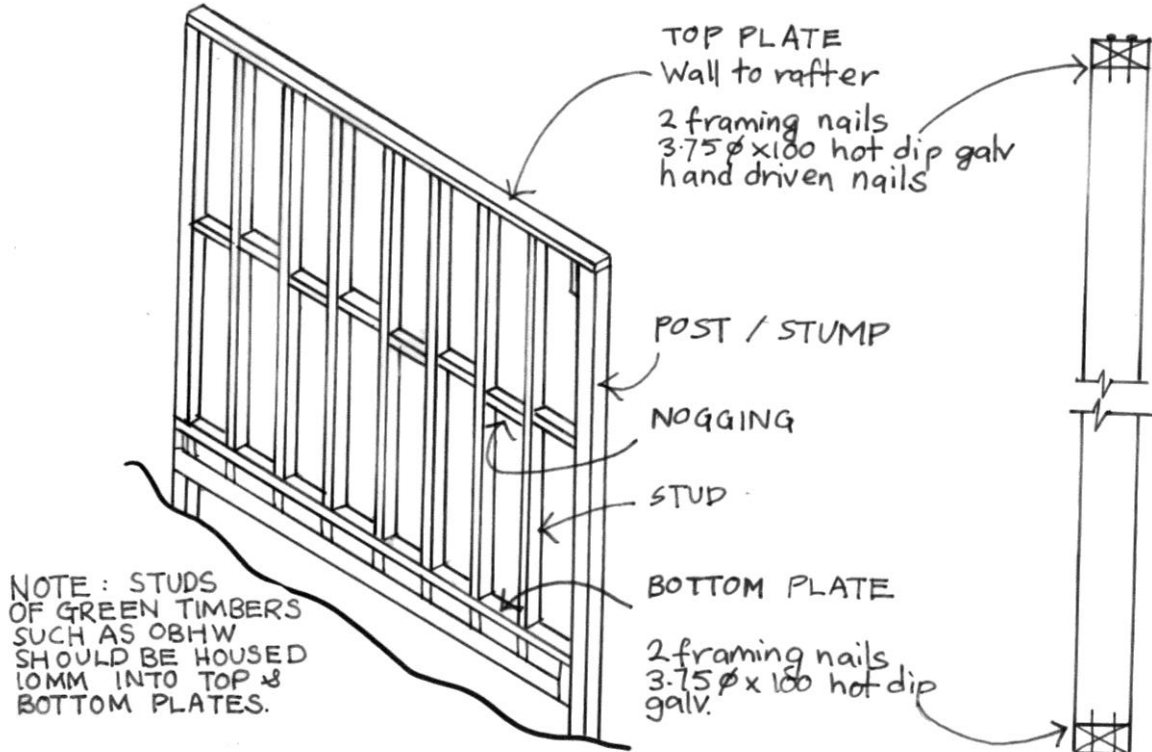

4.4 Floor

Flooring	19mm tongue and groove hardwood 19mm waterproof plywood
Joists	1000 span 90 x 38 HW F8 @ 450cc 1500 span 90 x 45 HW F8 min @ 450cc 2000 span 120 x 45 HW F8 min @ 450cc 3000 span 145 x 45 HW F8 min @ 450cc
Bearers	2 continuous spans 1200 maximum
Bathing Box	100 x 75 F8 HW maximum spacing 1800 125 x 75 F8 HW maximum spacing 2400
Boatshed	100 x 75 F8 HW maximum spacing 1500 150 x 75 F8 HW maximum spacing 2400
Stump	100 x 100 R.C

1 central 10 diameter reinforcing bar galvanized extended from above ground stump and threaded to bolt over bearer.

OR

125 x 125 HW with stainless steel strap plates to comply over bearer.
Stump diagonally braced to floor in 2 directions if over 600 above ground.

Pad Footing 400 x 400 x 300 deep concrete pad 400 below.

In-situ poured pad cast in stump with 10 diameter x 300 long galvanized steel cross bar.

Precast pad provide 150h x 100w, with 10mm thick galvanized mild steel 'U' schedule bolted to pad and to stump with 2 M12 galvanised bolts to pad and to stump.

4.4.1 Floor Framing

Materials

Floor framing consists of:

- Stumps (to back wall) posts (to front wall), providing the crucial link between the building and the ground.
- Trimmer beam (rigid beam tying two front posts together).
- Corbel block (supporting the bearer and trimmer beam)
- Bearer (supporting the joists)
- Joists (main structural component for the floor lining).

4.4.2 Stumps

Stumps are in direct ground contact and therefore require very durable timbers. Suitable material available which are similarly priced:

- White Cypress Pine (*Callitris glauca*) 100 x 100mm

4.4.3 Trimmer Beam

The edge beam is not in direct ground contact nor directly exposed to the weather.

- F8 OBHW Messmate (*Eucalyptus obliqua*) 200x 50mm

4.4.4 Bearers

Relatively protected similarly to the trimmer beam.

- F8 OBHW messmate (*Eucalyptus obliqua*) 100x75mm @ 1800 pacing

4.4.5 Joists

Relatively protected similarly to the trimmer beam

- F8 OBHW Messmate (*Eucalyptus obliqua*) 100x75mm @450c/c span 1800

4.4.6 Construction Details

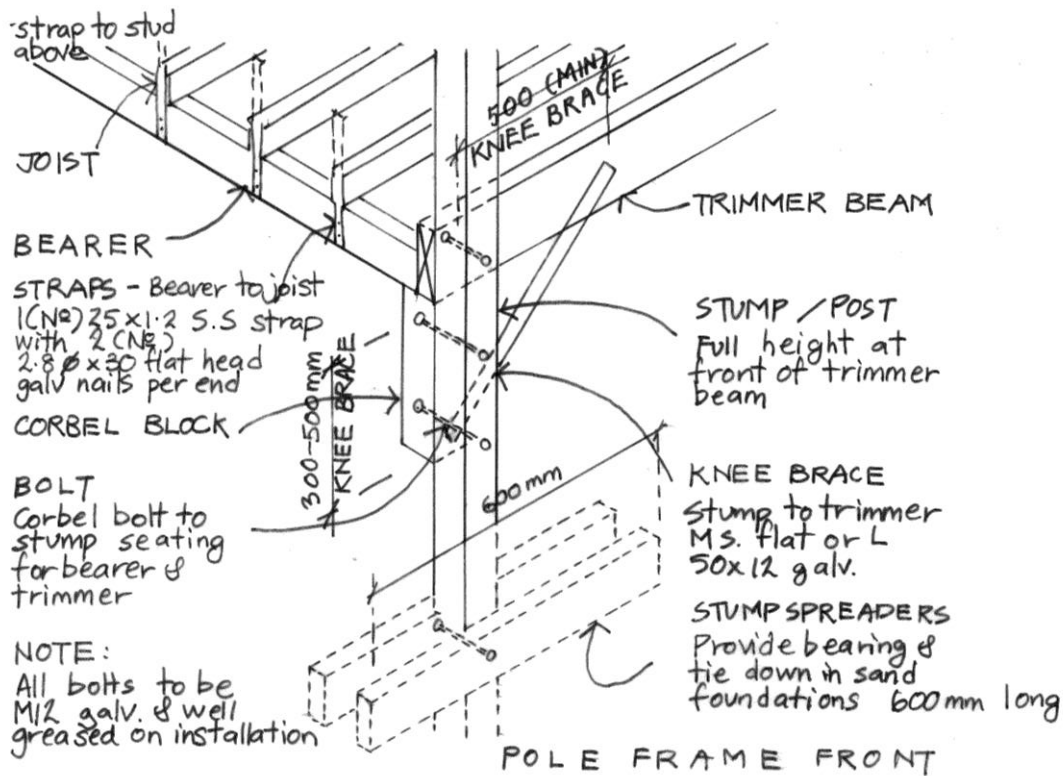
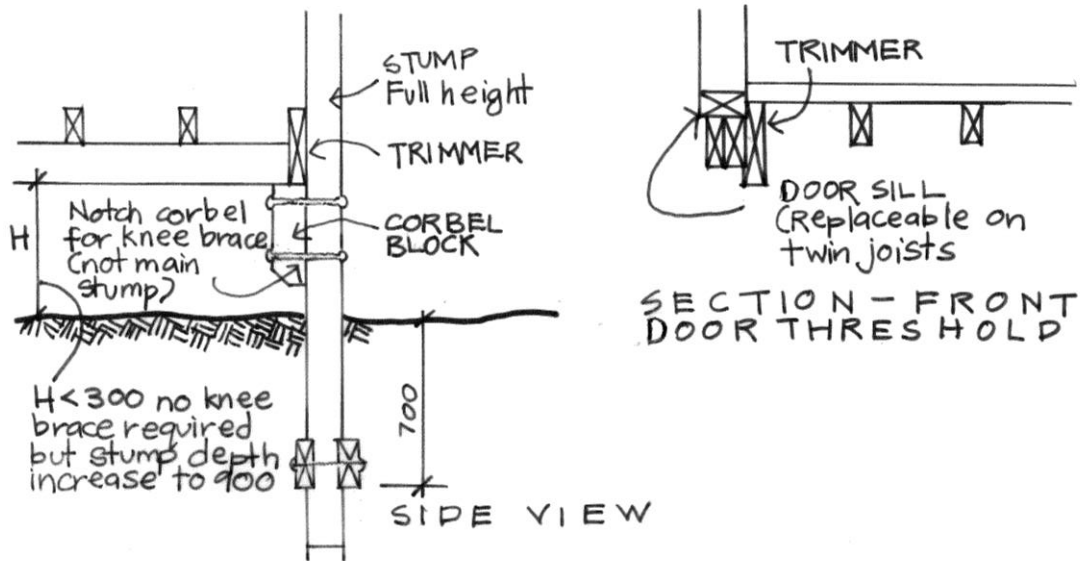

4.5 Roof

Roof battens	50 x 38 HW F8 @ 600 eave and ridge spans
Roof battens	50 x 38 HW F8 @ 900 internal spans
Rafter purlins bathing box	70 x 50 HW F8 @ 900 cc
Rafter purlins boatshed	100 x 50 HW F8 @ 900 cc
Ridge beam	
Bathing box (2400 span)	120 x 45 HW F8
Boatshed (6000 span)	190 x 45 HW F8

Materials

Roof framing consists of:

- Rafters (form the main structural component of the roof, carrying the load of the roof to the walls)
- Ridge beam (carries all loads of the upper half of the roof and serve as connecting point for rafter tops)
- Battens (provide connection between roof cladding and rafters)

4.5.1 Rafters

The rafters come in two sizes dependant on the building type.

- F8 OBMW Messmate (*Eucalyptus obliqua*).
- F7 LOSP treated Seasoned Radiata Pine (*Pinus radiata*)
 - 70x35 – for building width less than or equal to 2300mm
 - 90x35 – for building width greater than 2300mm

4.5.2 Ridge

The ridge beam carries much of the roof load and should be sized as follows:

- F8 OBHW Messmate (*Eucalyptus obliqua*)
- F7 LOSP treated Seasoned Radiata Pine (*Pinus radiata*) 150x25
- “Hyspan” Laminated Veneer Lumber

Building Width (m)	Length (m)	Ridge Beam Size
2	2.4	120x45
	3.0	140x45
	3.6	190x45
2.4	2.4	120x45
	3.0	140x45
	3.6	190x45
3.0	4.0	190x45
	3.0	190x45
	4.0	190x45
	5.0	240x45
	6.2	200x45*Hyspan LVL

4.5.3 Roof Battens

- F8 OBHW Messmate (Eucalyptus obliqua) 35x50@ 60 max spacing

4.5.4 Construction Details

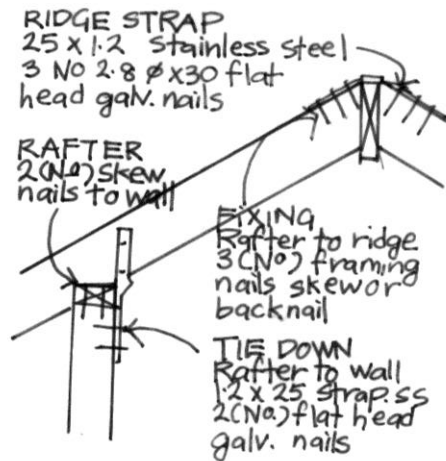

STRAPPING TO RAFTER

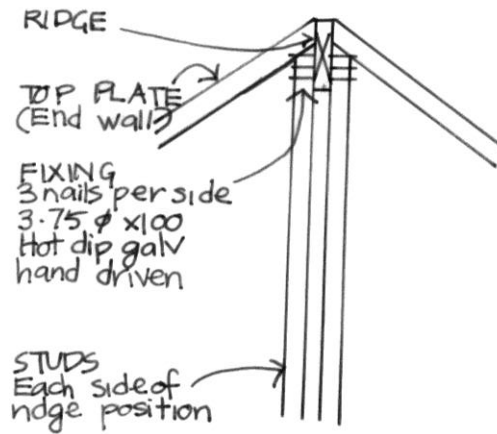

RIDGE TO END WALL

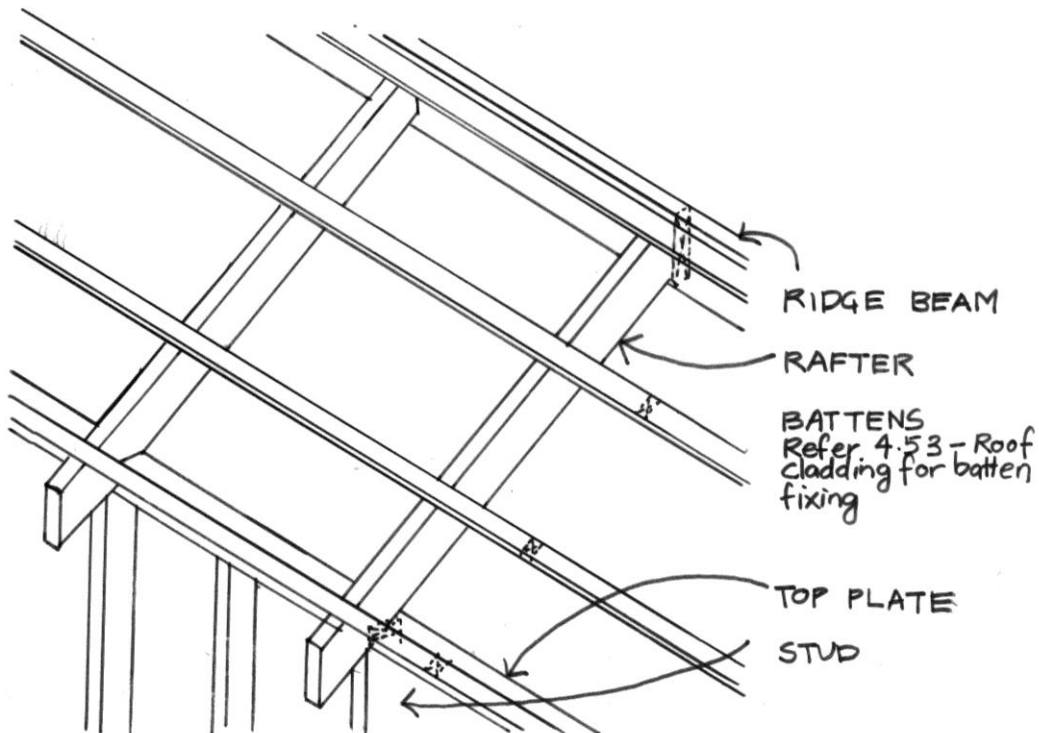

4.6 Claddings

Timber is to be used as the cladding material. Timber species and products have been selected for their availability, durability, price, and on the environmental impact of sourcing them.

For a more comprehensive analysis of the timbers, refer to 'Appendix B Timber' and to texts and advisory services listed in the Bibliography.

The timber claddings include:

- Flooring
- Wall Cladding
- Plinth board (which is the base board to the wall cladding) and plinth battens.

Timbers treatments are specified in conjunction with the timbers listed below.

4.6.1 Flooring Cladding

Internal floor lining is periodically subject to dampness and additional wear imposed by gritty sand.

Board Flooring

Solid timber tongue and groove floor boards.

- 20 mm thick seasoned Cypress Pine (*Callitris glauca*)

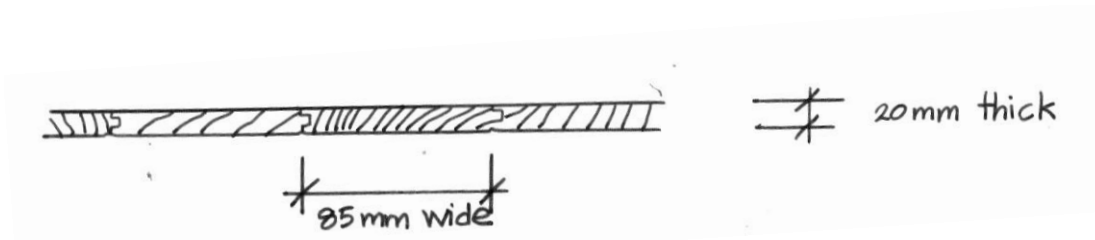

Plywood

Plywood is made up of thin glued layers of wood peeled from clear quality logs.

- F11 Radiata Pine (*Pinus radiata*)



Particleboard

Particleboard is made from chips from pine forest thinnings and waste, compressed and glued bonded into boards using phenolic resins.

- 19mm thick structural wet area particle board.
Fibre source Radiata Pine (*Pinus radiata*)

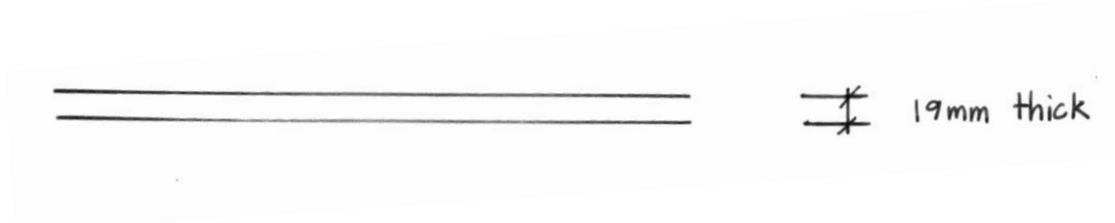

4.6.2 Wall Cladding

All timber, externally exposed, above floor level, including wall claddings, is to be painted.
(Refer to section 6. Finishing)

There are two types of timber cladding to be considered:

- Board cladding (which includes horizontal weatherboards and vertical board and batten lining)
- Sheet cladding (which can be grooved or plain with vertical battens)

Products that are visually similar to timber may be used as the cladding material for external walls.

Horizontal Board Cladding

Solid timber weatherboards overlapped to shed water:

- OSP treated redried Radiata Pine (*Pinus radiata*) Weatherboards

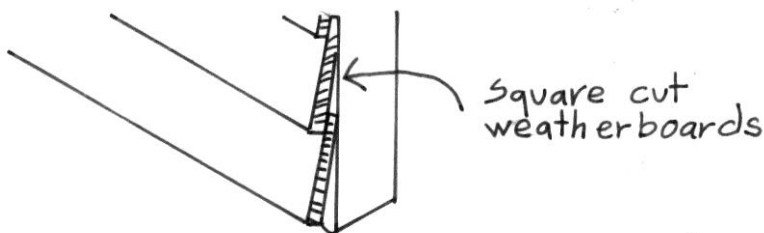

Vertical Board & Batten Cladding

This Comprises of:

- Wide thin boards (195 x 19 mm).
- Narrow thin battens (70 x 19mm).

This technique has historical significance being employed in construction of the very oldest Boatsheds still standing on Port Philip Bay.

- LOSP treated seasoned Radiata Pine (*Pinus radiata*)

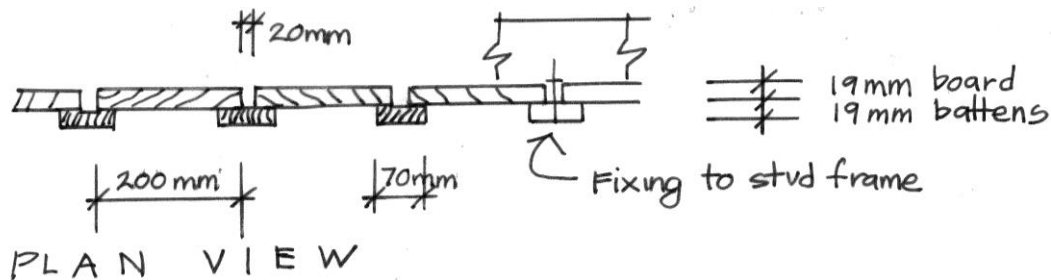

Plywood Sheet Cladding

Manufactured as per plywood flooring

Plywood wall sheeting can have a dual function as cladding and as bracing for walls.

- "Shadow clad" rough-saw face (grooved)-12mm thick
LOSP treated Radiata Pine (*Pinus Radiata*)
- "Texture 200" Rough-sawn face (plain)-12mm thick
LOSP treated Radiata Pine (*Pinus radiata*)

Plywood sheet with regularly spaced battens

By fixing 70 x 19mm battens at 200mm spacing over ungrooved "Texture 2000" plywood, the traditional board and batten effect can be achieved over a cladding system which also provides great lateral rigidity to the building structure.

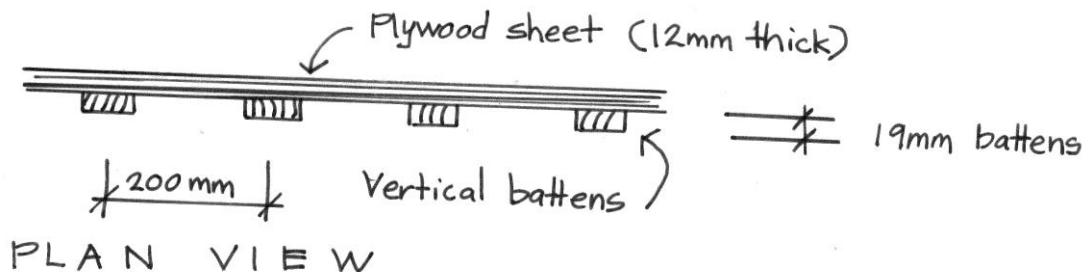

4.6.3 Plinth Board and Plinth Battens

The plinth board serves as the base board to wall cladding. The battens are regularly spaced boards below the plinth board connected to the stumps. Battens are optional. Many Bathing Boxes leave under floor space open.

For aesthetic reasons both plinth boards and battens (being timbers placed below the floor line) are to be left unpainted.

Both the plinth board and the battens may be in contact with the sand, therefore a more durable timber is required than for wall cladding.

- Plinth Board (150 x 25mm)
- Plinth battens (75 x 25mm)
 1. White Cypress Pine (*Callitris glauca*),

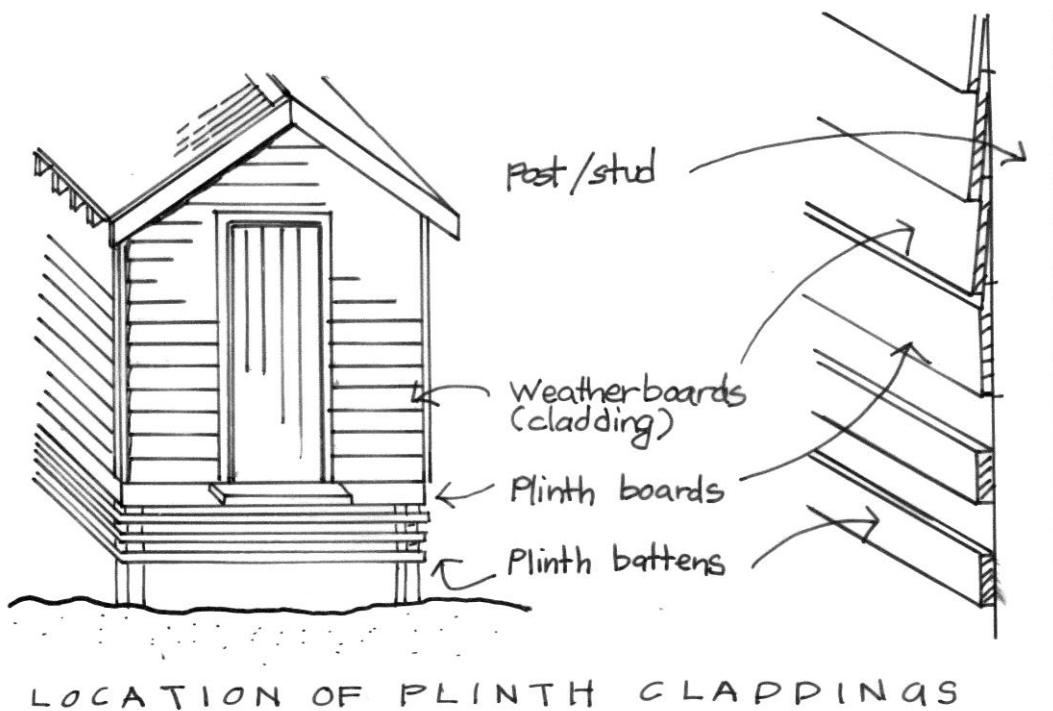

4.7 Openings

Openings to Bathing Boxes and Boatsheds include windows, shutters, vents and doors. Openings are to be framed in timber. Shutters are recommended in preference to glazed windows for safety reasons and to encourage the visual connection and social interaction between the licensee and the people on the beach. Timber components in openings are to be painted.

(Refer to Section 7 – Finished, for more information paint)

4.7.1 Frames

Frames include the door frames, windows frames and the shutter frames.

- LOSP treated seasoned finger jointed and laminated.
Radiata Pine (*Pinus radiata*)
- Seasoned Messmate (*Eucalyptus obliqua*)
(Solid section, structural grade dressed to size or Appearance grade dressed all round).

4.7.2 Shutters & Panels

- 20mm thick seasoned Cypress Pine (*Callitris columellaris*)
Tongue and groove boards
- 19mm LOSP seasoned Radiata pine (*Pinus radiata*)
Tongue and groove boards 140mm
Ready-made exterior shutters

4.7.3 Vents

Ready-made vents complete with frame and timber louvers are easiest option.

- Ready-made exterior wall vents
(Refer back to pages 8 and 10 for traditional location in gables)

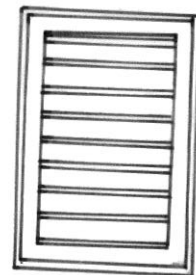
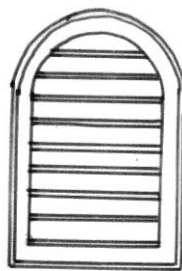
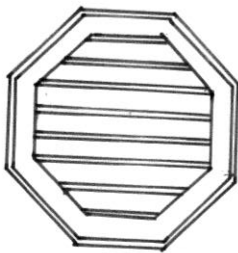

4.8 Threshold – Porch, Ramps & Decks

The term ‘threshold’ refers to all external timber structures that are separate from the building envelope (i.e. Decking, steps, ramps, porch, and bench seat). This timber must be durable as it is in contact with the ground and exposed to the elements.

4.8.1 Framing

The framing includes the stumps, posts, bearers and joists, which can all be built from the same timber species. The threshold is not to be painted but allowed to weather naturally.

Recommended materials include:

- F5 min the White Cypress Pine (*Callitris glauca*)

4.8.2 Decking

The Decking differs from the flooring in that there to be are gaps between boards to allow sand to fall through. The boards themselves can range in size from very wide to very narrow. Wide planks are suggested if the deck or steps are also to provide seating. In respect to the traditional aesthetic for Bathing Boxes and Boatsheds, the minimum thickness for the boards is 35mm.

- **Narrow Boards**

35 x 90mm (dressed)

38 x 100mm (rough sawn arris edged)

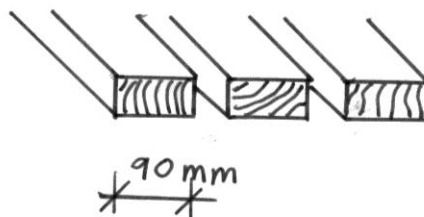

- **Broad boards**

35 x 245mm (dressed)

38 x 250mm (rough sawn arris edged)

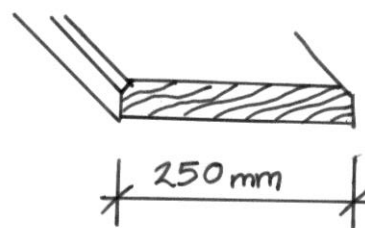

4.8.3 Treads and Stringers

The treads are the timber steps with the stringers rising alongside as support.

Try recycled red gum sleepers (dressed)

Ex 50x 250mm

Or 75 x 250mm

4.9 Roof Sheeting & Decoration

Corrugated steel sheeting is the most suitable and popular roof cladding material for Bathing Boxes and Boatsheds. Roof cladding comprises the sheeting, cappings and fixings. Gutters are not permitted, as they are unnecessarily vulnerable to vandalism and can concentrate rainwater discharge onto the beach which can contribute to sand erosion.

The front of the Bathing Box or Boatshed, in particular to the roof, provides opportunities for decoration (i.e. decorative fascia boards or finials)

4.9.1 Roof Sheeting

Zincalume

Zincalume is a sheet steel coated with Aluminium/Zinc alloy. Zincalume can be painted with water based acrylic paint if a diversity of colour is required. However it is difficult to achieve a durable and long lasting finish for the roof in this way. And, although painting Zincalume may seem less expensive than purchasing Colorbond, in terms of the initial outlay, the cyclical costs and workloads in painting and repainting will soon offset the apparent saving. Zincalume, as a raw product is an excellent material and its painted surface will wear at roughly the same as regular Colorbond. The price for corrugated Zincalume is about \$9/sqm

Colorbond XRW

Regular Colorbond is a pre-painted (oven-cured) sheet steel (with a Zincalume base coating). The paint does not give the Zincalume steel much added protection against corrosion. However, it is very resistant to chipping, cracking, peeling and fading. The price for corrugated Colorbond is approx. \$12/sqm.

Colorbond XSE

Ideal for severe marine environments. The sheet metal base is covered both sides with pure zinc and treated with a high build corrosion resistant paint (PVS-2) which provides a superior barrier against corrosion. It is more expensive than regular Colorbond. White is the cheapest alternative and is readily available. The price for corrugated Colorbond is around \$20/sqm for white and around \$30/sqm for other colours.

4.9.2 Capping

Capping material should be the same type of material and colour as the roof sheeting. Capping is used on roof gables and ridges as shown over page

4.9.3 Fixing

It is vital that the fasteners have the same service life as the cladding and the capping they are fixing. 40um hot dip galv. OR cast zinc-alloy heated screws. (Providing added protection for the coastal environment) can be used. Where colour match of fasteners is an overriding consideration, plastic headed fasteners (such as COLORFIX form Ajax Spurway) may be used. The Rubber washer screw seal also needs to be compatible. Washers containing a significant level of conductive carbon black filler are not suitable for use with steel roofing in marine environments.

Fasteners are to conform to Australian Standard AS3566 'Screws – Self –Drilling for the Building and Construction Industry' and be sold as such with the standard number.

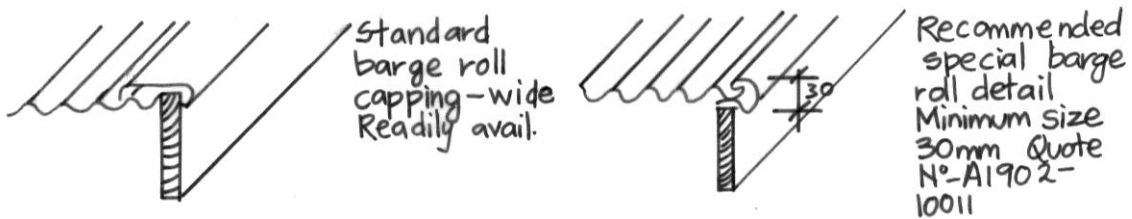

ROLL EDGE BARGE CAPPING



ROLL TOP RIDGE CAPPING

5. Decoration

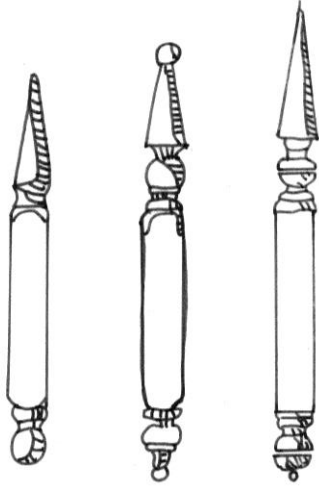

TYPES OF FINIALS

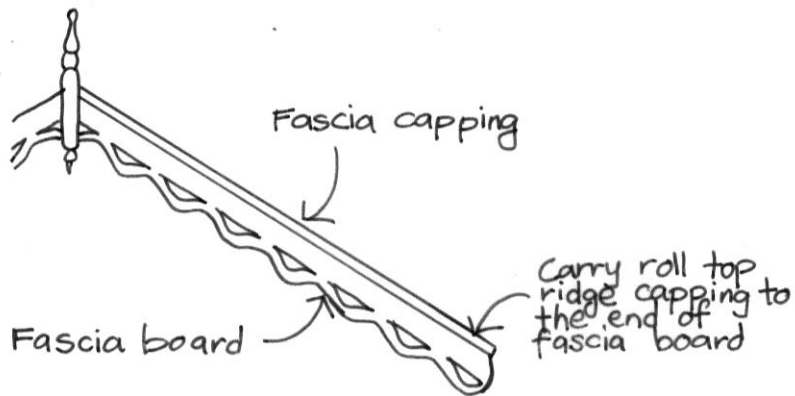

EXAMPLE OF GABLE END

6. Fasteners

Metals fastenings are used to connect the various components and materials in the buildings construction. The types of fastenings used are nails, screws, straps and bolts. Generally, hot-dipped galvanised steel is recommended for all of the fixings although there are other alternatives available.

(Refer to Appendix C - Metal for examples of other possible metal fixing materials).

6.1 Nails

Nails are usually mild steel and because of their high vulnerability to corrosion it is recommended that they always be hot dip galvanised. There are three main nail types used in the construction.

Framing Nails

Standard nails with bullet head used for general framing.

Flat head Nails

Flat head nails to provide the largest amount of surface contact area and gripping power and are used when exposure of the head is acceptable (e.g.: for fixing straps and wall cover battens).

Ribbed Shank Nails

Ribbed for greater gripping strength, (e.g.: for decking) Hot dip galvanised.

6.2 Screws

The threaded shaft on screws gives them greater holding and are particularly suitable for fastening roof sheeting (which may be subject to uplift) to the battens. Roof sheeting should always be screwed down to manufacturers specifications using proprietary steel base screw fixings. Screws can either be galvanised or cast zinc-alloy headed fasteners. Stainless steel screws are good for stainless steel hinges as are brass screws for brass hinges.

6.3 Straps

Straps tie the walls to the roof and the floor framing. They should be stainless steel because of their thin cross-section.

6.4 Bolts

Bolt nut and washer assemblies are to be used in connecting beams and posts.

7. Hardware Systems

Hardware refers to the hinges, catches, handles etc used for door and window furniture. All metal hardware should be hot dip galvanised steel, chrome plated steel or brass, or stainless steel. (Refer to Appendix B – Metals for further information into the durability of metals).

7.1 Hinges

Butt Hinges

Regular butt hinges are suitable for small openings. (2 per shutter)



Scotch T. Hinges

A stronger hinge which suits larger door panels and shutters and also looks appropriate on Bathing Boxes and Boatsheds.

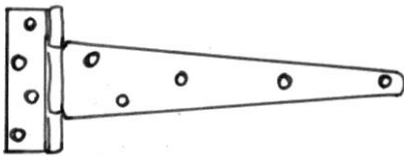

Heavy Duty Strap Hinge

The most robust hinge currently used on Boatsheds.

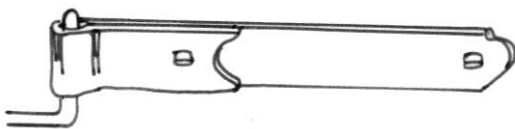

7.2 Catches and Locks

i. Hasp and Staple with padlocks

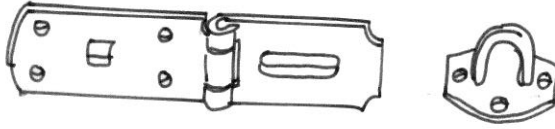

ii. Pad bolt

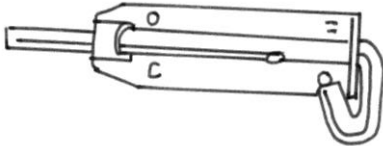

iii. Gate bolt



iv. Panic bolts



7.3 Handles

The choice of door handle is up to the licensee's discretion. Many Bathing boxes and Boatsheds have only a key operated latch which is used to pull the door closed. A simple door handle is a good idea for the side doors when used in conjunction with a night latch so the door can easily be pulled shut. A rope handle could serve the same purpose.

8. Finishing

Materials recommended throughout these Standards are durable in their own right and need not rely heavily on surface coatings which invariably have limited useful lives without regular maintenance for protection from the elements. And in this light, paint is best seen as a decorative medium, and not as a protective coating. (See also 'Section' – Construction Details, for appropriate materials). (Refer to manufacturers specifications for additional information regarding paints).

Flood coat all sawn ends and timber junctions with an approved sealing and water repellent preservative or oil based primer. Coat all extreme exposed surfaces with proprietary paint system suitable for marine exposure. Seal and cover all exposed timber ends.

Internal surfaces should be treated with sealer and preservation system. Note that CCA, ACQ or creosote preservative solutions are not acceptable.

8.1 Extent of Paintwork

The paint systems recommended for Bathing Boxes and Boatsheds have been selected for their aesthetic appeal. Separation of areas to be painted and areas to be left unpainted has been determined in the interests of heritage conservation.

- **Areas to be left unpainted**
Left unpainted, all timber regardless of species will weather to a silver grey colour
 1. All sub floor framing.
 2. Threshold (i.e. Deck, porch, ramp and steps)
 3. Cladding below floor level (i.e. plinth board and plinth battens)
- **Areas to be painted**
 1. Cladding above the floor level.
 2. Openings (e.g. Doors, shutters and vents).
 3. Decorative details (e.g. finials).
 4. Exposed rafter end, barges etc.

- **Areas free to be painted of left unpainted**
 5. Roof cladding
Note: If a painted finish is required, a pre-painted sheet cladding is recommended. (Refer to Section 3.5 – Roof Sheeting).
 6. Internal Surfaces.
 7. Floor paint is not recommended because of excessive wear. Oils and stains will wear better.
 8. All hardware.

8.2 Paint Selection

A low sheen paint is preferred to reduce glare and to fit in with current bay beach aesthetics. Enamel paints are discouraged because of their characteristic high sheen.

i Stains

Suitable stains are the heavily pigmented penetrating oils which supply strong colour whilst retaining the texture of the timber. They are suitable finishes for use on all exterior timbers. The stain pigments penetrate into the timber and provide a screen against degradation from ultra violet light. The stain oils also help to repel moisture. Moisture will cause cracking through swelling and shrinkage and encourages mould growth.

- **Preparation** – New or bare timber does not require priming or undercoating.
- **Finish** – the finish is very good, weathering to a matt powder finish. In time the surface gradually thins as chalky surface pigment dusts off.
- **Maintenance** – Lightly sand back before recoating to improve surface adhesion. Stains should be reapplied every 3 years.

ii Acrylic Paints

Low sheen

- **Preparation** – New or bare timber may require priming and/or undercoating.
- **Finish** – A low sheen finish is required. The coats develop a plastic film which is finished relatively thick and inflexible, therefore it will crack and peel in time.
- **Maintenance** – The finish is plastic like, therefore paint just needs to be washed down before repainting provided it hasn't been left to peel or crack. Paint may last up to 10 years but repainting is recommended every 5 years.
- **Clean up** – Acrylic paints are water based and clean up readily with water.

iii Cement Based Wash

Cement based washes are the result of a new technology striving for an environmentally friendly product, which has a traditional rich colours and soft texture together with good weather resistance. Cement based washes are more expensive than oil stains and acrylic paints, but have unique vibrant colours with subtle variation which gives an old style paint look.

Preparation – they require a low sheen acrylic as the basecoat to provide the

weather protection, with the colourful wash over. A primer will not be required unless the timber is already coated with paint of a different colour. Then a primer tinted to the colour of the wash will be required.

Finish – the finish is chalky and wears by gradual powdering.

Maintenance – as for stains, cement based washes require a light sand back before repainting because of the chalky surface. New coat require every 5 years approximately.

Clean up – Cement based paints are water based which makes for easy clean up.

8.3 Maintenance

To minimise labour intensive repainting which involves stripping and sanding back, it is best to regularly check paint surfaces. Fine cracks to the paint surface can be detected early and touched up before moisture finds its way in causing the paint to lift, promoting peeling and blistering to the surface. Carry out regular maintenance and repairs on all painted surfaces and exposed timber junctions.

i Prevention

A most effective way to ensure long life for a finishing system is to paint timber components before they are fixed into place. This gives an even coat to all surfaces of the timber and protects against warping and bowing.

Pay particular attention to treatment and sealing of end grains (i.e. The cut ends of member). (Refer to Appendix B – Timber – Durability)

9. Appendix A.

Bathing Boxes – Mount Martha North

(Bathing Box Numbers 92 to 151)

Construction Standards – Summary

The source document for this summary is a report titled: Design Guidelines for Bathing Boxes at Mount Martha North Beach – Final Report (13 September 2001), prepared by Coastal Engineering Solutions Pty Ltd in association with John Gardner & Associates for the Department of Natural Resources and Environment (now Department of Environment and Primary Industries).

(A) Rebuilt Bathing Box Construction Standards

- It is recommended that the underside of floor joists be located at 2.45m AHD or higher to account for predicted wave crest levels for a 50 year return period wave.
- If the underside of floor joists are to be lower than 2.45m AHD (but not less than 1m AHD) the floor is to be slatted (air gaps equivalent 15% of the floor area) to provide pressure relief for the uplift wave force.
- Where the underside of floor joists are located above 2.45m AHD there is no special requirement for the flooring.
- Piles are to be founded a minimum of 500mm into the sandy clay stratum below the beach sands and piles should have an allowable end pressure of 70 kPa (see attached design example Subfloor Framing – Drawing No. SK4.2).
- As a guide at least 33% of the length of the pile should be founded into the clay stratum below the beach sands.

OR

- Piles are to be founded to a depth into the sandy clay stratum below the beach sands so as to achieve an appropriate skin friction value and end pressure determined by a geotechnical engineer.
- Plinth boards are not permitted below the underside of floor joists.
Subfloor systems should use F8 (or higher stress grade) hardwood joists and bearers resulting in fewer piles and less wave impact area than would be achieved with lower stress grade F5 pine.
- Joist spacing of 450mm is recommended and the joists to run parallel to the waters edge to allow the bearers to be generally aligned with the wave action, reducing wave impact forces and drag on the bearers (see attached design example Subfloor Framing – Drawing No. SK4.1).
- All new bathing boxes are required to have a Building Permit issued by a Registered Building Practitioner in compliance with these construction standards and the Building Act and Regulations to the satisfaction of the Mornington Peninsula Shire and the Department of Environment and Primary Industries.

10. Appendix B. Timber

Timber Durability

Different timber species have been chosen for each of the constituent pieces of the building fabric based on their durability. Explanation of categories in durability follows.

Class 1

Timbers of the highest natural durability which may be expected to resist both decay and termite attack for at least 25 years and up to 50 years in the ground. For in ground applications.

- White Cypress Pine (*Callitris glauca*)

Soft wood increasingly harvested from Agroforestry plantations.

Watch out for sapwood (not greater than 10% of cross sectional area).

Durable native species are no longer readily available, therefore preservative treated plantation softwoods are recommended.

(See also *Timber Treatments*)

Class 2

“Timbers of high natural durability which would be expected to have a lifespan of about 15 to 25 years in ground.”

For external applications above ground unprotected from the weather.

Redgum (*Eucalyptus camaldulensis*)

Recycled timber takes the pressure off our native forests and the old growth timber has a naturally higher durability.

Durable native species are no longer readily available, therefore preservative treated plantation softwoods are recommended.

- Radiata Pine LOSP (*Pinus radiata*)
- Hoop Pine LOSP treated (*Araucaria cunninghamia*)

Class 3

Timbers of only moderate durability which may be expected to have a life of about 8 to 15 years in the ground.

For external application above ground protected.

- Messmate (*Eucalyptus obliqua*)

Hardwood with good durability and sourced from sustainable, managed Victorian forests.

Class 4

Timbers of low durability which may last from about 1 to 8 years in ground. These timbers have about the same durability as untreated sapwood which is generally regarded as Class 4, irrespective of species.

For internal applications only.

Foreign timber species:

- Radiata Pine untreated (*Pinus radiata*)

Native timber species:

- Mountain Ash (*Eucalyptus regnans*)
- Alpine Ash (*Eucalyptus delegatensis*)

The definitions for the timber classes above were taken from National Association of Forest Industries (NAFI) – Timber Species and Properties. For more information on timber refer to Bibliography.

Timber Treatments

In their natural state Radiata Pine and Hoop Pine are rated Durability Class 4. With the addition of preservative treatments, the durability of the timber is increased markedly.

LOSP treatment achieves durability equivalent to Class 2 timber.

Exposed end grain of timbers most readily accepts moisture and as such is most vulnerable to swelling and decay. It is recommended that all timber end grain exposed to moisture or ground contact be treated with a paint or preservative after cutting to size and prior to fixing in place.

LOSP treated timber

LOSPs (light organic solvent preservatives) are fungicides (copper, zinc, tin, or Pentachlorophenol), in a solution with an organic solvent such as white spirit. Where insect hazard is present, a suitable insecticide (synthetic pyrethoid), can be incorporated.

In addition to toxicants and solvents, most LOSP's contain waxes and resins which impart water repellence to the timber surface. LOSP's are not suitable for in- ground applications. Once treated, a post-treatment protection (e.g. An organic oil or non-toxic paint. Refer to Appendix C – Paint) can be applied. LOSP treated pine is also known as "DuraPine", "Vascol" Pine or "Protim" Pine.

11. Appendix C. Metal

Metal Types

The following metals used for fixing and hardware are listed in order of durability.

i Stainless Steel

This is by far the most durable metal available for fastenings and hardware for salty environments and thus the most desirable. Stainless Steel is also the most expensive, about 8 times the price of hot dip galvanised steel.

Although stainless steel is highly corrosion resistant in its own right, electrolytic action between dissimilar metals causes corrosion and so rules out stainless steel and stainless steel capped fasteners for use with Zinalume or Colorbond.

Stainless steel should be used for smaller hinges and for all strapping.

ii Hot Dip Galvanised Steel

Steel is literally dipped into molten zinc, which should make it very resistant to corrosion. The finish is matt and irregular. It is reasonably effective in a marine environment.

Hot dip galvanised steel should be used for all nails, larger hinges (heavy strap hinges and T-hinges) and robust locks etc.

iii Chrome Plated Steel

Chrome plated steel is ideal for hardware where hot dip galvanised is not suitable and stainless steel is too expensive. It is relatively durable depending on the quality of plating, although it will pit in time.

iv Zinc Plated Steel

Zinc plated is usually only very thin zinc coating on steel and is normally not very successful in protecting against rust in highly corrosive coastal environments. It is the least expensive option but also the least durable and therefore not recommended.

12. References

1. **Good Wood Guide** – The responsible and sustainable use of timber (8th Edition) David W. Low
Publisher: The Good Wood Advisory Centre, 1999
Available: The Friends of the Earth, T. (03) 9419 8700
2. **Forest & Wood Products Australia**
Downloadable files (extensive resource)
HYPERLINK "http://www.timber.org.au" www.timber.org.au
3. **Building Materials Energy and the Environment: Towards Ecologically Sustainable Development**
Bill Lawson
Publisher: The Royal Australian Institute of Architects, 2000
4. **Timber Advisory Centre**
1/180 Whitehorse Road
Blackburn, Vic, 3130
T. (03) 9875 5010
HYPERLINK "http://www.timber.asn.au/TAC/" www.timber.asn.au/TAC/

Publications available for purchase from TAC:

- AS 1684 Part 2 – 2006 Residential Timber Framed Construction Non-Cyclonic Areas - Standards Australia
- AS 1684 Part 4 – 2006 Residential Timber Framed Construction SIMPLIFIED - Non-Cyclonic Areas - Standards Australia
- Pocket Span Table Book
- The Australian Decks and Pergolas Building Manual, 5th Edition-Allan Staines
- The Australian Renovators Manual, 3rd Edition-Allan Staines
- The Australian Roof Building Manual, 4th Edition Enlarged-Allan Staines
- The Australian House Building Manual, 5th Edition Enlarged-Allan Staines
- How to be a successful Owner Builder and Renovator, 6th Edition-Allan Staines
- Wood in Australia (types, properties and uses)-Keith R. Bootle
- Timber Decks: Design and Construction Manual
- Timber Stairs, Balustrades and Handrails
- Timber Service Life Design package

5. The Plywood Association of Australasia Ltd.

3 Dunlop Street

Newstead, Qld, 4006

T. (07) 3854 1228

Publications available for download from HYPERLINK "<http://www.ewp.asn.au/>"

<http://www.ewp.asn.au/>

6. Australian Standards Association

HYPERLINK "<http://www.saiglobal.com/shop>" www.saiglobal.com/shop

AS 1684.1-1999

Residential timber-framed construction - Design criteria

AS 1684.1-1999/Amdt 1-2002

Residential timber-framed construction - Design criteria

AS 1684.2-2006

Residential timber framed construction - Non-cyclonic areas

AS 1684.2-2006/Amdt 1-2006

Residential timber framed construction - Non-cyclonic areas

AS 1684.4-2006

Residential timber-framed construction - Simplified - Non-cyclonic areas

AS 1684.4-2006/Amdt 1-2006

Residential timber-framed construction - Simplified - Non-cyclonic areas

AS 1170.0-2002

Structural design actions – General principles

AS 1170.2-2002

Structural design actions – Wind actions

AS 2796.1-1999

Timber - Hardwood - Sawn and milled products – Product specification

AS 2796.2-2006

Timber - Hardwood - Sawn and milled products - Grade description

AS 5604-2005

Timber - Natural durability ratings

AS/NZS 2269-2004

Plywood – Structural

AS/NZS 2272-1996

Plywood – Marine

AS/NZS 4357-1995
Structural Laminated Veneer Lumber

AS/NZS 2270-2006
Plywood and Blockboard for Interior Use

AS/NZS 2271-2004
Plywood and Blockboard for Exterior Use

AS 1720.1-1997
Timber Structures-Design methods

AS 3610-1995
Formwork for Concrete

AS 3566.1-2002
Self-drilling screws for the building and construction industries – General requirements and mechanical properties

7. **Bathing Boxes and Similar Structures around Port Phillip Bay:** A Report to the Minister for Planning and Environment, prepared by the Port Phillip Authority and The Heritage Unit, 1985

State Government of Victoria Department of Sustainability & Environment -
Library reference: 725.87099452 POR:B