

**REQUEST FOR BIDS
FOR
ORGANICS PROCESSING CENTER FLOOR REPAIR
AND OVERLAY.
ISSUED BY:**



**Humboldt Waste Management Authority
1059 West Hawthorne Street
Eureka, CA 95501**

October 20, 2023

Bid Opening: 3pm December 18, 2023

This Page Left Blank Intentionally

TABLE OF CONTENTS

	PAGE
NOTICE TO BIDDERS	vii
INSTRUCTIONS TO BIDDERS	ix
ARTICLE I - GENERAL CONDITIONS	
SECTION 1. PROPOSAL REQUIREMENTS AND GENERAL PROVISIONS	1
1-01. Definitions	
1-02. Examinations of Plans, Special Provisions and Site of Work	
1-03. Proposal	
1-04. Withdrawal of Bids	
1-05. Public Opening of Bids	
1-06. Bid Guaranty	
1-07. Qualification of Bidders	
1-08. Disqualification of Bidders	
1-09. Identification of Subcontractors	
1-10. General Provisions of the Standard Specifications	
SECTION 2. AWARD AND EXECUTION OF CONTRACT	5
2-01. Award of Contract	
2-02. Rejection of Bids	
2-03. Return of Proposal Guaranties	
2-04. Execution of Contract	
SECTION 3. SCOPE AND INTENT OF CONTRACT	6
3-01. Effect of Inspection and Payments	
3-02. Effect of Extension of Time	
3-03. Extra Work	
3-04. Assignment of Contract	
3-05. Subcontractors	
3-06. Interpretation of Special Provisions and Drawings	
3-07. Liability of HWMA Officials	
SECTION 4. BONDS	8
4-01. Faithful Performance Bond	
4-02. Material and Labor Bond	
4-03. Defective Material and Workmanship Bond	
4-04. Notification of Surety Companies	
SECTION 5. INSURANCE REQUIREMENTS FOR CONTRACTORS	9
5-01. Minimum Scope of Insurance	
5-02. Minimum Limits of Insurance	
5-03. Deductibles and Self-Insured Retentions	

- 5-04. Other Insurance Provisions
- 5-05. Acceptability of Insurers
- 5-06. Verification of Coverage
- 5-07. Subcontractors

SECTION 6. RESPONSIBILITIES AND RIGHTS OF CONTRACTOR..... 11

- 6-01. Legal Address of Contractor
- 6-02. Office of Contractor at Site
- 6-03. Attention to Work
- 6-04. Liability of Contractor
- 6-05. Protection of Persons and Property
- 6-06. Protection of HWMA Against Patent Claims
- 6-07. Protection of Contractor's Work Property
- 6-08. Regulations and Permits
- 6-09. Construction Utilities
- 6-10. Approval of Contractor's Plans
- 6-11. Suggestions to the Contractor
- 6-12. Termination of Unsatisfactory Subcontracts
- 6-13. Preservation of Stakes and Marks
- 6-14. Assistance to Project Engineer
- 6-15. Removal of Condemned Materials and Structures
- 6-16. Proof of Compliance with Contract
- 6-17. Errors and Omissions
- 6-18. Cooperation
- 6-19. Right of Contractor to Stop Work
- 6-20. Hiring and Dismissal of Employees
- 6-21. Wage Rates
- 6-22. Cleaning up
- 6-23. Guaranty

SECTION 7. RESPONSIBILITIES AND RIGHTS OF HWMA..... 16

- 7-01. Authority of the Engineer
- 7-02. Observation
- 7-03. Surveys
- 7-04. Rights-of-Way
- 7-05. Retention of Imperfect Work
- 7-06. Changes in the Work
- 7-07. Additional Drawings by HWMA
- 7-08. Additional and Emergency Protection
- 7-09. Suspension of Work
- 7-10. Right of HWMA to Terminate Contract
- 7-11. Use of Completed Portions

SECTION 8. WORKMANSHIP, MATERIALS AND EQUIPMENT..... 19

- 8-01. General Quality
- 8-02. Quality in Absence of Detailed Specifications
- 8-03. Materials and Equipment Specified by Name
- 8-04. Source of Materials
- 8-05. Storage of Materials
- 8-06. Drawings, Samples and Tests

SECTION 9. PROSECUTION OF WORK	20
9-01. Equipment and Methods	
9-02. Time of Completion	
9-03. Avoidable Delays	
9-04. Unavoidable Delays	
9-05. Notice of Delays	
9-06. Extension of Time	
9-07. Unfavorable Weather and Other Conditions	
9-08. Expected Hours	
9-09. Hours of Labor	
SECTION 10. PAYMENT	22
10-01. Certification by Engineer	
10-02. Progress Estimates and Payment	
10-03. Substitution of Securities	
10-04. Acceptance	
10-05. Final Estimate and Payment	
10-06. Delay Payments	
10-07. Extra Work and Work Omitted	
10-08. Compensation for Extra Work or Work Omitted	
10-09. Compensation to the HWMA for Extension of Time	
10-10. Liquidated Damages for Delay	
SECTION 11. MISCELLANEOUS	25
11-01. Notice	
11-02. Computation of Time	
11-03. Litigation and Forum Selection	
11-04. Waiver	
11-05. Bid Protest	

ARTICLE II - SPECIAL PROVISIONS AND TECHNICAL SPECIFICATIONS

SECTION 12. GENERAL INFORMATION..... 27

- 12-01. Arrangement of Technical Specifications
- 12-02. Arrangement of Project Specific Plans
- 12-03. Permits
- 12-04. Standard Specifications and Standard Plans
- 12-05. Temporary Facilities
- 12-06. Existing Utilities
- 12-07. Public Convenience and Safety
- 12-08. Cooperation
- 12-09. Dust/Fume Control
- 12-10. Stream Pollution
- 12-11. Notification of Underground Service Alert (USA)
- 12-12. Modification of the Standard Specifications

SECTION 13. MODIFICATIONS AND EXCLUSIONS FROM GENERAL CONDITIONS 30

- 13-01. Provisions to be Excluded from General Conditions

SECTION 14. AMENDMENTS TO GENERAL CONDITIONS 31

- 14-01. Provisions of General Conditions to be Amended

SECTION 15. CONSTRUCTION SPECIFICATIONS 32

- 15-01. Technical Specifications – Product Information
- 15-02. Drawings

SECTION 16. CONTRACT 33

- 16-01. Contract
- 16-02. Example Performance Bond
- 16-03. Example Material and Labor Bond
- 16-04. Direction for Bond Performance
- 16-05. Example of Maintenance Bond
- 16-06. Example Certificate of Insurance
- 16-07. Example Additional Insured Endorsement Form
- 16-08. Example Automobile Liability Special Endorsement Form
- 16-09. Example Worker’s Compensation and Employers’ Liability Special Endorsement Form

PROPOSAL FORMS, CERTIFICATES, AND DOCUMENTS (FOLLOWING TEXT)

PROPOSAL FORMS..... 43

Cover Page 44

Proposal 44

Bid Schedule 45

Fair Employment Practices Certification 47

Worker’s Compensation Certificate 48

Certificate of Nondiscrimination in Employment 49

List of Proposed Subcontractors 50

Statement of Experience of Bidder 51

Signature of Bidder 52

Bidder’s Bond 53

Non-Collusion Affidavit..... 54

End Page 55

Humboldt Waste Management Authority
NOTICE TO BIDDERS
FOR
Organics Processing Center Floor Repair and Overlay

NOTICE IS HEREBY GIVEN that sealed standard Proposals for the **Organics Processing Center Floor Repair and Overlay** will be received at the Humboldt Waste Management Authority (HWMA) Office at 1059 West Hawthorne St., Eureka, CA 95501 from bidders, **until 3:00pm Monday December 18, 2023**, at which time, or as soon thereafter as possible, the total bid amounts will be publicly opened and read. Bids shall be addressed to the Humboldt Waste Management Authority “**SEALED BID “Organics Processing Center Floor Repair and Overlay.”**” Bids are required for the entire work described herein. No electronic or fax bids will be accepted.

The work consists of installing a cementitious floor overlay on the existing asphaltic paving, replacing and installing new impervious berms, and waterproofing two existing sumps, all located within the household hazardous waste (HHW) building located at 1059 West Hawthorne Street in Eureka, California. The work also includes the mobilization, preparation of surfaces, demolition (as needed), labor, curing time, and cleanup related to the same.

Bid Documents and reference materials may be inspected and/or copies obtained at the Humboldt Waste Management Authority Office at 1059 West Hawthorne St., Eureka, CA 95501 for no fee by calling (707) 268-8680 and or viewed on-line at the HWMA website: <http://www.hwma.net>. **No bid will be considered unless it is made on the forms furnished by HWMA and is made in accordance with this bid package.** Each bidder must be licensed as required by law and as described in the Contract Documents.

The HWMA reserves the right to reject any or all bids or select the base bid plus any additive bid item or combination of additive bid items to determine which Proposal is, in its opinion, the lowest responsive bid of a responsible bidder and that which it deems in the best interest of the HWMA to accept. The HWMA also reserves the right to waive any information not material to cost or performance in any Proposal or bid.

Pursuant to provisions of Section 1770 et seq. of the Labor Code of the State of California, the Director of the Department of Industrial Relations, State of California, has ascertained the general prevailing rate of wages for straight time, overtime, Saturdays, Sundays and Holidays. Copies of the general prevailing wage determination applicable to the work is on file in the HWMA administrative offices and shall be made available to any interested party on request.

No contractor or subcontractor may be listed on a bid proposal for a public works project unless registered with the Department of Industrial Relations pursuant to Labor Code section 1725.5 (with limited exceptions from this requirement for bid purposes only under Labor Code section 1771.1(a)). No contractor or subcontractor may be awarded a contract for public work on a public works project unless registered with the Department of Industrial Relations pursuant to Labor Code section 1725.5. This project is subject to compliance monitoring and enforcement by the Department of Industrial Relations.

The prime contractor for the work herein shall possess a valid State of California, Class A (General Engineering), or Class C license(s) required to perform the described Work.

Pursuant to Section 22300 of the California Public Contract Code, this contract includes provisions that allow substitutions of certain types of securities in lieu of the HWMA withholding a portion of the partial payments due the Contractor to insure performance under this contract.

Dated: April 14, 2023

Eric Keller-Heckman
Executive Director
Humboldt Waste Management Authority

INSTRUCTIONS TO BIDDERS

HWMA **Organics Processing Center Floor Repair and Overlay** shall be performed in accordance with the Plans and Special Provisions included herein.

Each bidder must supply all the information required by the Proposal Forms, Certificates and Documents and the Special Provisions.

Minority business enterprises will be afforded full opportunity to submit bids in response to this invitation and will not be discriminated against on the grounds of race, color or national origin in consideration for an award of any contract entered into pursuant to this advertisement.

Women will be afforded equal opportunity in all areas of employment. However, the employment of women shall not diminish the standards of requirements for the employment of minorities.

All Proposals or bids shall be accompanied by a cashier's check or certified check payable to the order of Humboldt Waste Management Authority (HWMA) amounting to 10 percent of the bid, or by a bond in said amount and signed by the bidder and a corporate surety, payable to HWMA. Said check shall be forfeited, or said bond shall become payable to HWMA in the event the bidder depositing the same does not, within fifteen (15) days after written notice that the contract has been awarded to it: (a) enter into a contract with the HWMA and (b) furnish certificates of insurance and endorsements, a bond of faithful performance and a payment bond as described in the Special Provisions.

No bidder shall withdraw his or her bid for a period of thirty (30) calendar days after the date set by the HWMA for the opening thereof.

The Contractor shall furnish a project schedule to the Project Engineer prior to the start of any work and start work as scheduled.

The work shall commence following receipt of notice that the contract has been executed by the HWMA at a mutually agreed to time and all substantial work must be completed by within 90 days of authorization to proceed. Time of completion and the amount of liquidated damages are described in Article 1 of the Contract.

Examination of Site, Drawings, Etc.

Each bidder shall visit the site of the proposed work and fully acquaint him or herself with local conditions, construction and labor required so that he or she may fully understand the facilities, difficulties and restrictions attending the execution of the work under the Contract. Bidders shall thoroughly examine and be familiar with all Plans and Specifications. The failure of any bidder to receive or examine any form, instrument, addendum, or other document, or to visit the site and acquaint him or herself with conditions there existing shall in no way relieve the bidder from any obligation with respect to his or her Proposal or to the contract. The drawings for the work show conditions as they are supposed or believed by the Engineer to exist; but, it is neither intended nor shall it be inferred that the conditions as shown thereon constitute a representation by the Engineer, the HWMA or its officers that such conditions are actually existent; nor shall the HWMA, the Project Engineer or any of their officers or representatives be liable for any loss sustained by the Contractor as a result of a variance between the conditions shown on the drawings and the conditions actually revealed during the progress of the work or otherwise.

The bidder's attention is directed to the possible existence of obstructions and public improvements within the limits of the work or adjacent thereto, which may or may not be shown on the Drawings.

The bidder shall investigate to his or her satisfaction the conditions to be encountered, the character, quality and quantities of work to be performed and materials to be furnished and the requirements of the Plans, Special Provisions, Standard Specifications, Standard Plans, and Contract Documents. The submission of a Proposal shall be considered conclusive evidence that the bidder has made such examination and has accepted the project workplace as a safe workplace to perform the work of the Contract.

Bidders List/Addenda

It is the responsibility of all prospective bidders to contact the Executive Director and have their contact information added to the "Prospective Bidders List." Only bidders that are on the Bidders List will be sent addenda. Bidders must acknowledge all addenda in their Proposal. Please call or e-mail the Executive Director to be added to the Bidders List.

Attn: Executive Director
Humboldt Waste Management Authority
Phone: 707 268-8680
Email: ekeller@hwma.net

All questions shall be submitted in writing to the Executive Director by email no later than **4:00 PM Wednesday, November 22, 2023**

Site Visit

To schedule a site visit, bidders shall contact Anthony Heacock Director of Environmental Health and Safety, at (707) 268-8680, at least three (3) business days before arriving at the site and arrange a date and time to coordinate a site visit. Site visits are optional, and must be conducted no later than **Wednesday, November 15, 2023**. The facility is located at 1059 West Hawthorne Street, Eureka, California.

Evaluation of Bids

Only responsive bids from responsible bidders will be reviewed. Because unit prices are key elements of bid award and contract administration, in the event of a discrepancy between the unit price and the total amount, when unit prices are requested, the unit price shall prevail. If, however, the unit price is omitted, ambiguous, unintelligible or uncertain for any reason, or if it is the same amount as set forth in the Amount column, then the Amount shall prevail and will be divided by the estimated quantity to determine a unit price. The bids will be compared on a total bid price basis as a sum of all unit prices multiplied by their respective and related quantities. The HWMA will select the lowest responsible bidder. In case of a tie, the HWMA will select the bidder that it feels best serves the HWMA's interests.

ARTICLE I -- GENERAL CONDITIONS

SECTION 1. PROPOSAL REQUIREMENTS AND GENERAL PROVISIONS

1-01. Definitions. Whenever any word or expression defined in this section, or pronoun used in its stead, occurs in these Contract Documents, it shall have and is mutually understood to have the meaning given:

- a. "Contract" shall mean the written agreement between the Contractor and HWMA to perform the work listed in the Contract Documents.
- b. "Contract Documents" shall mean the General Conditions, Special Provisions and Technical Specifications, Plans, Proposal and Contract.
- c. "Contract drawings", "Drawings", "Plans" shall mean and include 1) all drawings or plans which may have been prepared by or on behalf of the HWMA, as a basis for Proposals, when duly signed and made a part of the Contract Documents by incorporation or reference, 2) all drawings submitted in performance of the Contract terms by the successful bidder with his or her Proposal and by the Contractor to the HWMA if and when approved by the Project Engineer and 3) all drawings submitted by the Project Engineer to the Contractor during the progress of the work as provided for herein.
- d. "Contractor" shall mean the party entering into the Contract with the HWMA for the performance of work covered by the Contract Documents and his or her authorized agents or legal representatives.
- e. "Date of signing of Contract" or words equivalent thereto, shall mean the date upon which the Contract, with the signature of the Contractor and HWMA affixed, together with the prescribed bonds, shall be or shall have been delivered to the HWMA or its duly authorized representatives.
- f. "Day" or "days", unless herein otherwise expressly defined, shall mean a calendar day or days of twenty-four hours each.
- g. "Project Engineer" shall mean a licensed practicing Engineer (or Engineering Geologist, as applicable the specific work) officially appointed by the HWMA to monitor the work described in the Contract Documents and related activity, acting personally or through agents or assistants duly authorized by them, such agents or assistants acting within the scope of the particular duties entrusted to them.
- h. "Humboldt Waste Management Authority" or "HWMA" shall mean the Humboldt Waste Management Authority, acting through its Board any other board, body, official or officials to which or to whom the power belonging to the Board shall by virtue of any act or acts, hereafter pass or be held to appertain.
- i. "Owner" shall mean the Humboldt Waste Management Authority or HWMA.
- j. "Proposal" shall mean all completed forms submitted by the bidder to HWMA in response to the Notice to Bidders.
- k. "Special Provisions" shall mean the Special Provisions and Technical Specifications Article of the Contract Documents that addresses special specifications that bidders must adhere to in submitting their bid documents.
- l. "Standard Specifications" is defined in Section 12.04 of the Special Provisions.
- m. "The work" shall mean and include all the work specified, indicated, shown or contemplated in the Contract Documents to construct the improvement, including all alterations, amendments or extensions thereto made by Contract change order or other written orders of the Project Engineer.
- n. Where "as shown", "as indicated", "as detailed" or words of similar import are used, it shall be understood that reference to the drawings accompanying the Special Provisions is made unless stated otherwise.
- o. Where "as directed", "as permitted", "approved" or words of similar import are used, it shall be understood that the direction, requirements, permission, approval or acceptance of the Project Engineer is intended unless stated otherwise.
- p. As used herein, "provide" or "install" shall be understood to mean "provide or install complete in place", that is, "furnish and install". "Shall" is mandatory; "may" is discretionary.

1-02. Examination of Plans, Special Provisions and Site of Work. The bidder shall examine carefully the Proposal, Plans, Special Provisions, Proposal forms and the site of the work contemplated therefore. It will be assumed that the bidder has investigated to his or her satisfaction the conditions to be encountered and the character, quality and requirements of all Plans, Special Provisions, Standard Specifications, and Standard Plans involved.

1-03. Proposal. Bids shall be made on the blank Bid Schedule form included in the Proposal Forms portion of this invitation. All bids shall give the prices bid, both in writing and in figures and shall be signed by the bidder or his or her authorized representative, with his or her address. If the bid is made by an individual or partner, his or her name and the post office address of his or her business or partnership, along with his or her signature or the signature of one or more partners must be shown; if made by a corporation, the bid shall show the name of the state under the laws of which the corporation is chartered, the name of the corporation and the title of the person who signs on behalf of the corporation. Proposal forms may not be altered (except as needed to fill them out), must be complete, and all proposal forms must be returned.

Each Proposal shall be enclosed in a sealed envelope, endorsed as specified in the notice to bidders. Bidders are warned against making erasures or alterations of any kind. Proposals that contain omissions, erasures, conditions, alterations, additions not called for, additional Proposals or irregularities of any kind may be rejected.

1-04. Withdrawal of Bids. Any bid may be withdrawn at any time prior to the hour fixed in the notice to bidders for the openings of bids, provided that a request in writing, executed by the bidder or his or her duly authorized representative, for the withdrawal of such bid is filed with the HWMA. The withdrawal of a bid will not prejudice the right of a bidder to file a new bid.

1-05. Public Opening of Bids. Bids will be opened and the bid amounts read publicly at the time and place indicated in the notice to bidders. Bidders or their agents are invited to be present.

1-06. Bid Guaranty. Each bid must be accompanied by a certified check, cashier's check or bidder's bond executed by an admitted surety insurer with an A.M. Best Financial Strength Rating of A- or better, payable to the order of the HWMA in an amount not less than 10 percent of the bid as a guarantee that the bidder will enter into a contract, if awarded the work.

1-07. Qualification of Bidders. Each bidder shall be licensed under the provisions of Chapter 9, Division 3 of the Business and Professions Code and shall be skilled and regularly engaged in the general class or type of work called for under this contract. No contractor or subcontractor may be listed on a bid proposal for a public works project unless registered with the Department of Industrial Relations pursuant to Labor Code section 1725.5 (with limited exceptions from this requirement for bid purposes only under Labor Code section 1771.1(a)) No contractor or subcontractor may be awarded a contract for public work on a public works project unless registered with the Department of Industrial Relations pursuant to Labor Code section 1725.5.

1-08. Disqualification of Bidders. More than one bid from an individual business, partnership, corporation or association, under the same or different names, will not be considered. Reasonable grounds for believing that any bidder is financially interested in more than one bid for the work will cause the rejection of all bids in which he or she is so interested. If there is reason to believe that collusion exists among the bidders, none of the participants in such collusion will be considered. Bids in which the prices obviously are unbalanced may be rejected.

1-09. Identification of Subcontractors. All bids shall comply with the Subletting and Subcontracting Fair Practices Act (Government Code Section 4100 and following) and shall set forth:

- (a) The name and the location of the place of business, the California contractor license number, and public works contractor registration number issued pursuant to Section 1725.5 of the Labor Code of each subcontractor who will perform work or labor, or render service to the prime contractor in or about the construction of the work or improvement, or to a subcontractor licensed by the State of California who, under subcontract to the prime contractor, specially fabricates and installs a portion of the work according to detailed drawings contained in the Plans and Special Provisions, in an amount in excess of one-half of 1 percent of the prime contractor's total bid.
- (b) The portion of the work that will be done by each such subcontractor. The prime contractor shall list only one subcontractor for each such portion defined by the prime contractor in his or her bid.

- (c) An inadvertent error in listing the California contractor license number or public works contractor registration number provided pursuant to paragraph (1) shall not be grounds for filing a bid protest or grounds for considering the bid nonresponsive if the corrected contractor's license number is submitted to the public entity by the prime contractor within 24 hours after the bid opening and provided the corrected contractor's license number corresponds to the submitted name and location for that subcontractor.
- (d) Subject to subitem (c) above, any information requested by the officer, department, board, or commission concerning any subcontractor who the prime contractor is required to list under this subdivision, other than the subcontractor's name, location of business, the California contractor license number, and the public works contractor registration number, may be submitted by the prime contractor up to 24 hours after the deadline established by the officer, department, board, or commission for receipt of bids by prime contractors.

1-10. General Conditions to Include Provisions of California Standard Specifications. All provisions of the General Provisions, Sections 1 through 9, of the California Standard Specifications, are hereby incorporated into these General Conditions except as specifically modified or excluded by the Special Provisions.

SECTION 2. AWARD AND EXECUTION OF CONTRACT

2-01. Award of Contract. Award of the Contract, if it be awarded, will be to the lowest responsible bidder whose bid complies with all the specified requirements. The award, if made, will be made within ninety (90) days after opening of the bids. The HWMA or its Executive Director reserves the right to select the base bid plus additive bid item or accumulation of additive and bid items.

2-02. Rejection of Bids. The HWMA in its discretion may reject a bid that shows any alteration of form, additions not called for, conditional bids, incomplete bids, erasures or irregularities of any kind; or may, waive any immaterial defect or irregularity in bidding. Bids in which the price of any item appears abnormally high or low may also be rejected. Further, the HWMA reserves the right to reject all bids.

2-02. Return of Proposal Guaranties. All bid guaranties will be held until the Contract has been fully executed, after which they will be returned to the respective bidders whose bids they accompany.

2-03. Execution of Contract. The Contract shall be executed in duplicate by the successful bidder and returned, together with the bonds, insurance certificates and endorsements, within fifteen (15) days after written notice of the award of the Contract. After execution by the HWMA, one original shall be filed with the HWMA and one original shall be returned to the Contractor. If the bidder fails or refuses to enter into the Contract within the required time, then the bid guaranty accompanying the bid shall be forfeited to the HWMA.

SECTION 3. SCOPE AND INTENT OF CONTRACT

3-01. Effect of Inspection and Payments. Neither the inspection by the Project Engineer or an inspector, nor any order, measurement or approved modification, nor certificate or payment of money, nor acceptance of any part or whole of the work, nor any extension of time, nor any possession by the HWMA or its agents, shall operate as a waiver of any provision of the Contract Documents or of any power reserved therein to the HWMA, or of any right to damages thereunder; nor shall any breach of the Contract be held to be a waiver of any subsequent breach. All remedies shall be construed as cumulative.

3-02. Effect of Extension of Time. The granting of any extension of time on account of delays that, in the judgment of the HWMA, are avoidable delays shall in no way operate as a waiver on the part of the HWMA of its rights under the Contract.

3-03. Extra Work. If extra work orders are given in accordance with provisions of the Contract Documents, such work shall be considered a part hereof and shall be subject to each and all of its terms and requirements.

3-04. Assignment of Contract. The Contract may be assigned or sublet in whole or in part only upon the written consent of the HWMA acting through its authorized agents. Consent will not be given to any proposed assignment that would relieve the original contractor or its surety of their responsibilities under the Contract nor will the Project Engineer consent to any assignment of a part of the work under the Contract.

3-05. Subcontractors. The Contractor shall be as fully responsible for the acts and omissions of his or her subcontractors and of persons either directly or indirectly employed by them, as he or she is for the acts and omissions of persons directly employed by him.

Each subcontractor shall be obligated to Contractor and the HWMA in the same manner and to the same extent as Contractor is obligated to the HWMA under the Contract. The Contractor shall cause appropriate provisions to be inserted in all subcontracts relative to the work to bind subcontractors to the terms of this Contract that are applicable to the work of subcontractors. If hiring a sub-subcontractor to perform any Work, the subcontractor shall include in the subcontract all provisions of the Contract Documents including all insurance and indemnity provisions that are applicable to said subcontractor's scope of work.

Contractor shall furnish a copy of the Contract insurance and indemnity provisions to any subcontractor upon request. Upon request from the HWMA, Contractor shall provide insurance certificates and endorsements of its subcontractors.

Nothing contained in the Contract shall be construed to create or shall be relied upon to create any contractual relationship between any subcontractor and the HWMA and no action may be brought by any subcontractor against the HWMA based on this Contract.

3-06. Interpretation of Special Provisions and Drawings. The Special Provisions and the Contract Drawings are intended to be explanatory of each other. Any work indicated in the Contract Drawings and not in the Special Provisions, or vice versa, is to be executed as if indicated in both. In case of a discrepancy or conflict between the Technical Specifications of the Special Provisions and Contract Plans, the Technical Specifications shall govern. All work shown on the Contract Drawings, the dimensions of which are not figured, shall be accurately followed to the scale to which the drawings are made, but figured dimensions are in all cases to be followed, where given, though they differ from scaled measurements. Large scale drawings shall be followed in preference to small scale drawings. Should it appear that the work to be done, or any of the matters relative thereto, are not sufficiently detailed or explained in these contract documents, including the contract drawings, the Contractor shall apply to the Project Engineer for such further explanations as may be necessary and shall conform thereto as part of the work, so far as may be consistent with the Contract Documents. In the event of any doubt or questions arising respecting the true meaning of the Special Provisions, reference shall be made to the Project Engineer and his or her decision thereon shall be final. If the Contractor believes that a clarification or interpretation justifies an increase in the contract price or contract time, the Contractor must comply with the written notice provisions of Sections 9-05 and 10-07 of these General Provisions. Contractor's attention is directed to Section 12-04 of the Special Provisions and Technical Specifications regarding the Standard Specifications and Standard Plans.

3-07. Liability of HWMA Officials. Neither HWMA, nor its officials, officers, employees, agents or contractors, including but not limited to the Project Engineer, nor any authorized assistant of any of them, shall be personally responsible for any liability arising under the Contract.

SECTION 4. BONDS

4-01. Faithful Performance Bond. As a part of the execution of the Contract, the Contractor shall furnish a bond of an admitted surety company, with an A.M. Best Financial Strength Rating of A- or better, or other securities providing equivalent protection such as cash, letter of credit, or certificates of deposit, acceptable to the HWMA, conditioned upon the faithful performance of all covenants and stipulations under this contract. The amount of the bond shall be 100 percent of the total Contract price, as this sum is set forth in the Contract.

4-02. Material and Labor Bond. As a part of the execution of the Contract, the Contractor shall furnish a bond of a surety company, with an A.M. Best Financial Strength Rating of A- or better, or other securities providing equivalent protection such as cash, letter of credit or certificates of deposit acceptable to the HWMA in a sum not less than 50 percent of the total Contract price, as this sum is set forth in the Contract for the payment in full of all persons, companies or corporations who perform labor upon or furnish materials to be used in the work under this contract, in accordance with the provisions of Sections 3247 through 3252 inclusive of the Civil Code of the State of California and any acts amendatory thereof.

4-03. Defective Material and Workmanship Bond. As a condition precedent to the completion of work, the Contractor shall furnish a bond of a surety company acceptable to the HWMA in an amount not less than 15 percent (15%) of the total contract price, to hold good for a period of one (1) year after the completion and acceptance of the work, to protect the HWMA against the results of defective materials, workmanship and equipment during that time. This bond shall be delivered to the HWMA before the final payment under this contract will be made.

4-04. Notification of Surety Companies. The surety companies shall familiarize themselves with all of the conditions and provisions of the Contract Documents and they waive the right of special notification of any change or modification of the Contract or of extension of time, or decreased or increased work, or of the cancellation of the Contract, or of any other act or acts by the HWMA or its authorized agents, under the terms of the Contract; and failure to so notify the aforesaid surety companies of changes shall in no way relieve the surety companies of their obligation under the Contract.

SECTION 5. INSURANCE REQUIREMENTS FOR CONTRACTORS

Contractor shall procure and maintain for the duration of the Contract, insurance against claims for injuries to persons or damages to property which may arise from or in connection with the performance of the work hereunder by the Contractor, his or her agents, representatives, employees or subcontractors.

5-01. Minimum Scope of Insurance

Coverage shall be at least as broad as:

1. Insurance Services Office Commercial Liability Coverage (occurrence form CG 0001, or the exact equivalent).
2. Insurance Services Office form number CA 0001 (Ed. 1/87) covering Automobile Liability, code 1 (any auto), or the exact equivalent.
3. Worker's Compensation insurance as required by the State of California and Employer's Liability Insurance.

5-02. Minimum Limits of Insurance

Contractor shall maintain limits no less than:

1. General Liability: \$2,000,000 per occurrence for bodily injury, personal injury and property damage. If Commercial General Liability Insurance or other form with a general aggregate limit is used, either the general aggregate limit shall apply separately to this project/location or the general aggregate limit shall be twice the required occurrence limit.
2. Automobile Liability: \$1,000,000 per accident for bodily injury and property damage.
3. Employer's Liability: \$1,000,000 per accident for bodily injury and property damage.

5-03. Deductibles and Self-insured Retentions

Any deductibles or self-insured retentions must be declared to and approved by the HWMA. At the option of the HWMA, either: the insurer shall reduce or eliminate such deductibles or self-insured retentions as respects the HWMA, and its officers, officials, agents, employees, contractors and volunteers; or the Contractor shall provide a financial guarantee satisfactory to the HWMA guaranteeing payment of losses and related investigations, claim administration and defense expenses.

5-04. Other Insurance Provisions

The general liability and automobile liability policies are to contain, or be endorsed to contain, the following provisions:

1. The HWMA and its officers, officials, agents, employees, contractors and volunteers are to be covered as additional insureds with respect to liability arising out of automobiles owned, leased, hired or borrowed by or on behalf of the contractor; and with respect to liability arising out of work or operations performed by or on behalf of the Contractor including materials, parts or equipment furnished in connection with such work or operations. General liability coverage can be provided in the form of an endorsement to the Contractor's insurance, or as a separate owner's policy.
2. For any claims related to this project, the Contractor's insurance coverage shall be primary insurance as respects the HWMA and its officers, officials, agents, employees, contractors or volunteers. Any insurance or self-insurance maintained by the HWMA and its officers, officials, agents, employees or volunteers shall be excess of the Contractor's insurance and shall not contribute with it.

3. Each insurance policy required by this clause shall be endorsed to state that coverage shall not be canceled by either party, except after thirty (30) days' prior written notice by certified mail, return receipt requested, has been given to the HWMA.

Course of construction policies shall contain the following provisions:

1. The HWMA shall be named as loss payees.
2. The insurer shall waive all rights of subrogation against the HWMA.

5-05. Acceptability of Insurers

Insurance is to be placed with insurers with a current A.M. Best's rating of no less than the following:

A++ VII	A VII
A+ VII	A- VIII

5-06. Verification of Coverage

Contractor shall furnish the HWMA with original certificates and amendatory endorsements affecting coverage required by this clause. The endorsements shall be on forms provided by the HWMA or on other than the HWMA's forms, provided those endorsements or policies conform to the requirements. All certificates and endorsements are to be received within 10 days from written notice of contract award, and the work shall not commence until the certificates and endorsements have been approved by the HWMA. The HWMA reserves the right to require complete certified copies of all required insurance policies, including endorsements affecting the coverage required by these Special Provisions at any time.

5-07. Subcontractors

Contractor shall include all subcontractors as insured under its policies or shall furnish separate certificates and endorsements for each subcontractor. All coverages for subcontractors shall be subject to all of the requirements stated herein. Contractor shall furnish a copy of the Contract insurance and indemnity provisions to any subcontractor upon request. Upon request from the HWMA, Contractor shall provide insurance certificates and endorsements of its subcontractors.

SECTION 6. RESPONSIBILITIES AND RIGHTS OF CONTRACTOR

6-01. Legal Address of Contractor. Both Contractor's address given in the Proposal and the Contractor's office in the vicinity of the work are hereby designated as places to which drawings, samples, notices, letters or other articles or communications to the Contractor may be mailed or delivered. The delivery at either of these places of any such thing from the HWMA or its agents to the Contractor shall be deemed sufficient service thereof upon the Contractor and the date of such service shall be the date of such delivery. The address named in the Proposal may be changed at any time by notice in writing from the Contractor to the HWMA. Nothing herein contained shall be deemed to preclude or render inoperative the service of any drawing, sample, notice, letter or other article or communication to or upon the Contractor personally.

6-02. Office of Contractor at Site. An office at the site is not required. Due to space limitations within the site, no space is available for a mobile office for the contractor use.

6-03. Attention to Work. The Contractor shall give his or her personal attention to and shall supervise the work to the end that it shall be prosecuted faithfully and when he or she is not personally present on the work, he or she shall at all reasonable times be represented by a competent superintendent or foreman who shall receive and obey all instructions or orders given under this contract and who shall have full authority to execute the same and to supply materials, tools and labor without delay and who shall be the legal representative of the Contractor. The Contractor shall be liable for the faithful observance of any instructions delivered to him or her or to his or her authorized representative.

6-04. Liability of Contractor. The Contractor shall do all of the work and furnish all labor, materials, tools and appliances, except as otherwise herein expressly stipulated, necessary or proper for performing and completing the work herein required in the manner and within the time herein specified. The mention of any specific duty or liability imposed upon the Contractor shall not be construed as a limitation or restriction of any general liability or duty imposed upon the Contractor by this contract, said reference to any specific duty or liability being made herein merely for the purpose of explanation.

The right of general supervision by the HWMA shall not make the Contractor an agent of the HWMA and the liability of the Contractor for all damages to persons or to public or private property, arising from the Contractor's execution of the work, shall not be lessened because of such general supervision.

Until the completion and final acceptance by the HWMA of all the work under and implied by the Contract, the work shall be under the Contractor's responsible care and charge. The Contractor shall rebuild, repair, restore and make good all injuries, damages, re-erections and repairs, occasioned or rendered necessary by causes of any nature whatsoever, acts of war, or terrorism to all or any portions of the work, except as otherwise stipulated.

To the fullest extent permitted by law, Contractor shall indemnify and hold harmless the HWMA and their officials, officers, agents, contractors (each, an "Indemnified Party;" collectively, the "Indemnified Parties") and employees from and against all claims, damages, losses and expenses including but not limited to attorneys' fees, costs of suit, expert witness fees and expenses and fees and costs of any necessary private investigators arising out of or resulting from the performance of the work, provided that any such claim, damage, loss or expense is caused in whole or in part by any act or omission of the Contractor, any subcontractor, or anyone directly or indirectly employed by any of them, or anyone for whose acts any of them may be liable, except where caused by the active negligence, sole negligence, or willful misconduct of the ("Indemnified Parties") .

In any and all claims against the HWMA or any of its agents or employees by any employee of the Contractor, any subcontractor, anyone directly or indirectly employed by any of them, or anyone for whose acts any of them may be liable, the indemnification obligation shall not be limited in any way by any limitation on the amount or type of damages, compensation or benefits payable by or for the Contractor or any subcontractor under workers' or workmen's compensation acts, disability benefit acts, or other employee benefit acts. The obligation to indemnify shall extend to and include acts of the Indemnified Party which may be negligent or omissions which may cause negligence.

The HWMA shall have the right to estimate the amount of such damage and to pay the same and the amount so paid for such damage shall be deducted from the money due the Contractor under this contract; or the whole or so much of the money due or to become due the Contractor under this contract as may be considered necessary by the HWMA, shall be retained by the HWMA until such suits or claims for damages shall have been settled or otherwise disposed of and satisfactory evidence to that effect furnished to the HWMA.

Contractor's responsibility for defense and indemnity obligations shall survive the termination or completion of this Contract for the full period of time allowed by law.

The defense and indemnification obligations of the Contract are undertaken in addition to, and shall not in any way be limited by, the insurance obligations contained in this Contract.

6-05. Protection of Persons and Property. The Contractor shall furnish such watchman, guards, fences, warning signs, walks and lights as shall be necessary and shall take all other necessary precautions to prevent damage or injury to persons or property.

All property line fences and improvements in the vicinity of the work shall be protected by the Contractor and, if they are injured or destroyed, they and any other property injured by the Contractor, his or her employees or agents, shall be restored to a condition as good as when he or she entered upon the work.

6-06. Protection of HWMA Against Patent Claims. All fees, royalties or claims for any patented invention, article or method that may be used upon or in any manner connected with the work under this contract shall be included in the price bid for the work and the Contractor and his or her sureties shall protect and hold the HWMA, together with all of their respective officials, officers, agents, employees, harmless against any and all demands made for such fees or claims brought or made on account of this contract. The Contractor shall, if requested by the Project Engineer, furnish acceptable proof of a proper release from all such fees or classes.

Should the Contractor, his or her agents, servants or employees, or any of them be enjoined from furnishing or using any invention, article, material or appliance supplied or required to be supplied or used under this Contract, the Contractor shall promptly substitute other articles, materials or appliance, in lieu thereof, of equal efficiency, quality, finish, suitability and market value and satisfactory in all respects to the Project Engineer. Or, in the event that the Project Engineer elects, in lieu of such substitution, to have supplied and to retain and use, any such invention, article, material or appliance, as may by this contract be required to be supplied, in that event the Contractor shall pay such royalties and secure such valid licenses as may be requisite and necessary for the HWMA, its officers, agents, servants and employees, or any of them, to use such invention, article, material or appliance without being disturbed or in any way interfered with by any proceeding in law or equity on account thereof. Should the Contractor neglect or refuse to make the substitution promptly, or to pay such royalties and secure such licenses as may be necessary, then in that event the Project Engineer shall have the right to make such substitution, or the HWMA may pay such royalties and secure such licenses and charge the cost thereof against any money due to the Contractor from the HWMA or recover the amount thereof from him or her and his or her sureties notwithstanding final payment under this contract may have been made.

6-07. Protection of Contractor's Work Property. The Contractor shall protect his or her work, supplies and materials from damage due to the nature of the work, the action of the elements, trespassers, or any cause whatsoever under his or her control, until the completion and acceptance of the work. Neither the HWMA nor any of their respective officials, officers, employees or agents assumes any responsibility for collecting indemnity from any person or persons causing damage to the work of the Contractor.

6-08. Regulations and Permits. The Contractor shall secure and pay for permits unless otherwise stated in the Technical Specifications, give all notices and comply with all laws, ordinances, rules and regulations bearing on the conduct of the work as drawn and specified. If the Contractor observes that the Plans and Special Provisions are at variance therewith, he or she shall promptly notify the Project Engineer in writing and any necessary changes shall be adjusted as provided in the contract for changes in the work.

6-09. Construction Utilities. The Contractor shall be responsible for providing for and in behalf of his or her work, all necessary utilities, such as special connection to water supply, telephones, power lines, fences, roads, watchmen, suitable storage places, etc.

6-10. Approval of Contractor's Plans. The approval by the Project Engineer of any drawing or any method of work proposed by the Contractor in accordance with paragraph 8-06 shall not relieve the Contractor of any of his or her responsibility for his or her errors therein and shall not be regarded as any assumption of risk or liability by the HWMA or any officer or employee thereof and the Contractor shall have no claim under this contract on account of the failure or partial failure or inefficiency of any plan or method so approved. Such approval shall be considered to mean merely that the Project Engineer has no objection to the Contractor's using, upon his or her own full responsibility the plan or method approved.

6-11. Suggestions to the Contractor. Any plan or method of work suggested by the Project Engineer to the Contractor, but not specified or required, if adopted or followed by the Contractor in whole or in part, shall be used at the risk and responsibility of the Contractor; and the Project Engineer and the HWMA shall assume no responsibility thereof.

6-12. Termination of Unsatisfactory Subcontracts. If any subcontractor(s) fail to perform in a satisfactory manner the work undertaken by him, such subcontract shall be terminated immediately by the Contractor upon notice from the Project Engineer.

6-13. Preservation of Stakes and Marks. The Contractor shall preserve carefully bench marks, reference points and stakes. In case of destruction, the Contractor shall replace stakes, reference points and bench-marks and shall be responsible for any mistakes that may be caused by their unnecessary loss or disturbance. Contractor's attention is directed to Section 7-03 of these General Provisions.

6-14. Assistance to Project Engineer. At the request of the Project Engineer the Contractor shall provide labor from its force and tools, stakes and other materials to assist the Project Engineer temporarily in making measurements and surveys and in establishing temporary or permanent reference marks. Payment for such materials and assistance will be made as provided for under the caption "Extra Work," provided, however, that the cost of setting stakes and marks carelessly lost or destroyed by the Contractor's labor will be assessed to the Contractor.

6-15. Removal of Condemned Materials and Structures. The Contractor shall remove from the site of the work, without delay, all rejected and condemned materials or structures of any kind brought to or incorporated in the work, and upon his or her failure to do so, or to make satisfactory progress in so doing, within forty-eight (48) hours after the service of a written notice from the Project Engineer, the condemned material or work may be removed by the HWMA and the cost of such removal shall be taken out of the money that may be due or may become due the Contractor on account of or by virtue of this contract. No such rejected or condemned material shall again be offered for use by the Contractor under this Contract.

6-16. Proof of Compliance with Contract Documents. In order that the Project Engineer may determine whether the Contractor has complied with the requirements of the Contract Documents, not readily enforceable through inspection and tests of the work and materials, the Contractor shall, at any time when requested, submit to the Project Engineer properly authenticated documents or other satisfactory proofs as to his or her compliance with such requirements.

6-17. Errors and Omissions. If the Contractor, in the course of the work, finds any errors or omissions in Plans or in the layout as given by survey points and instruction, or if he or she finds any discrepancy between the Plans and the physical conditions of the locality, he or she shall immediately inform the Project Engineer, in writing and the Project Engineer shall promptly verify the same. Any work done after such discovery, until authorized, will be done at the Contractor's risk.

6-18. Cooperation. The Contractor shall cooperate with all other contractors who may be performing work in behalf of the HWMA and workmen who may be employed by the HWMA on any work in the vicinity of the work to be done under this contract with the work of such contractors or workmen. Contractor shall make good promptly, at his or her

own expense, any injury or damage that may be sustained by other contractors or employees of the HWMA at his or her hands.

Any difference or conflict which may arise between the Contractor and other contractors, or between the contractor and workmen of the HWMA in regard to their work shall be adjusted and determined by the Project Engineer. If the work of the Contractor is delayed because of any acts or omissions of any other contractor or of the HWMA, the Contractor shall on that account have no claim against the HWMA other than for an extension of time.

6-19. Right of Contractor to Stop Work. Under the following conditions the Contractor shall have the right to stop the work and terminate the Contract upon ten (10) days written notice to the Project Engineer and recover from the HWMA payment for all work actually performed and for all satisfactory materials actually delivered to the site of the work for permanent incorporation therein, all as may be shown by the estimate of the Project Engineer.

(1) If the work be stopped under an order of any court or other competent public authority for a period of time of three (3) months through no act or fault of the Contractor or of anyone employed by him.

(2) If the Project Engineer fails to issue the monthly certificate for payment in accordance with the terms of the Contract Documents.

(3) If the HWMA fails to pay the Contractor within sixty (60) days after it shall have become due, as provided by the terms of the Contract Document, any sum certified by the Project Engineer or awarded by the HWMA.

All provided that if such action to terminate the contract be not instituted by the Contractor within ten (10) days after the alleged existence of such condition and if written notice of such action be not at that time delivered to the HWMA and the Project Engineer, then such right shall lapse until another occasion arises according to this section.

6-20. Hiring and Dismissal of Employees. The Contractor shall employ only such foremen, mechanics and laborers as are competent and skilled in their respective lines of work and whenever the Project Engineer shall notify the Contractor that any person on the work is, in his or her opinion, incompetent, unfaithful, intemperate or disorderly, or refuses to carry out the provisions of this contract, or uses threatening or abusive language to any person on the work representing the HWMA, or is otherwise unsatisfactory, such person shall be discharged immediately from the work and shall not be reemployed upon it except with the consent of the Project Engineer.

6-21. Wage Rates.

1. Contractor shall pay all mechanics and laborers employed or working upon the site of the work unconditionally and without subsequent deductions or rebate on any account the full amounts due at the time of payment at wage rates not less than those contained in the applicable prevailing wage determination, regardless of any contractual relationship which may be alleged to exist between the Contractor and subcontractors and such laborers and mechanics.

2. Contractor shall comply with the California Labor Code Section 1775. In accordance with said Section 1775, Contractor shall forfeit as a penalty to the HWMA, \$200.00 for each calendar day or portion thereof, for each worker paid less than the applicable prevailing wage rates for such work or craft in which such worker is employed for any work done under the Contract by him or her or by any subcontractor under him or her in violation of the provisions of the Labor Code and in particular, Labor Code Sections 1770 to 1780, inclusive. In addition to said penalty and pursuant to Section 1775, the difference between such applicable prevailing wage rates and the amount paid to each worker for each calendar day or portion thereof for which each worker was paid less than the applicable prevailing wage rate shall be paid to each worker by the Contractor.

3. Pursuant to the provision of Section 1770 of the Labor Code of the State of California, HWMA has ascertained the general prevailing rate of wages (which rate includes employer payments for health and welfare, vacation, pension and similar purposes) applicable to the work to be done, for straight time work. The holiday wage rate listed shall be applicable to all holidays recognized in the collective bargaining agreement of the particular craft, classification or type

of workmen concerned. The Contractor shall post the wage determination at the site of work in a prominent place where it can easily be seen by the workers.

4. HWMA will not recognize any claim for additional compensation because the Contractor has paid any rate in excess of the prevailing wage rate obtained by the Project Engineer. The possibility of wage increases is one of the elements to be considered by the Contractor in determining its bid and will not in any circumstances be considered as the basis for a claim against the HWMA.

5. Apprentices.

Attention is directed to the provisions in Sections 1777.5 and 1777.6 of the California Labor Code concerning the employment of apprentices by the Contractor or any subcontractor under him. Contractor and any subcontractor under him or her shall comply with the requirements of said sections in the employment of apprentices.

Information relative to apprenticeship standards, wage schedules and other requirements may be obtained from the Director of Industrial Relations, ex officio the Administrator of Apprenticeship, San Francisco, California, or from the Division of Apprenticeship Standards and its branch offices.

6. This project is subject to compliance monitoring and enforcement by the Department of Industrial Relations.

6-22. Cleaning Up. The Contractor shall not allow the site of the work to become littered with trash and waste material, but shall maintain the same in a neat and orderly condition throughout the construction period. The Project Engineer shall have the right to determine what is or is not waste material or rubbish and the place and manner of disposal.

On or before the completion of the work, the Contractor shall without charge therefore carefully clean out all pits, pipes, chambers, or conduits and shall tear down and remove all temporary structures built by him or her and shall remove rubbish of all kind from any of the grounds which he or she has occupied and leave them in first class condition.

6-23. Guaranty. All work shall be guaranteed for a period of one year from the date of acceptance by the HWMA. The Contractor shall promptly make all needed repairs arising out of defective materials, workmanship and equipment.

The HWMA is hereby authorized to make such repairs if within ten days after the mailing of a notice in writing to the Contractor or his or her agent, the Contractor shall neglect to make or undertake with due diligence the aforesaid repairs, provided, however, that in case of an emergency where, in the opinion of the HWMA delay would cause serious loss or damage, repairs may be made without notice being sent to the Contractor and the Contractor shall pay the costs thereof.

Pursuant to the provisions of Section 4-03 of the Special Provisions, the Contractor shall furnish a Defective Material and Workmanship Bond in an amount not less than 5 percent of the total Contract price, which shall be effective for a period of one (1) year after the completion and acceptance of the work.

SECTION 7. RESPONSIBILITIES AND RIGHTS OF HWMA

7-01. Authority of the Project Engineer. All work done under this Contract shall be done in a workmanlike manner and shall be performed to the reasonable satisfaction of the Project Engineer. To prevent disputes and litigation, the Project Engineer (1) shall in all cases determine the amount, quality, acceptability and fitness of the several kinds of work and materials which are to be paid for under this Contract, (2) shall decide all questions relative to the true construction, meaning and intent of the Special Provisions and Drawings, (3) shall decide all questions which may arise relative to the classifications and measurements of quantities and materials and the fulfillment of this Contract and (4) shall have the power to reject or condemn all work or material which does not conform to the Contract Documents. The Project Engineer's estimate and decision in all matters shall be a condition precedent to an appeal for arbitration, or the right of the Contractor to receive, demand, or claim any money or other compensation under this Contract and a condition precedent to any liability on the part of the HWMA to the Contractor on account of this contract. Whenever the Project Engineer shall be unable to act, in consequence of absence or other cause, then such Project Engineer as the HWMA shall designate, shall perform any and all of the duties and be vested with any or all of the powers herein given to the Project Engineer.

7-02. Observation. The HWMA will provide a Project Engineer for the inspection of the work.

The Project Engineer and his or her representatives shall at all times have access to the work whenever it is in preparation or progress and the Contractor shall provide proper facilities for such access and inspection.

If the Special Provisions, the Project Engineer's instruction, laws, ordinances, or any authority requires any work to be specially tested or approved, the Contractor shall give the Project Engineer timely notice of its readiness for inspection and, if the inspection is by an authority other than the Project Engineer, of the date fixed for such inspection. Inspections by the Project Engineer shall be promptly made at the source of supply where practicable. If any work shall be covered up without approval or consent of the Project Engineer, it must, if required by the Project Engineer, be uncovered for examination and properly restored at the Contractor's expense.

Re-examination of any work may be ordered by the Project Engineer and, if so ordered, the work must be uncovered by the Contractor. If such work is found to be in accordance with the Contract Documents, the HWMA shall pay the cost of re-examination and replacement. If such work is not in accordance with the Contract Documents, the Contractor shall pay such cost.

Properly authorized and accredited inspectors shall be considered to be the representatives of the HWMA limited to the duties and powers entrusted to them. It will be their duty to inspect materials and workmanship of those portions of the work to which they are assigned, either individually or collectively, under instructions of the Project Engineer and to report any and all deviations from the Drawings, Special Provisions and other contract provisions which may come to their notice. Any inspector may be considered to have the right to order the work entrusted to his or her supervision stopped, if in his or her opinion such action becomes necessary, until the Project Engineer is notified and has determined and ordered that the work may proceed in due fulfillment of all contract requirements.

7-03. Surveys. Contractor shall furnish all land surveys, establish all base lines and bench marks and make sufficient detailed surveys needed for working points, lines and elevations. The Contractor shall develop all slope stakes and batter boards. Contractor shall also develop all additional working points, lines and elevations as he or she may desire to facilitate his or her methods and sequence of construction.

7-04. Rights-of-Way. The HWMA will provide all rights-of-way and easements in or beneath which pipes and other structures will be constructed by the Contractor under the Contract Documents.

7-05. Retention of Imperfect Work. If any portion of the work done or material furnished under this Contract shall prove defective and not in accordance with the Plans and Special Provisions, and if the imperfection in the same shall not be of sufficient magnitude or importance to make the work dangerous or undesirable, the Project Engineer shall have the right and authority to retain such work instead of requiring the imperfect work to be removed and reconstructed, but

he or she shall make such deductions therefor in the payments due or to become due the Contractor as may be just and reasonable.

7-06. Changes in the Work. The Owner shall have the right, in writing, to order additions to, omissions from, or corrections, alterations and modifications in the line, grade, form, dimensions, plan, or kind or amount of work or materials herein contemplated, or any part thereof, either before or after the beginning of construction. Such alterations shall in no way affect, vitiate, or make void this contract or any part thereof, except that which is necessarily affected by such alterations and is clearly the evident intention of the parties to this contract.

Unless otherwise specifically directed in writing by the Owner or Project Engineer, prior to performing additional work, the Contractor shall submit a written request for change order to the Project Engineer and Owner for review. No extra work shall be performed or change made except pursuant to a written order from the Owner or Project Engineer stating the extra work or change is authorized, and setting forth the basis upon which payment is to be made. No claim for additional compensation shall be valid unless pursuant to such a change order. Nothing in this section shall excuse the Contractor from proceeding with the prosecution of the changed work. When required by the Owner or Project Engineer, the Contractor shall furnish an itemized breakdown of the quantities and prices used in computing the value of any ordered change.

7-07. Additional Drawings by HWMA. The Drawings made a part of the Contract Documents are intended to be fairly comprehensive and to indicate in more or less detail the scope of the work. In addition to these Drawings, however, the Project Engineer may furnish additional clarification from time to time during the progress of the work as are necessary to make clear or to define in greater detail the intent of the Special Provisions and the Contract Drawings and the Contractor shall make his or her work conform to all such Drawings.

7-08. Additional and Emergency Protection. Whenever the Contractor has not taken sufficient precautions for the safety of the public or the protection of the works to be constructed under this Contract, or of adjacent structures or property which may be injured by the processes of construction on account of such neglect and whenever, an emergency shall arise and immediate action shall be considered necessary in order to protect public or private, personal or property interest, then and in that event, the HWMA, with or without notice to the Contractor may provide suitable protection to the said interests by causing such work to be done and such material to be furnished as shall provide such protection.

The cost and expense of such work and material so furnished shall be borne by the Contractor and, if the same shall not be paid on presentation of the bills therefor, then such costs shall be deducted from any amounts due or to become due the Contractor.

7-09. Suspension of Work. The HWMA may at any time suspend the work or any part thereof by giving five (5) days written notice to the Contractor. The work shall be resumed by the Contractor within ten (10) days after the date fixed in the written notice from the HWMA to the Contractor so to do. The HWMA shall reimburse the Contractor for expense incurred by the Contractor in connection with the work under this Contract as a result of such suspension.

If the work, or any part thereof, shall be stopped by the notice in writing aforesaid and if the HWMA does not give notice in writing to the Contractor to resume work at a date within ten (10) days of the date fixed in the written notice to suspend, then the Contractor may abandon that portion of the work so suspended and he or she will be entitled to the estimates and payments for all work done on the portions so abandoned, if any, plus 5 percent of the value of the work so abandoned, to compensate for loss of overhead, plant expense and anticipated profit.

7-10. Right of HWMA to Terminate Contract. If the Contractor is adjudged bankrupt, or if the Contractor makes a general assignment for the benefit of the Contractor's creditors, or if a receiver is appointed on account of the Contractor's insolvency, or if the Contractor persistently or repeatedly refuses or fails, except in cases for which extension of time is provided, to supply sufficient properly skilled workmen or proper materials, or if the Contractor fails to make prompt payments to subcontractors or for material or labor, or persistently disregard laws, ordinances or the instructions of the Project Engineer, or otherwise be guilty of a substantial violation of any provision of the contract, then the HWMA, upon the certificate of the Project Engineer that sufficient cause exists to justify such action, may, without prejudice to any other right or remedy and after giving the Contractor seven days written notice, terminate the work of the Contractor and

take possession of the premises and of all materials, tools and appliances and finish the work by whatever method the HWMA may deem expedient. In such case, the Contractor shall not be entitled to receive any further payment until the work is finished. If the unpaid balance of the contract price shall exceed the expense of finishing the work, including compensation for additional managerial and administrative services, *the remainder of the Contractor's unpaid balance will be paid*. If such expense shall exceed such unpaid balance, the Contractor shall pay the difference to the HWMA. The expense incurred by the HWMA as herein provided and the damage incurred through the Contractor's default, shall be certified by the Project Engineer.

7-11. Use of Completed Portions. The HWMA shall have the right to take possession of and use any completed or partially completed portions of the work, notwithstanding the time for completing the entire work or such portions which may not have expired; but such taking possession and using shall not be deemed an acceptance of any work not completed in accordance with the contract documents. If such prior use increases the cost of or delays the work, the Contractor shall be entitled to such extra compensation, or extension of time or both, as the Project Engineer may determine.

SECTION 8. WORKMANSHIP, MATERIALS and EQUIPMENT

8-01. General Quality. Materials and equipment shall be new and of a quality equal to that specified or approved. Work shall be done and completed in a thorough and workmanlike manner.

8-02. Quality in Absence of Detailed Specifications. Whenever the Contractor is required to furnish materials or manufactured articles or do work for which no detailed specifications are set forth, the materials or manufactured articles shall be of the best grade in quality and workmanship obtainable in the market from firms of established good reputation, or, if not ordinarily carried in stock, shall conform to the usual standards for first-class materials or articles of the kind required, with due consideration of the use to which they are to be put. In general, the work performed shall be in full conformity and harmony with the intent to secure the best standard of construction and equipment of the work as a whole or in part.

8-03. Materials and Equipment Specified by Name. Whenever any material or equipment is indicated or specified by patent or proprietary name or by the name of the manufacturer, such specification shall be considered as used for the purpose of describing the material or equipment desired and shall be considered as followed by the words "or approved equal". The Contractor may offer any material or equipment which shall be equal, or better, in every respect to that specified, provided that written approval first is obtained from the Project Engineer.

8-04. Source of Materials. Price, fitness and quality being equal, preference shall be given by the Contractor for supplies grown, manufactured or produced in the State of California and, next, for such products partially produced in this State in accordance with Government Code Section 4332.

8-05. Storage of Materials. Materials shall be so stored to ensure the preservation of their quality and fitness for the work. They shall be so located and disposed that prompt and proper inspection thereof may be made.

8-06. Drawings, Samples and Tests. The Contractor shall submit to the Project Engineer submittals when requested in the Technical Specifications. The Contractor shall have no claims for damages or for extension of time on account of any delay due to the revision of drawings or rejection of material. Fabrication or other work performed in advance of approval shall be done entirely at the Contractor's risk. After approval of equipment or material, the Contractor shall not deviate in any way from the design and specifications given without the written consent of the Project Engineer.

When requested by the Project Engineer, a sample or test specimens of the materials to be used or offered for use in connection with the work shall be prepared at the expense of the Contractor and furnished by him or her in such quantities and sizes as may be required for proper examination and tests, with all freight charges prepaid and with information as to their sources.

All samples shall be submitted before shipment and in ample time to permit the making of proper tests, analyses, or examination before the time at which it is desired to incorporate the material into the work. All tests of materials furnished by the Contractor shall be made by a certified testing laboratory. Samples shall be secured and tested whenever necessary to determine the quality of the material.

SECTION 9. PROSECUTION OF WORK

9-01. Equipment and Methods. The work under this Contract shall be prosecuted with all materials, tools, machinery, apparatus and labor and by such methods as are necessary to the complete execution of everything described, shown, or reasonably implied. If at any time before the beginning or during the progress of the work, any part of the Contractor's plant or equipment, or any of his or her methods of execution of the work, appear to the HWMA to be unsafe, inefficient, or inadequate to insure the required quality or the rate of progress of the work, he or she may order the Contractor to increase or improve his or her facilities or methods and the Contractor shall comply promptly with such orders; but, neither compliance with such orders nor failure of the Project Engineer to issue such orders shall relieve the Contractor from his or her obligation to secure the degree of safety, the quality of the work and the rate of progress required of the Contractor. The Contractor alone shall be responsible for the safety, adequacy and efficiency of his or her plant, equipment and methods.

9-02. Time of Completion. The Contractor shall promptly begin the work and shall complete and make ready for full use all work within the time set forth in the Contract. Due to the frequent use of the facility, the construction shall occur in a manner as to not disrupt or impede operation of the facility. The construction window and start time shall be coordinated with the Owner at least 3 weeks in advance. If additional time is anticipated, this should be indicated in the Bid Proposal and coordinated between HWMA and the selected bidder.

9-03. Avoidable Delays. Avoidable delays in the prosecution or completion of the work shall include all delays which might have been avoided by the exercise of care, prudence, foresight and diligence on the part of the Contractor. The HWMA will consider as avoidable delays within the meaning of this Contract (1) delays in the prosecution of parts of the work, which may in themselves be unavoidable, but do not necessarily prevent or delay the prosecution of other parts of the work nor the completion of the whole work within the time herein specified, (2) reasonable loss of time resulting from the necessity of submitting plans to the Project Engineer for approval and from the making of surveys, measurements, inspections, and testing and (3) such interruptions as may occur in the prosecution of the work on account of the reasonable interference of other contractors employed by the HWMA which do not necessarily prevent the completion of the whole work within the time herein specified.

9-04. Unavoidable Delays. Unavoidable Delays in the prosecution or completion of the work under this Contract shall include all delays which may result, through cause beyond the control of the Contractor and which he or she could not have provided against by the exercise of care, prudence, foresight and diligence. Orders issued by the HWMA changing the amount of work to be done, the quantity of material to be furnished or the manner in which the work is to be prosecuted and unforeseen delays in the completion of the work of other contractors under contract with the HWMA will be considered unavoidable delays, in so far as they necessarily interfere with the Contractor's completion of the whole of the work. Delays due to normally adverse weather conditions will not be regarded as unavoidable delays. However, truly abnormal amounts of rainfall, temperatures or other weather conditions for the location of the work and time of year may be considered as unavoidable delays if those conditions necessarily cause a delay in the completion of the work. "Abnormal" is defined as any event that exceeds a 10-year recurrence interval.

9-05. Notice of Delays. Whenever the Contractor foresees any delay in the prosecution of the work and, in any event, immediately upon the occurrence of any delay which the contractor regards as an unavoidable delay, he or she shall notify the Project Engineer in writing of the probability of the occurrence of such delay and its cause, in order that the Project Engineer may take immediate steps to prevent, if possible, the occurrence or continuance of the delay, or, if this cannot be done, may determine whether the delay is to be considered avoidable or unavoidable, how long it continues and to what extent the prosecution and completion of the work are to be delayed thereby.

9-06. Extension of Time. If any delays occur which the Project Engineer may consider unavoidable, as herein defined, the Contractor shall, pursuant to his or her application, be allowed an extension of time proportional to said delay or delays, beyond the time herein set forth, in which to complete this Contract; and liquidated damages for delay shall not be charged against the Contractor by the HWMA during an extension of time granted because of unavoidable delay or delays.

Any claim by Contractor for a time extension based on unavoidable delays shall be based on written notice delivered to the Project Engineer within 3 business days of the occurrence of the event giving rise to the claim. Failure to file said written notice within the time specified shall constitute a waiver of said claim. Notice of the full extent of the claim and all supporting data must be delivered to the Project Engineer within 45 days of the occurrence unless the Project Engineer

specifies in writing a longer period. All claims for a time extension must be approved by the Project Engineer and incorporated into a written change order.

9-07. Unfavorable Weather and Other Conditions. During unfavorable weather and other conditions, the Contractor shall pursue only such portions of the work as shall not be damaged thereby. No portions of the work whose satisfactory quality or efficiency will be affected by any unfavorable conditions shall be constructed while these conditions remain, unless, by special means or precautions approved by the Project Engineer, the Contractor shall be able to overcome them.

The Contractor shall be granted a time extension of one day for each unfavorable weather day which prevents him or her from placing concrete forms or placing and finishing concrete or asphalt concrete. Such unfavorable weather day is defined as a rain day where precipitation prevents the contractor from performing the work more than four (4) continuous hours within the authorized work period or a temperature day where the ambient temperature is below that specified for the placement of materials associated with the controlling work item for more than four (4) continuous work hours of the authorized work period.

9-08. Expected Hours: The HWMA facility operates seven days a week except for state or federal holidays. Normal hours are Monday through Saturday from 8:00 A.M. to 4:00 P.M., and Sunday from 10:00 A.M. to 4:00 P.M. Provision can be made for after-hours access if needed.

9-09. Hours of Labor. Eight (8) hours of labor shall constitute a legal day's work and the Contractor or any subcontractor shall not require or permit more than eight hours of labor in a day from any person employed by him or her in the performance of the work under this Contract, unless paying compensation for all hours worked in excess of eight (8) hours per day at not less than 1 ½ times the basic rate of pay.

SECTION 10. PAYMENT

10-01. Certification by Project Engineer. All payments under this Contract shall be made upon the presentation of certificates in writing from the Project Engineer and shall show that the work covered by the payments has been done and the payments thereof are due in accordance with this contract.

10-02. Progress Estimates and Payment. The Project Engineer shall, within the first seven (7) days of each month, make an estimate of the value of the work performed in accordance with this Contract during the previous calendar month.

The first estimate shall be of the value of the work satisfactorily completed in place and meeting the requirements of the contract. And every subsequent estimate, except the final estimate, shall be of the value of the work satisfactorily completed in place since the last preceding estimate was made; provided, however, that should the Contractor fail to adhere to the program of completion fixed in this Contract, the Owner shall deduct from the next and all subsequent estimates the full calculated accruing amount of the liquidated damages to the date of said estimate, until such time as the compliance with the program has been restored.

The estimate shall be signed by the Owner's representative and, after approval, the HWMA shall pay or cause to be paid to the Contractor in the manner provided by law, an amount equal to 95 percent of the estimated value of the work satisfactorily performed and complete in place.

10-03. Substitution of Securities.

1. At such times that Government Code Section 4590 is in effect Contractor may propose the substitution of securities of at least equal market value for any moneys to be withheld to ensure performance under the Contract. Market value shall be determined as of the day prior to the date such substitution is to take place. Such substitution shall be made at the request and expense of the Contractor. The securities shall be one or more of the following types:

(a) Bonds or interest-bearing notes or obligations of the United States, or those for which the faith and credit of the United States are pledged for the payment of principal and interest.

(b) Bonds or interest-bearing notes on obligations that are guaranteed as to principal and interest by a federal HWMA of the United States.

(c) Bonds of the State of California, or those for which the faith and credit of the State of California are pledged for the payment of principal and interest.

(d) Bonds, consolidated bonds, collateral trust debentures, consolidated debentures, or other obligations issued by federal land banks or federal intermediate credit banks established under the Federal Farm Loan Act, as amended; debentures and consolidated debentures issued by the Central Bank for Cooperatives and banks for cooperatives established under the Farm Credit Act of 1933, as amended; bonds, or debentures of the Federal Home Loan Bank Board established under the Federal Home Loan Bank Act; and stock, bonds, debentures and other obligations of the Federal National Mortgage Association established under the National Housing Act as amended and bonds of any Federal Home Loan Mortgage Corporation.

(e) Commercial paper of "prime" quality as defined by a nationally recognized organization which rates such securities. Eligible paper is further limited to issuing corporations: (1) organized and operating within the United States; (2) having total assets in excess of five hundred million dollars (\$500,000,000); and (3) approved by the Pooled Money Investment Board of the State of California. Purchases of eligible commercial paper may not exceed 180 days' maturity, nor represent more than 10 percent of the outstanding paper of an issuing corporation.

(f) Bills of exchange or time drafts on and accepted by a commercial bank, otherwise known as banker's acceptances, which are eligible for purchase by the Federal Reserve System.

(g) Certificates of deposits issued by a nationally or state-chartered bank or savings and loan association.

(h) The portion of bank loans and obligations guaranteed by the United States Small Business Administration or the United States Farmers Home Administration.

(i) Student loan notes insured under the Guaranteed Student Loan Program established pursuant to the Higher Education Act of 1965, as amended (20 U.S.C. 1001, et seq.) and eligible for resale to the Student Loan Marketing Association established pursuant to Section 133 of the Education Amendments of 1972, as amended (20 U.S.C. 1087-2).

(j) Obligations issued, assumed or guaranteed by International Bank for Reconstruction and Development, the Inter-American Development Bank, the Asian Development Bank, or the Government Development Bank of Puerto Rico.

(k) Bonds, debentures and notes issued by corporations organized and operating within the United States. Such securities eligible for substitution shall be within the top three ratings of a nationally recognized rating service.

2. The securities shall be deposited with HWMA or with any commercial bank as escrow agent, who shall arrange for transfer of such securities to the Contractor upon satisfactory completion of the contract. Any interest accrued or paid on such securities shall belong to the Contractor and shall be paid upon satisfactory completion of the contract.

The market value of the securities deposited shall at all times be maintained in an amount at least equal, in the sole judgment of HWMA, to the moneys to be withheld pursuant to the Contract Documents to ensure performance of the Contract. In order to comply with this condition, Contractor shall deposit additional securities as necessary upon request by HWMA or the escrow agent.

3. Upon acceptance of any Proposal that includes substituting securities for amounts withheld to ensure performance, a separate escrow agreement satisfactory in form and substance to HWMA shall be prepared and executed by HWMA, the Contractor and the escrow agent, which may be HWMA. The escrow agreement shall specify, among other matters, value of securities to be deposited; procedures for valuing the securities and for adding or withdrawing securities to maintain the market value of the deposited securities at least equal to the amount of moneys which would otherwise be withheld; the terms and conditions of conversion to cash in case of the default by the Contractor; and terms, conditions and procedure for termination of the escrow.

HWMA shall have no obligation to enter any such Agreement that does not provide the HWMA with the unilateral right to convert securities to cash and to gain immediate possession of the cash.

10-04. Acceptance. The work must be accepted by the HWMA when the whole shall have been completed satisfactorily. The Contractor shall notify the Project Engineer, in writing, of the completion of the work, whereupon the Project Engineer shall promptly, by personal inspection, satisfy himself as to the actual completion of the work in accordance with the terms of the contract and shall thereupon recommend acceptance by the HWMA.

10-05. Final Estimate and Payment. The Project Engineer shall, as soon as practicable after the final acceptance of the work done under this Contract, make a final estimate of the amount of work done thereunder and the value thereof.

Such final estimate shall be signed by the Project Engineer, and after approval, the HWMA shall pay or cause to be paid to the Contractor, in the manner provided by law, the entire sum so found to be due hereunder, after deducting therefrom all previous payments and such other lawful amounts as the terms of this Contract prescribe.

In no case will final payment be made in less than thirty-five (35) days after the filing of the notice of completion with the HWMA Recorder.

10-06. Delay Payments. If any payment due the Contractor or any estimate is delayed, through fault of the HWMA beyond the time stipulated, such delay shall not constitute a breach of contract or be the basis for a claim for damages, but the HWMA shall pay the Contractor interest on the amount of the payment at the rate of 6 percent per annum for the period of such delay. The terms for which interest will be paid shall be reckoned, in the case of any monthly or progress payment, from the twentieth day of the month next succeeding the month in which the work was performed to the date of payment of the estimate; and in the case of the final estimate, from the forty-fifth day after acceptance to the date of payment of the final estimate.

The date of payment of any estimate shall be considered the day on which the payment is offered or mailed as evidenced by the records of the Treasurer of the HWMA. If interest shall become due on any delayed payment, the amount thereof, as determined by the HWMA, shall be added to a succeeding payment. If the interest shall become due on the final payment, it shall be paid on a supplementary voucher to interest or any sum or sums which, by the terms of this Contract, the HWMA is authorized to reserve or retain.

10-07. Extra Work and Work Omitted. Whenever corrections, alterations, or modifications of the work under this Contract ordered by the Project Engineer and approved by the HWMA increase the amount of work to be done, such added work shall be known as "extra work"; and when such corrections, alterations, or modifications decrease the amount of work to be done, such subtracted work shall be known as "work omitted".

When the Contractor considers that any changes ordered involve extra work, he or she shall immediately notify the Project Engineer in writing and subsequently keep him or her informed as to when and where extra work is to be performed, provide a cost estimate for performing the work for approval by the HWMA before performing the work, and, if the estimate is approved, shall make claim for compensation therefor each month not later than the first day of the month following that in which the work claimed to be extra work was performed and he or she shall submit a daily complete statement of materials and labor used and expenses incurred on account of extra work performed, showing allocation of all materials, labor and expenses.

All such claims shall state the date of the Project Engineer's written order and the date of approval by the HWMA authorizing the work on account of which claim is made. Unless such notification is made in writing within the time specified and unless complete statements of materials used and expenses incurred on account of such extra work are furnished as above required, the Contractor shall not be entitled to payment on account of extra work and Contractor shall be deemed to have waived the right to make any future claims for compensation for such extra work.

When changes decrease the amount of work to be done, they shall not constitute a claim for damages on account of anticipated profits on the work that may be omitted.

10-08. Compensation for Extra Work or Work Omitted. Whenever corrections, additions, or modifications in the work under this Contract change the amount of work to be done or the amount of compensation due the Contractor, excepting increases or decreases in contract items having unit contract prices for each measurable quantity installed in place, and such changes have been ordered in writing by the Project Engineer and approved by the HWMA prior to the Contractor performing the extra work, then a price may be agreed upon. Failing such an agreement in price, either the extra work will not be performed or the Contractor shall be compensated for performing extra work pursuant to the provisions of Section 4-1.03 D, "Extra Work", and Section 9-1.03, "Force Account Payment" of the California Standard Specifications.

This method of determining the price of work shall not apply to the performance of any work which is required or reasonably implied to be performed or furnished under this Contract.

10-09. Compensation to the HWMA for Extension of Time. In case the work called for under this Contract is not completed within the time limit stipulated herein, the HWMA shall have the right as provided hereinabove, to extend the time of completion thereof. If the time limit be so extended, the HWMA shall have the right to charge to the Contractor and to deduct from the final payment for the work the actual cost to the HWMA of engineering, inspection, superintendence and other overhead expenses which are directly chargeable to the contract and which accrue during the period of such extension, except that the cost of final unavoidable delays shall not be included in such charges.

10-10. Liquidated Damages for Delay. It is agreed by the parties to the Contract that time is of the essence and that, in case all the work is not completed before or upon the expiration of the time limit as set forth, damage, other than those cost items identified in Section 10-09, will be sustained by the HWMA and that it is and will be impracticable to determine the actual amount of damage by reason of such delay; and it is therefore agreed that the Contractor will pay to the HWMA the amount per calendar day shown in Article 1 of the Contract.

SECTION 11. MISCELLANEOUS

11-01. Notice. Whenever any provision of the contract documents requires the giving of written notice, it shall be deemed to have been validly given if delivered in person to the individual or to a member of the firm or to an officer of the corporation for whom it is intended, or if delivered at or sent by registered or certified mail, postage prepaid, to the last business address known to the giver of the notice. If mailed, the notice shall be deemed received on the date of delivery stated in the return receipt.

11-02. Computation of Time. When any period of time is referred to in the Contract Documents by days, it shall be computed to exclude the first and include the last day of such period. If the last day of any such period falls on a Saturday or Sunday or on a day made a legal holiday by the law of the applicable jurisdiction, such day shall be omitted from the computation.

11-03. Litigation and Forum Selection. Contractor and HWMA stipulate and agree that any litigation relating to the enforcement or interpretation of this contract, arising out of Contractor's performance or relating in any way to the work shall be brought in Humboldt County Superior Court and that venue will lie in Humboldt County.

The parties waive any objections they might otherwise have to the propriety of jurisdiction or venue in the state courts in Humboldt County and agree that California law shall govern any such litigation.

The duties and obligations imposed by these General Conditions and the rights and remedies available hereunder to the parties hereto and, in particular but without limitation, the warranties, guaranties and obligations imposed upon the Contractor and all of the rights and remedies available to the HWMA thereunder, shall be in addition to and shall not be construed in any way as a limitation of, any rights and remedies available to any or all of them which are otherwise imposed or available by law or contract, by special warranty or guaranty, or by other provisions of the contract documents and the provisions of this paragraph shall be as effective as if repeated specifically in the contract documents in connection with each particular duty, obligation, right and remedy to which they apply. All warranties and guaranties made in the contract document shall survive final payment and termination or completion of this contract.

11-04. Waiver. The Contractor shall strictly comply with all notices and other contract requirements. Waiver by the HWMA of any failure of the Contractor to comply with any term of the contract, including the notice provisions, shall not be deemed a waiver of a subsequent breach.

11-05. Bid Protest. Any bid protest must be in writing and must be received by the Executive Director of Humboldt Waste Management Authority, 1059 W. Hawthorne Street, Eureka, CA 95501 or by email before 4:00 p.m. no later than three (3) working days following bid opening (the "Bid Protest Deadline") and must comply with the following requirements:

- A. Only a bidder who has actually submitted a Bid Proposal is eligible to submit a bid protest against another bidder. Subcontractors are not eligible to submit bid protests. A bidder may not rely on the bid protest submitted by another bidder, but must timely pursue its own protest.
- B. The bid protest must contain a complete statement of the basis for the protest and all supporting documentation. Material submitted after the Bid Protest Deadline will not be considered. The protest must refer to the specific portion or portions of the Contract Documents upon which the protest is based. The protest must include the name, address and telephone number of the person representing the protesting bidder if different from the protesting bidder.
- C. A copy of the protest and all supporting documents must also be transmitted by fax or by email, by or before the Bid Protest Deadline, to the protested bidder and any other bidder who has a reasonable prospect of receiving an award depending upon the outcome of the protest.
- D. The protested bidder may submit a written response to the protest, provided the response is received by the Executive Director before 5:00 p.m., within two (2) working days after the Bid Protest Deadline or after receipt of the bid protest, whichever is sooner (the "Response Deadline"). The response must include all supporting documentation. Material submitted after the Response Deadline will not be

considered. The response must include the name, address and telephone number of the person representing the protested bidder if different from the protested bidder.

- E. The procedure and time limits set forth in this section are mandatory and are the bidder's sole and exclusive remedy in the event of bid protest. The bidder's failure to comply with these procedures shall constitute a waiver of any right to further pursue a bid protest, including filing a Government Code Claim or initiation of legal proceedings.

SPECIAL PROVISIONS AND TECHNICAL SPECIFICATIONS

SECTION 12. GENERAL INFORMATION

12-01. Arrangement of Technical Specifications. The Technical Specifications are arranged in sections using the CSI Format covering the various phases of work as follows:

Section No.	Title
12	General Information
13	Exclusions from General Conditions
14	Amendments to General Conditions
15	Construction Details

12-02. Arrangement of Project Specific Plans. The Project Specific Plans ("Project Plans") consist of six sheets and are hereby made a part of the Contract Documents.

12-03. Permits. The Contractor shall provide, procure and pay for all permits including encroachment permits required to carry on and complete this work.

12-04. Standard Specifications and Standard Plans. The Standard Specifications and Standard Plans of the California State Department of Transportation, July 2010, (herein "California Standard Specifications" and "California Standard Plans," respectively), which are hereby made a part of these Special Provisions except as expressly modified. Further, the California Standard Specifications are superseded by these documents and specification where in conflict or otherwise contradictory.

Whenever in the California Standard Specifications and the California Standard Plans the following terms are used, they shall be understood to mean and refer to the following:

Department of Transportation – Humboldt Waste Management Authority.

Director of Public Works – Humboldt Waste Management Authority Executive Director.

Project Engineer - The Engineer, designated by the HWMA, acting either directly or through properly authorized agents, such agents acting within the scope of the particular duties entrusted to them.

Laboratory - The designated laboratory authorized by the HWMA to test materials and work involved in the contract.

State - The Humboldt Waste Management Authority.

Other terms appearing in the California Standard Specifications and the California Standard Plans shall have the intent and meaning specified in Section I, Definition of Terms of the California Standard Specifications.

In case of discrepancy between the contract documents, the order of precedence from the highest to lowest is as follows:

1. (HWMA) Special Provisions
2. (HWMA) Project Plans
3. (HWMA) Standard Plans and Details
5. California Standard Plans
6. California Standard Specifications

Notwithstanding the above, any discrepancies shall be coordinated with the Project Engineer for clarification. This is the Contractor's responsibility.

12-05. Temporary Facilities. All temporary facilities are the responsibility of the Contractor. The removal of said facilities shall be the responsibility of the Contractor. The Contractor shall be responsible for any and all damages to existing facilities which are a result of the work.

12-06. Existing Utilities. It is the responsibility of the Contractor to contact Underground Services Alert and mark the locations of existing utilities. The accuracy of completeness of existing underground utilities (both public and privately owned) on the Drawings is not guaranteed, however, unless otherwise indicated on the Project Plans or in these Special Provisions, all water, gas or sewer lines, lighting, power or telephone conduits, structures, house connections lines and other surface or subsurface structures of any nature that may be affected by the work shall be maintained by the Contractor and shall not be disturbed, disconnected or damaged by him or her during the progress of the work; provided, that if the Contractor in the performance of the work disturbs, disconnects or damages any of the above, all expenses of whatever nature arising from such disturbance or the replacement or repair thereof shall be borne by the Contractor.

In case it is necessary to move permanently or to maintain temporarily the property of any public utility or other property, the cost must be borne by the Contractor. All existing utilities shall be kept in service during the progress of the work. Where protection is required to insure support located substantially as shown on the Project Plans, the Contractor shall furnish and place the necessary protection at his or her expense.

12-07. Public Convenience and Safety. The Contractor shall conduct operations so as to cause the least possible obstruction and inconvenience to HWMA customer traffic. The Contractor shall, at his or her expense, furnish such flag persons and furnish, erect, construct and maintain such fences, barriers, lights, signs, detours, pedestrian walkways, driveway ramps and bridging as may be necessary to give adequate warning to HWMA customers that work is in progress and that dangerous conditions exist, and to provide access to abutting properties and to permit the flow of pedestrian and vehicular traffic to safely and expeditiously pass the work. The Contractor shall coordinate operations with the HWMA Operations Manager and/or the HWMA Operations Supervisor, so as to minimize disruption of routine on-site activities by HWMA personnel and the general public.

12-08. Cooperation. Attention is directed to Section 7-1.14 of the California Standard Specifications.

Other construction work by other forces relocating power lines, telephone lines and pipe lines, and constructing other improvements, may be in progress within and adjacent to the limits of the work at the time the work is being performed.

The Contractor for the work herein specified shall cooperate with the force engaged in performing other work as above described to the end that such forces may conduct their operations with as little inconvenience and delay as possible, and the Contractor shall permit such forces passage through the work as is reasonable and necessary to transport their materials and equipment to the site of their operations.

Full compensation for conforming to the requirements of this Section shall be considered as included in the prices paid for the various contract items of work and no additional allowance will be made therefore.

12-09. Dust Control. Dust control shall conform to the provisions in Section 10 of the California Standard Specifications and these Special Provisions (if noted).

Full compensation for dust control shall be considered as included in the prices paid for the various contract items of work, and no additional compensation will be allowed therefor.

12-10. Stream Pollution. The Contractor shall exercise every reasonable precaution to prevent muddying or silting of live streams, and the Contractor's attention is called to the fact that the terms of this contract do not relieve him or her of responsibility for compliance with Sections 5650 and 12015 of the Fish and Game Code or other applicable statutes relating to pollution prevention or abatement.

12-11. Notification of Underground Service Alert (USA). The Contractor shall notify Underground Service Alert (USA) two (2) working days prior to any excavation. Dial (toll free) 1 (800) 227-2600.

12-12. Modifications of Standard Specifications.

- A. Variance of final quantities from bid quantities: Because of the nature of the work, final quantities may vary significantly from the estimated quantities on the proposal form. It is assumed that because of the nature of

the work, overhead will be distributed proportionally across the unit prices quoted by the Contractor. Therefore, Section 9-1.06c of the California Standard Specifications that allows calculation of change in overhead final quantity by more than 25% from the estimated bid quantities is deleted from the Standard Specifications. It is assumed that all overhead is contained within the unit prices and the overhead will change in proportion to the amount of work provided.

SECTION 13. EXCLUSIONS FROM GENERAL CONDITIONS

13-01. Provisions to be Excluded from General Conditions. The following designated provisions of the General Conditions are hereby determined to be inapplicable to the proposed work and, therefore, are hereby excluded from the terms of the Contract Documents as though entirely omitted from said General Conditions:

No exclusions.

SECTION 14. AMENDMENTS TO GENERAL CONDITIONS

14-01. Sections of General Conditions to be Amended.

The following designated sections of the General Conditions are hereby amended to read as follows:

SECTION 15. CONSTRUCTION DETAILS

15-01. Technical Specifications and Product Information.

No technical specifications are attached to this Bid document. However, the Drawings indicated specific products that must be installed according per the manufacture instructions and/or recommendations.

15-02. Drawings

The Drawings or Figures for the project shall be considered part of these Contract Documents.

EUREKA TRANSFER STATION – FLOOR OVERLAY

1059 WEST HAWTHORNE STREET

MARCH 2023

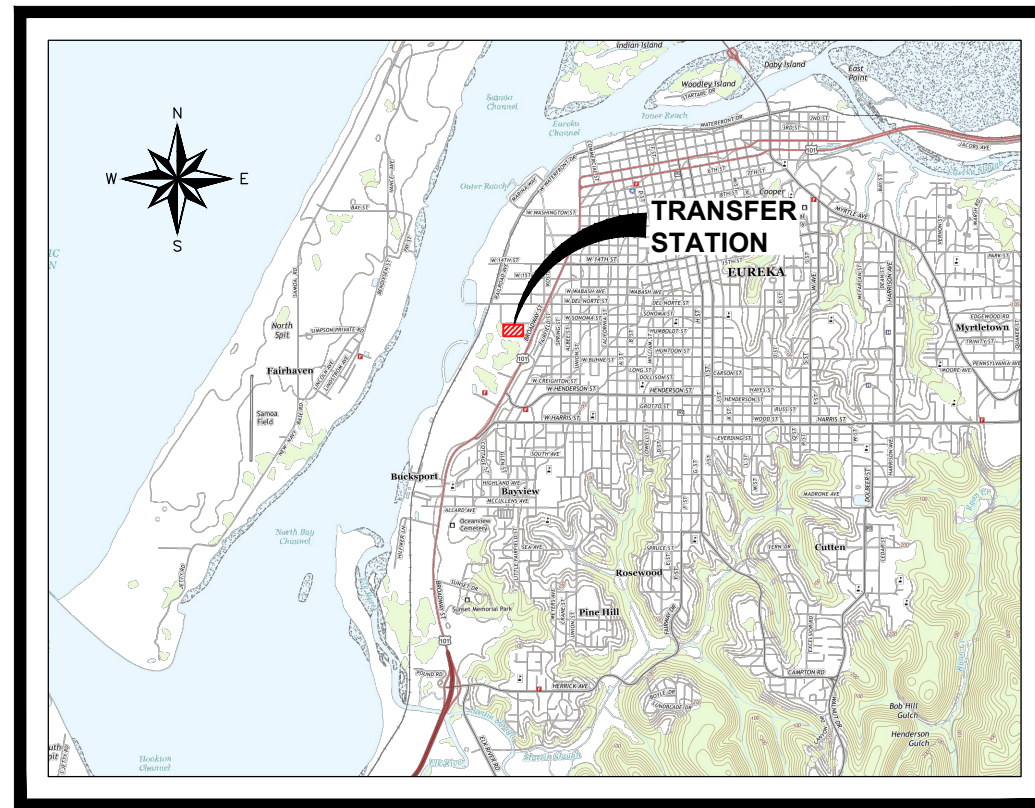
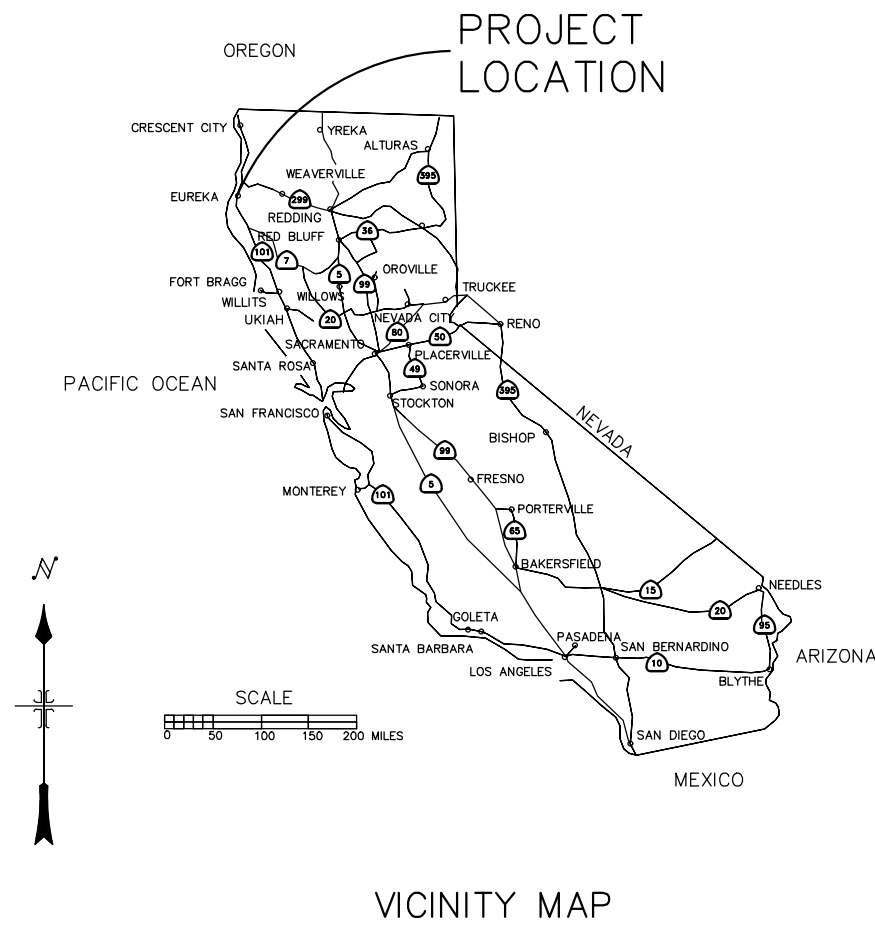

1" = 3,000'

INDEX TO DRAWINGS

DRAWING	DRAWING TITLE
	COVERSHEET & SITE LOCATION
1.0	FACILITY MAP
2.0	SITE MAP – FLOOR OVERLAY
3.0	DETAILS

PLANS PREPARED BY: LAWRENCE AND ASSOCIATES
 3590 IRON CT.
 SHASTA LAKE, CA 96019
 (530) 275-4800



PLANS PREPARED FOR: OWNER:
 HUMBOLDT WASTE
 MANAGEMENT AUTHORITY
 1059 WEST HAWTHORNE STREET
 EUREKA, CA

FOR BIDDING

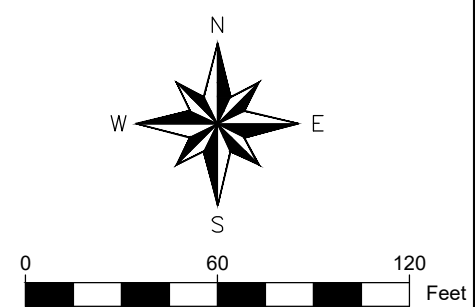
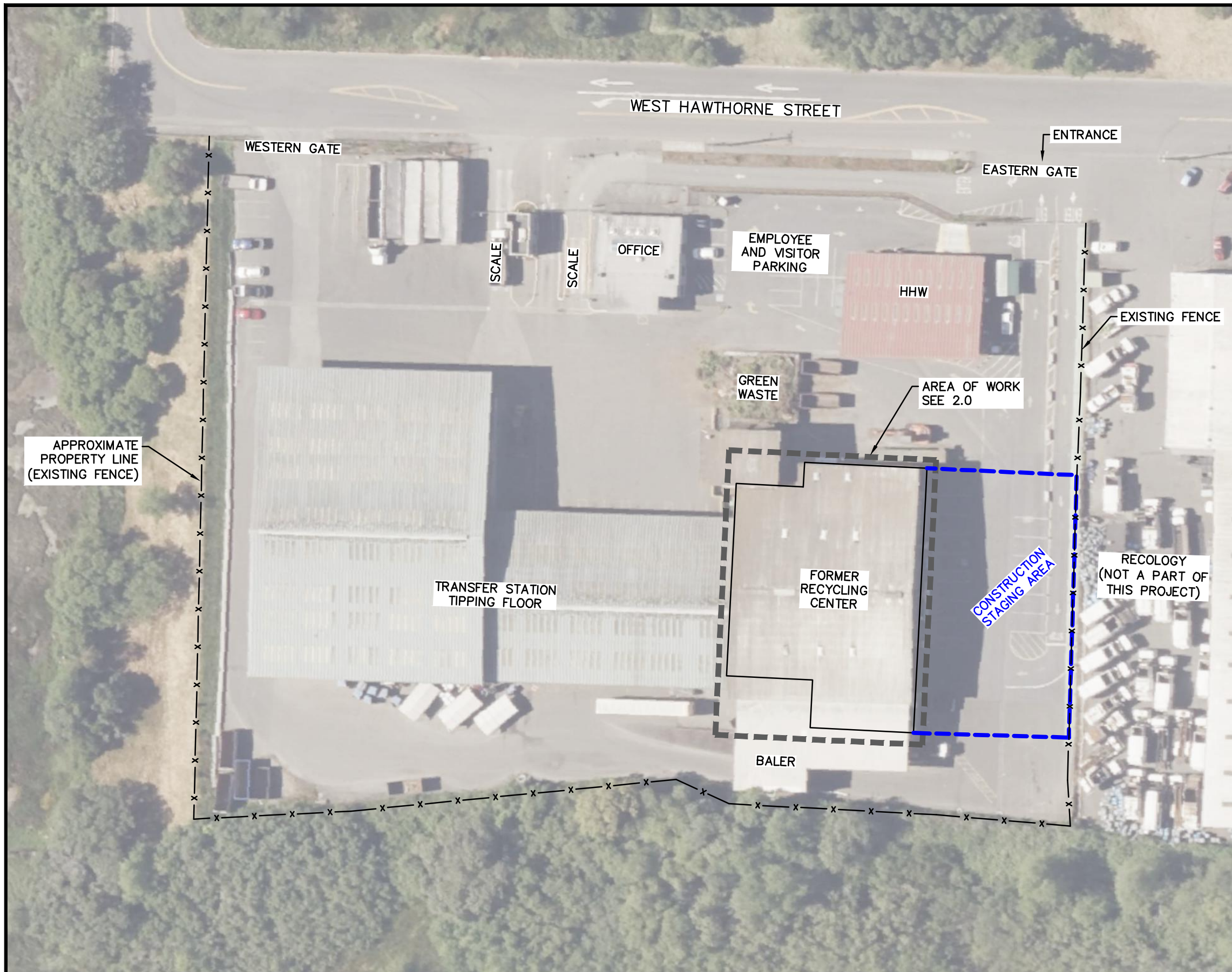

NO.	DATE	REVISIONS	BY	CHK

PROJECT NO: 021026.00	PROJECT ID:
DRAWN BY: J. BEERS	SCALE: 1" = 30'
ENGINEER: D. BROWN	DATE:
CHECKED BY:	DATE:

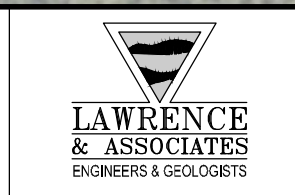
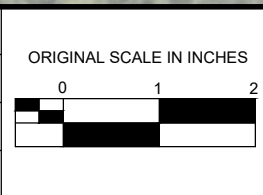

RECYCLING CENTER FLOOR REPAIR

EUREKA TRANSFER STATION

FACILITY MAP



DRAWING:	1.0
SHEET:	OF
DATE:	3/2/2023

LEGEND

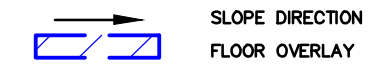

ASPHALT OVERLAY 1

1. DEEP FILL/REPAIR TO UTILIZE 4,000 PSI CONCRETE SLURRY TO MATCH EXISTING SLAB SURFACE.
2. MAINTAIN LOW POINT AS SHOWN ON DRAWING, ADD 3-INCH ASPHALT OVERLAY ON ENTIRE SURFACE (12,600 SQUARE FEET). TAPER EDGES AT EASTERN CONNECTION POINT (GRIND EXISTING SURFACE AT TRANSITION TO PROVIDE AT LEAST 2-INCH THICKNESS OF ASPHALT).
3. THIS OPTION PROVIDES A NEW OVERLAY FOR THE ENTIRE WORKING SURFACE, WITH FUTURE MAINTENANCE INCLUDING SLURRY SEAL AS NEEDED.

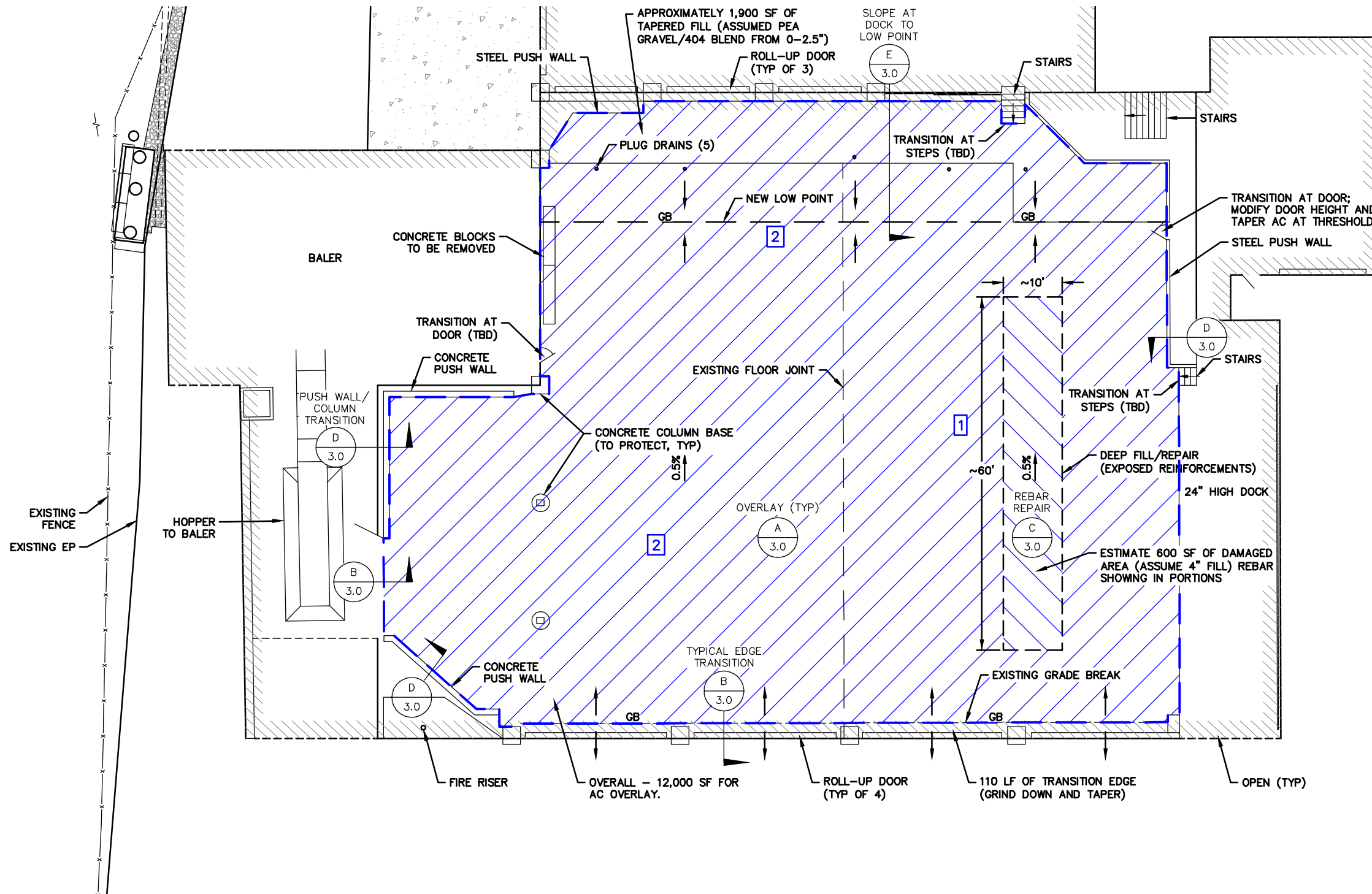

NO.	DATE	REVISIONS	BY	CHK

PROJECT NO: 021026.00	PROJECT ID:
DRAWN BY: J. BEERS	SCALE: 1" = 10'
ENGINEER: D. BROWN	DATE:
CHECKED BY:	DATE:

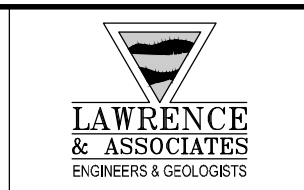
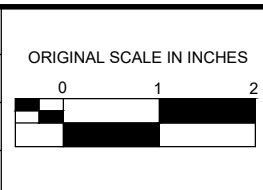

RECYCLING CENTER FLOOR REPAIR

EUREKA TRANSFER STATION

SITE MAP FLOOR OVERLAY

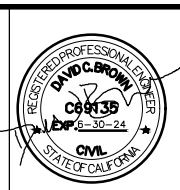

DRAWING: 2.0
SHEET: OF
DATE: 3/2/2023

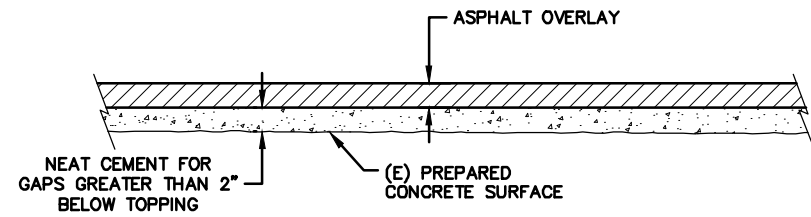

A AC OVERLAY
NTS

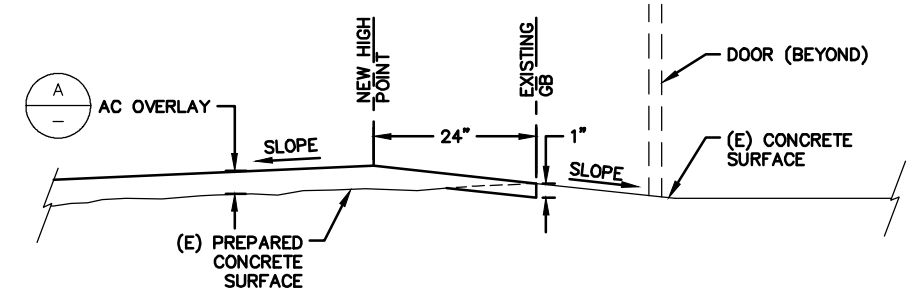

B TYPICAL EDGE TRANSITION
NTS

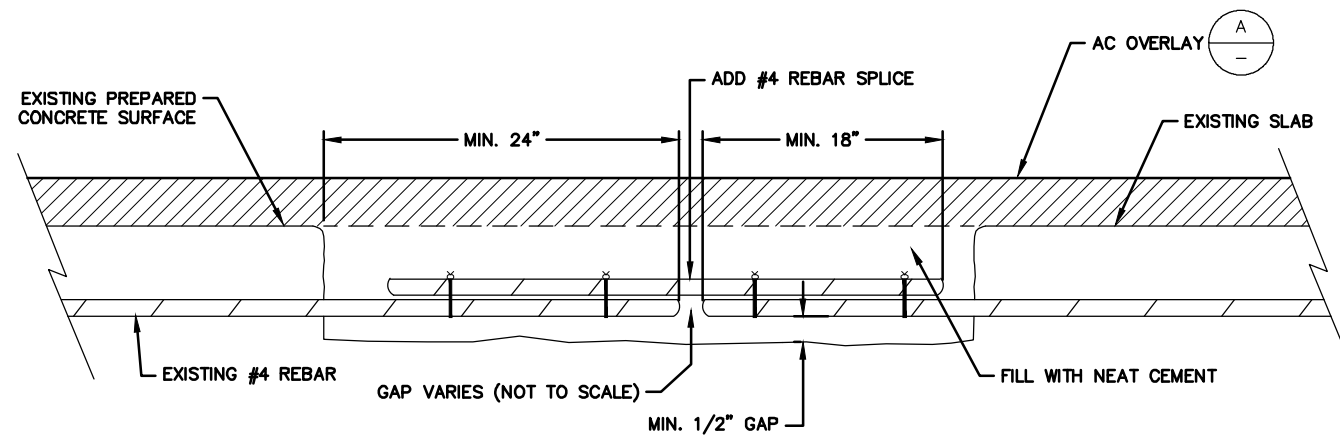

C REPAIR OF DAMAGED REBAR
NTS

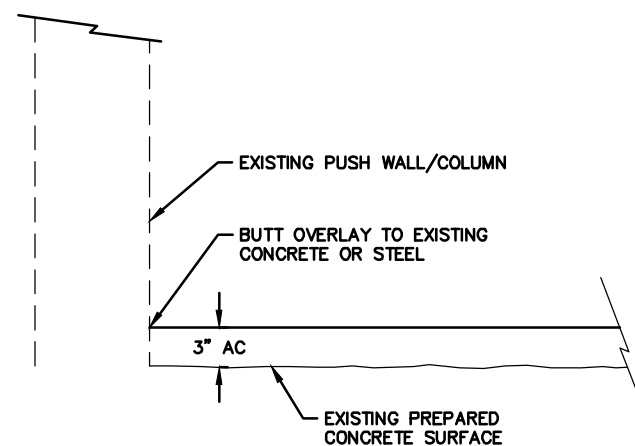

D PUSH WALL/COLUMN TRANSITION
NTS

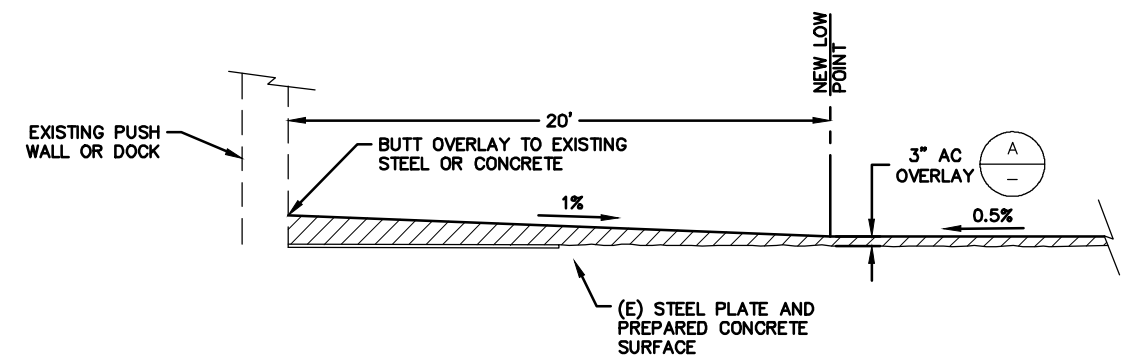

E SLOPE AT DOCK TO LOW POINT
NTS

NO.	DATE	REVISIONS	BY	CHK

PROJECT NO: 021026.00	PROJECT ID:
DRAWN BY: J. BEERS	SCALE: AS SHOWN
ENGINEER: D. BROWN	DATE:
CHECKED BY:	DATE:

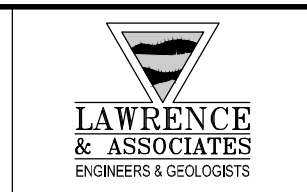
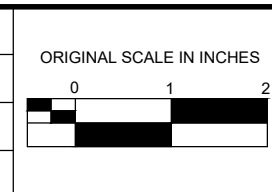

RECYCLING CENTER FLOOR REPAIR

EUREKA TRANSFER STATION

DETAILS

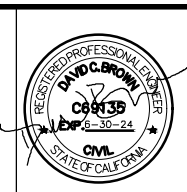

DRAWING: 3.0
SHEET: OF
DATE: 3/2/2023

SECTION 16. CONTRACT

Humboldt Waste Management Authority

CONTRACT

FOR

Organics Processing Facility Floor Repair and Overlay

THIS CONTRACT, is made this _____ day of _____, by and between Humboldt Waste Management Authority, hereinafter called the HWMA and

_____, a
_____, [legal capacity of contractor], hereinafter called the Contractor.

WITNESSETH:

WHEREAS, the HWMA has caused to be prepared in accordance with law, specifications, drawings and other Contract Documents for the work herein described and shown and has approved and adopted these Contract Documents, and has caused to be published in the manner and for the time required by law a notice to bidders inviting sealed proposals for doing the work in accordance with the terms of this contract; and

WHEREAS, the Contractor, in response to the notice to bidders, has submitted to the HWMA a sealed proposal accompanied by a proposal guaranty in an amount of not less than 10 percent of the bid price for the construction of the proposed work in accordance with the terms of this contract; and

WHEREAS, the HWMA, in the manner prescribed by law, has publicly opened, examined and canvassed the proposals submitted and as a result has determined and declared the Contractor to be the lowest responsible bidder for the work and for the sums named in the proposal.

NOW, THEREFORE, for valuable consideration the sufficiency of which is acknowledged, the Parties agree as follows:

Article I. Work to be Done and Contract Days Allowed.

Contractor shall provide all necessary machinery, tools, apparatus and other means of construction; shall furnish all materials, superintendence, overhead, expenses, all labor and expenses of whatever nature necessary for completion of the work in conformity with the Special Provisions and other contract documents hereto attached and according to such instructions as may be given by the Engineer. The Contractor shall complete all of the work described in this contract except as allowed in the Technical Specifications within ninety (90) calendar days. Contract days shall be counted starting with the 10th day following receipt of notice that the contract has been executed by the HWMA. Contractor, at his or her option, may begin work prior to start of counting contract days, however, in no event shall the Contractor start work without giving notification to the Owner and Engineer as indicated in Section 9-02, or without having submitted certificates of insurance that have been accepted and approved by the HWMA. The Contractor will pay to the HWMA the sum of five hundred (\$500.00) dollars per day for each and every working day delay beyond the time prescribed.

Article II. Contract Prices.

That the HWMA shall pay the Contractor the prices stated in the Proposal submitted by the Contractor, for complete performance of the work by the Contractor. The Contractor hereby agrees to accept the prices as full compensation for all material and appliances necessary to the work, for all labor and use of tools and other implements necessary to execute the work contemplated in this contract; for all loss or damage arising out of the nature of the work or from the action of the elements, or from any unforeseen obstructions or difficulties which may be encountered in the prosecution of the

work; for all risks of every description connected therewith; for all expenses of the work, as herein specified; for all liability and other insurance, for all overhead and other expenses incident to the work; all according to the Contract Documents, the instructions and the requirements of the HWMA.

Article III. Labor Discrimination.

Attention is directed to Section 1735 of the Labor Code, which reads as follows:

"No discrimination shall be made in the employment of persons upon public works because of the race, color, national origin or ancestry, or religion of such persons and every contractor for public works violating this section is subject to all the penalties imposed for a violation of this chapter."

In connection with the performance of work under this contract, the Contractor agrees as follows:

- (a) The Contractor will not willfully discriminate against any employee or an applicant for employment because of race, color, religion, ancestry, or national origin. The Contractor will take affirmative action to ensure that applicants are employed and that employees are treated during employment without regard to their race, color, religion, ancestry, or national origin. Such action shall include, but not be limited to, the following: employment, upgrading, demotion or transfer; recruitment or recruitment advertising; layoff or termination; rates of pay or other forms of compensation; and selection for training, including apprenticeship. The Contractor agrees to post in conspicuous places, available to employees and applicants for employment, notices to be provided by the awarding authority setting forth the provisions of this Fair Employment Practice section.
- (b) The Contractor will send to each labor union or representative of workers with which he or she has a collective bargaining agreement or other contract or understanding, a notice, to be provided by the awarding authority, advising the said labor union or worker's representative of the Contractor's commitments under this section, to employees and applicants for employment.
- (c) The Contractor will permit access to his or her records of employment, employment advertisements, application forms and other pertinent data and records by the Fair Employment Practices Commission, HWMA or any other appropriate HWMA of the State of California designated by the awarding authority, for the purposes of investigation to ascertain compliance with the Fair Employment Practices section of this contract.
- (d) A finding of willful violation of the Fair Employment Practices section of this Contract or of the Fair Employment Practices Act shall be regarded by the awarding authority as a basis for determining the Contractor to be not a "responsible bidder" as to future contracts for which such Contractor may submit bids, for revoking the Contractor's pre-qualification rating, if any and for refusing to establish, reestablish or renew a pre-qualification rating for the Contractor.

The Humboldt Waste Management Authority shall deem a finding of willful receipt of written notice from the Fair Employment Practices Act to have occurred upon that it has investigated and determined that the Contractor has violated the Fair Employment Practices Act and has issued an order under Labor Code Section 1426 or obtained an injunction under Labor Code Section 1429.

Upon receipt of such written notice from the Fair Employment Practices Commission, the Humboldt Waste Management Authority shall notify the Contractor that unless he or she demonstrates to the satisfaction of the awarding authority within a stated period that the violation has been corrected, his or her pre-qualification rating will be revoked at the expiration of such period.

- (e) The Contractor agrees that should the HWMA determine that the Contractor has not complied with the Fair Employment Practices section of this Contract, then pursuant to Labor Code Section 1735 and 1775 the Contractor shall, as a penalty to the HWMA, forfeit for each calendar day or portion thereof, for each person who was denied employment as a result of such non-compliance, the penalties provided in the Labor Code for violation of prevailing wage rates. Such monies may be recovered from the Contractor. The HWMA may deduct any such damages from any monies due the Contractor.

- (f) Nothing contained in this Fair Employment Practices section shall be construed in any manner of fashion so as to prevent the HWMA or the State of California from pursuing any other remedies that may be available at law.
- (g) Prior to awarding the Contract, the Contractor shall certify to the awarding authority that he or she has or will meet the following standards for affirmative compliance, which shall be evaluated in each case by the awarding authority:
 - (1) The Contractor shall provide evidence, as required by the HWMA that he or she has notified all supervisors, foremen and other personnel officers in writing of the content of the anti-discrimination clause and their responsibilities under it.
 - (2) The Contractor shall provide evidence, as required by the HWMA, that he or she has notified all sources of employees referrals (including unions, employment agencies, advertisements, Department of Employment) of the content of the anti-discrimination clause.
 - (3) The Contractor shall file a basic compliance report, as required by the HWMA. Willfully false statements made in such reports shall be punishable as provided by law. The compliance report shall also spell out the sources of the work force and who has the responsibility for determining whom to hire, or whether or not to hire.
 - (4) Personally, or through his or her representatives, the Contractor shall, through negotiations with the unions with whom he or she has agreements, attempt to develop an agreement which will:
 - a. Spell out responsibilities for nondiscrimination in hiring, referral, upgrading and training.
 - b. Otherwise implement an affirmative anti-discrimination program in terms of the unions' specific areas of skill and geography to the end that qualified minority workers will be available and given and equal opportunity for employment.
 - (5) The Contractor shall notify the HWMA of opposition to the anti-discrimination clause by individuals, firms or organizations during the period of its pre-qualification.
- (h) The Contractor will include the provisions of the foregoing paragraphs 1 through 5 in every first tier subcontract so that such provisions will be binding upon each such subcontractor.
- (i) The "Fair Employment Practices Certification" must be completed and signed prior to the time of submitting the bid.

Article IV. Contract Documents.

The Contract Documents are defined in Section 1-01 of the General Conditions. All Contract Documents shall be considered a part of this agreement.

IN WITNESS WHEREOF, this Contract being executed in triplicate and the parties having caused their names to be signed by authority of their duly authorized office this _____ day of _____,
HUMBOLDT COUNTY, CALIFORNIA

By: _____
Board Chair or Executive Director, Humboldt Waste Management Authority

Attest: _____
Board Clerk, Humboldt Waste Management Agency

By: _____
CONTRACTOR

Attest: _____

Title: _____

The foregoing Contract is approved as to form and legality this _____ day of _____, 20____.

Approved as to Form: Counsel for Humboldt Waste Management Authority

**Humboldt Waste Management Authority
For
Organics Processing Facility Floor Repair and Overlay**

FAITHFUL PERFORMANCE BOND

KNOW ALL MEN BY THESE PRESENTS,

that we the undersigned, _____

_____, **AS PRINCIPAL,** and

_____, **AS SURETY,**

are held firmly bound unto Humboldt Waste Management Authority, hereinafter called the "HWMA", in the penal sum of

_____ dollars (\$ _____)

for the payment of which sum we bind ourselves, our heirs, executors, administrators, and successors, jointly and severally.

WHEREAS, the Principal has entered into a certain Contract with the HWMA, dated _____, 20____, a copy of which is hereto attached and made a part hereof,

NOW, THEREFORE, the condition of this obligation is such that if the Principal shall in all respects fully perform the Contract and all duly authorized modifications thereof, during its original term and any extensions thereof that may be granted and during any guaranty period for which the Contract provides, and if the Principal shall fully satisfy all claims, arising out of the prosecution of the work under the Contract and shall fully indemnify the HWMA for all expenses which it may incur by reason of such claims, including its attorney's fees and court costs, and if the Principal shall make full payment to all persons supplying labor, services, materials, or equipment in the prosecution of the work under the Contract, in default of which such persons shall have a direct right of action hereupon; and if the Principal shall pay or cause to be paid all sales and use taxes payable as a result of the performance of the Contract as well as payment of gasoline and special motor fuels taxes in the performance of the Contract and all motor vehicle fees required for commercial motor vehicles used in connection with the performance of the Contract, then this obligation shall be void; otherwise, it shall remain in full force and effect. No modification of the Contract or extension of the term thereof, nor any forbearance on the part of the HWMA shall in any way release the Principal or the Surety from liability hereunder. Notice to the Surety of any such modification, extension, or forbearance is hereby waived.

IN WITNESS WHEREOF, the aforesaid Principal and Surety have executed this instrument and affixed their seals hereto, this _____ day of _____, 20_____.

In the presence of:

WITNESS:

(Individual Principal) (SEAL)

(Business Address)

(City/State/Zip Code)

WITNESS:

_____ (SEAL)
_____ (Corporate Principal)

(Business Address)

(City/State/Zip Code)

ATTEST:

_____ Affix
_____ (Corporate Principal)

Corporate Seal

(Business Address)

(City/State/Zip Code)

ATTEST:

_____ Affix
_____ (Corporate Surety)

Corporate Seal

(Business Address)

(City/State/Zip Code)

The rate of premium on this bond is \$ _____ per thousand.

The total amount of premium charges is \$ _____.

(The above is to be filled in by Surety Company). (Power of Attorney of person signing for Surety Company must be attached).

(CERTIFICATE AS TO CORPORATE PRINCIPAL)

I, _____, certify that I am the _____ Secretary of the corporation named as Principal in the foregoing bond; that _____, who signed the said bond on behalf of the Principal, was then _____ of said corporation; that I know his signature, and that his signature thereto is genuine; and that said bond was duly signed, sealed, and attested to for and in behalf of said corporation by authority of its governing body.

_____ Affix Corporate Seal

**Humboldt Waste Management Authority
For
Organics Processing Facility Floor Repair and Overlay**

MATERIAL AND LABOR BOND

KNOW ALL MEN BY THESE PRESENTS,

that we the undersigned, _____

_____, **AS PRINCIPAL,** and

_____, **AS SURETY,**

are held firmly bound unto Humboldt Waste Management Authority, hereinafter called the "HWMA", in the penal sum of

_____ dollars (\$_____)

for the payment of which sum we bind ourselves, our heirs, executors, administrators, and successors, jointly and severally.

WHEREAS, the Principal has entered into a certain Contract with the HWMA, dated _____, 20____, a copy of which is hereto attached and made a part hereof,

NOW, THEREFORE, the condition of this obligation is such that if the Principal shall in all respects fully perform the Contract and all duly authorized modifications thereof, during its original term and any extensions thereof that may be granted and during any guaranty period for which the Contract provides, and if the Principal shall fully satisfy all claims, arising out of the prosecution of the work under the Contract and shall fully indemnify the HWMA for all expenses which it may incur by reason of such claims, including its attorney's fees and court costs, and if the Principal shall make full payment to all persons supplying labor, services, materials, or equipment in the prosecution of the work under the Contract, in default of which such persons shall have a direct right of action hereupon; and if the Principal shall pay or cause to be paid all sales and use taxes payable as a result of the performance of the Contract as well as payment of gasoline and special motor fuels taxes in the performance of the Contract and all motor vehicle fees required for commercial motor vehicles used in connection with the performance of the Contract, then this obligation shall be void; otherwise, it shall remain in full force and effect. No modification of the Contract or extension of the term thereof, nor any forbearance on the part of the HWMA shall in any way release the Principal or the Surety from liability hereunder. Notice to the Surety of any such modification, extension, or forbearance is hereby waived.

IN WITNESS WHEREOF, the aforesaid Principal and Surety have executed this instrument and affixed their seals hereto, this _____ day of _____, 20_____.

In the presence of:

WITNESS:

(Individual Principal) (SEAL)

(Business Address)

(City/State/Zip Code)

WITNESS:

(Corporate Principal) (SEAL)

(Business Address)

(City/State/Zip Code)

ATTEST:

(Corporate Principal) Affix Corporate Seal

(Business Address)

(City/State/Zip Code)

ATTEST:

(Corporate Surety) Affix Corporate Seal

(Business Address)

(City/State/Zip Code)

The rate of premium on this bond is \$ _____ per thousand. The total amount of premium charges is \$ _____.

(The above is to be filled in by Surety Company). (Power of Attorney of person signing for Surety Company must be attached).

(CERTIFICATE AS TO CORPORATE PRINCIPAL)

I, _____, certify that I am the _____ Secretary of the corporation named as Principal in the foregoing bond; that _____, who signed the said bond on behalf of the Principal, was then _____ of said corporation; that I know his signature, and that his signature thereto is genuine; and that said bond was duly signed, sealed, and attested to for and in behalf of said corporation by authority of its governing body.

_____ Affix Corporate Seal

DIRECTIONS FOR PREPARATION OF PERFORMANCE BOND AND MATERIAL AND LABOR BOND

1. Individual sureties, partnerships, or corporations not in the surety business will not be acceptable.
2. The name of the Principal shall be shown exactly as it appears in the Contract.
3. The penal sum shall not be less than required by the Specifications.
4. If the Principals are partners or joint ventures, each member shall execute the bonds as an individual and state his place of residence.
5. If the Principal is a corporation, the bonds shall be executed under its corporate seal. If the corporation has no corporate seal, it shall so state and affix a scroll or adhesive seal following the corporate name.
6. The official character and authority of the person(s) executing the bonds for the Principal, if a corporation, shall be certified by the Secretary or Assistant Secretary thereof under the corporate seal, or copies attached to such records of the corporation as will evidence the official character and authority of the officer signing, duly certified by the Secretary or Assistant Secretary, under the corporate seal, to be true copies.
7. The current power-of-attorney of the person signing for the surety company must be attached to the bonds.
8. The date of the bonds must not be prior to the date of the Contract.
9. The following information must be placed on the bonds by the surety company:
 - a. The rate of premium in dollars per thousand; and
 - b. The total dollar amount of premium charged.
10. The signature of a witness shall appear in the appropriate place attending to the signature of each party of the bonds.
11. Type or print the name underneath each signature appearing on the bonds.
12. An executed copy of the bonds must be attached to each copy of the Contract (original counterpart) intended for signing.

**Humboldt Waste Management Authority
For
Organics Floor Repair and Overlay.**

DEFECTIVE MATERIAL AND WORKMANSHIP (MAINTENANCE) BOND

KNOW ALL MEN BY THESE PRESENTS,

that we, _____
_____, as **PRINCIPAL**

and _____
_____, as **SURETY,**

are held and firmly bound unto the as Obligee, in the penal sum of

_____, (\$ _____),
(15 PERCENT OF THE TOTAL AMOUNT OF THE BID)

to which payment well and truly to be made, we do bind ourselves, our and each of our heirs, executors, administrators successors and assigns jointly and severally, firmly by these presents.

WHEREAS, the said Principal entered into a Contract with the Humboldt Waste Management Authority dated _____
for _____

WHEREAS, said Contract has been completed, and was approved on the _____ day of _____, 20 _____,

NOW, THEREFORE, THE CONDITION OF THIS OBLIGATION IS SUCH, that if the Principal shall guarantee that the work will be free of any defective materials or workmanship which become apparent during the period of one (1) year following completion of the Contract, then this obligation shall be void, otherwise to remain in full force and effect, provided however, any additional warranty or guarantee whether expressed or implied is extended by the Principal or Manufacturer only, and the surety assumes no liability for such a guarantee.

Signed, sealed, and dated this _____ day of _____, 20_____.

(Seal)

BY: _____ (Seal)

(Seal)

Principal

(Seal)

BY: _____ (Seal)

(Seal)

Surety

PROPOSAL FORMS

Print, Fill-Out, and Submit These Forms

**HUMBOLDT WASTE MANAGEMENT AUTHORITY
PROPOSAL
FOR
Organics Processing Facility Floor Repair and Overlay**

The undersigned, as Bidder, declares that he or she has examined thoroughly all of the Contract Documents herein contained, that this proposal is made without collusion with any other person, firm or corporation and that all laws and ordinances relating to the interest of public officers in this contract have been complied with in every respect.

AND he or she proposes and agrees, if this proposal is accepted,

1) that he or she will contract with the Humboldt Waste Management Authority, California, in the form of the copy of the agreement herein contained

a) to provide all necessary machinery, tools, apparatus and other means of construction;

b) to furnish all materials;

c) to provide all superintendence, overhead expenses and all labor and expenses of whatever nature necessary to complete the job in conformity with the specifications and drawings and other contract provisions herein or reasonably implied hereby or as necessary to complete the work in the manner and within the time named herein and according to the requirements and to the reasonable satisfaction of the HWMA;

d) to pay all charges of freight transportation and hauling;

2) that he or she indemnifies the HWMA against any loss or damage arising from any act of the undersigned as Contractor; and

3) that he or she will accept as full payment therefor the following sums:

BID SCHEDULE
FOR
ORGANICS PROCESSING FACILITY FLOOR REPAIR AND OVERLAY

Bid Item No.	Description ^{1,2}	Quan.	Unit	Unit Price	Total Price
General Requirements					
1	Mobilization	LS	1		
2	Coordination	LS	1		
3	Health and Safety	LS	1		
4	Field Engineering	LS	1		
Floor Repair					
5	Repair Heavy Wear Area (exposed rebar)	SF	600		
6	Asphalt overlay (3" thickness)	SF	12,600		
7	Binder between AC and Slab	SF	12,600		
8	Transition new overlay to existing (south edge)	LF	110		

Notes:

All – See contract specifications and plans. Floor repair cost shown includes all cleaning preparation, installation, and cleanup

⁵ Item assumes 4" average fill below topping overlay and 100 LF of 1/2" rebar slice bars.

⁶ Taper shown at 4" on plans including topping overlay. This item is only 2-1/2" tapered fill (below the topping layer).

^{5,6} Fill material in these areas assumes 50% (by volume) pea gravel and 50% euco 404 mix

BIDDER: _____

TOTAL PRICE (Numerical, total of items 1-6):

TOTAL IN WORDS:

We, the undersigned, acknowledge that the HWMA reserves the right to reject any or all bids or to select the base bid plus any additive item or combination of additive items and to determine which proposal is, in its opinion, the lowest responsive bid of a responsible bidder and that which it deems to be in the best interest of the HWMA to accept. The HWMA also reserves the right to waive any information not material to cost or performance in any proposal or bid and further agree, if this proposal shall be accepted, to sign the agreement and to furnish the required bonds with satisfactory surety, or sureties, within fifteen (15) calendar days after written notice that the contract is ready for signature; and, if the undersigned shall fail to contract, as aforesaid, it shall be understood that he or she has abandoned the contract and that, therefore, this proposal shall be null and void and the proposal guaranty accompanying this proposal, or the amount of said guaranty, shall be forfeited to and become the property of the HWMA. Otherwise, the proposal guaranty accompanying this proposal shall be returned to the undersigned.

Witness our hands this day of _____, 2023.

Licensed in accordance with an act providing for the registration of Contractor's License No.

_____, expiration date _____.

THE CONTRACTOR'S LICENSE NUMBER AND EXPIRATION DATE STATED HEREIN ARE MADE UNDER PENALTY OF PERJURY.

Signature of bidder or bidders, with business addresses:

Notice: In the case of a corporation, give below the addresses of the principal office thereof and names and addresses of the President, Secretary, Treasurer.

ACKNOWLEDGEMENT OF ADDENDA

The undersigned acknowledges that the Bidder has received the following addenda by initialing the line adjacent to the addendum number (if any). Add lines if necessary:

Addendum 1: _____

Addendum 2: _____

Addendum 3: _____

FAIR EMPLOYMENT PRACTICES CERTIFICATION

TO: _____

The undersigned, in submitting a bid for performing the following work by Contract, hereby certifies that he or she has or will meet the standards of affirmative compliance with the Fair Employment Practices requirements of the Special Provisions contained herein.

Organics Processing Facility Floor Repair and Overlay

(Signature of Bidder)

Business Address:

Place of Residence:

(The bidder shall execute the certification of this page prior to submitting his or her proposal.)

WORKER'S COMPENSATION CERTIFICATE

I am aware of the provisions of Section 3700 of the Labor Code which require every employer to be insured against liability for Worker's Compensation or undertake self-insurance in accordance with the provisions of that code and I will comply with such provisions before commencing the performance of the work of this contract.

Witness my hand this _____ day of _____, 20 ____

Signature of Bidder, with Business Address:

CERTIFICATION OF NONDISCRIMINATION IN EMPLOYMENT

The bidder represents that he or she has/has not, participated in a previous contract or subcontract subject to either the equal opportunity clause herein or the clause contained in Section 301 of Executive Order 10925; that he or she has/has not, filed all required compliance reports; and that representations indicating submission of required compliance prior to subcontract awards.

Signature and address of Bidder:

_____ Date _____

(This certification shall be executed by the bidder in accordance with Section 60-1.6 of the Regulations of the President's Committee on Equal Employment Opportunity for implementing Executive Orders 10925 and 11114.)

LIST OF PROPOSED SUBCONTRACTORS

In compliance with the provisions of Sections 4100-4108 of the State Government Code and any amendments thereof, refer to Section 1-09 of the Special Provisions within these Contract Documents which include, but are not limited to: The name and the location of the place of business, the California contractor license number (CSLB), and public works contractor registration number issued pursuant to Section 1725.5 of the Labor Code (DIR) of each subcontractor who will perform work or labor or render service to the prime contractor in or about the construction of the work or improvement, or to a subcontractor licensed by the State of California who, under subcontract to the prime contractor, specially fabricates and installs a portion of the work according to detailed drawings contained in the Plans and Special Provisions, in an amount in excess of one-half of 1 percent of the prime contractor's total bid. This form **MUST** be completed and submitted with the Bid Proposal from the Contractor. Attach multiple copies of this sheet, if needed.

Scope	Subcontractor Name	Address	CSLB #	DIR #

STATEMENT OF EXPERIENCE OF BIDDER

The bidder is required to state below what work of similar magnitude or character he or she has done and to give references that will enable the HWMA to judge of his or her experience, skill and business standing and his or her ability to conduct work as completely and rapidly as required under the terms of the contract.

1) General Information

Submitter Name: _____

Federal Tax ID No. _____

Company Name: _____

Company Owner Name: _____

Corporation: List corporation number, State, and date of incorporation

Partnership: list name and address of each partner

Company Mailing Address: _____

Telephone Number(s): _____

Fax Number: _____

E-Mail Address: _____

SIGNATURE(S) OF BIDDER

Accompanying this proposal is _____
(insert the words "cash (\$)", "cashier's check" or "bidder's bond", as the case may be) in an amount equal to at least 10 percent of the bid.

The names of all persons interested in the foregoing proposal as principals are as follows:

IMPORTANT NOTICE: If bidder or other interested person is a corporation, provide the legal name of corporation and also the names of the president, secretary, treasurer and manager thereof. If a co-partnership, provide the true name of firm and also the names of all individual co-partners composing the firm. If bidder or other interested person is an individual, provide the first and last names in full.

Licensed in accordance with an act providing for the registration of Contractors:

License No. _____.

Signature(s) of Bidder: _____

NOTE: If bidder is a corporation, the legal name of the corporation shall be set forth above together with the signature of the officer or officers authorized to sign contracts on behalf of the corporation; if bidder is a co-partnership, the true name of the firm shall be set forth above together with the signature of the partner or partners authorized to sign contracts in behalf of the co-partnership; and if bidder is an individual, his or her signature shall be placed above. If a member of a partnership, a Power of Attorney must be on file with the Department prior to opening bids or submitted with the bid; otherwise, the bid will be disregarded as irregular and unauthorized.

Business address: _____

Place of residence: _____

Dated _____

**Humboldt Waste Management Authority
Organics Processing Facility Floor Repair and Overlay**

BIDDER'S BOND

KNOW ALL MEN BY THESE PRESENTS,

that we, _____

_____, as PRINCIPAL and

_____, as SURETY,

are held and firmly bound unto Humboldt Waste Management Authority (HWMA) in the penal sum of 10 PERCENT OF THE TOTAL AMOUNT OF THE BID of the Principal above named, submitted by said Principal to Humboldt Waste Management Authority, as the case may be, for the work described below, for the payment of which sum in lawful money of the United States, well and truly to be made, to the HWMA Clerk to which said bid was submitted, we bind ourselves, our heirs, executors, administrators and successors jointly and severally, firmly by these presents. In no case shall the liability of the surety hereunder exceed the sum of \$ _____

THE CONDITION OF THIS OBLIGATION IS SUCH,

that whereas the Principal has submitted the above mentioned bid to the Humboldt Waste Management Authority, as aforesaid, for certain construction specifically described as follows, for which bids are to be opened at the HWMA Office, 1059 West Hawthorne Street, Eureka, California, for **Organics Processing Facility Floor Repair and Overlay**

NOW, THEREFORE, If the aforesaid Principal is awarded the contract and, within the time and manner required under the specifications, after the prescribed forms are presented to him or her for signatures, enters into a written contract, in the prescribed form, in accordance with the bid and files two bonds with Humboldt Waste Management Authority one to guarantee faithful performance and the other to guarantee payment for labor and materials, as required by law, then this obligation shall be null and void; otherwise, it shall be and remain in full force and virtue.

IN WITNESS WHEREOF, we have hereunto set our hands and seals on this _____ day of _____, A.D. 20 _____.

(Seal)

(Seal)

(Seal)

Principal

(Seal)

(Seal)

(Seal)

Surety

Address: _____

**Humboldt Waste Management Authority
Organics Processing Facility Floor Repair and Overlay**

NONCOLLUSION DECLARATION TO BE EXECUTED BY BIDDER AND SUBMITTED WITH BID

The undersigned declares:

I am the _____ of _____, the party making the foregoing bid.

The bid is not made in the interest of, or on behalf of, any undisclosed person, partnership, company, association, organization, or corporation. The bid is genuine and not collusive or sham. The bidder has not directly or indirectly induced or solicited any other bidder to put in a false or sham bid. The bidder has not directly or indirectly colluded, conspired, connived, or agreed with any bidder or anyone else to put in a sham bid, or to refrain from bidding. The bidder has not in any manner, directly or indirectly, sought by agreement, communication, or conference with anyone to fix the bid price of the bidder or any other bidder, or to fix any overhead, profit, or cost element of the bid price, or of that of any other bidder. All statements contained in the bid are true. The bidder has not, directly or indirectly, submitted his or her bid price or any breakdown thereof, or the contents thereof, or divulged information or data relative thereto, to any corporation, partnership, company, association, organization, bid depository, or to any member or agent thereof, to effectuate a collusive or sham bid, and has not paid, and will not pay, any person or entity for such purpose.

Any person executing this declaration on behalf of a bidder that is a corporation, partnership, joint venture, limited liability company, limited liability partnership, or any other entity, hereby represents that he or she has full power to execute, and does execute, this declaration on behalf of the bidder.

I declare under penalty of perjury under the laws of the State of California that the foregoing is true and correct and that this declaration is executed on _____ [date], at _____ [city], _____ [state].

Signature of Declarant, with Business Address:

End of Proposal Forms