



PRODUCT INSTALLATION GUIDE



PRODUCT:	<i>LEFT HAND REAR DOOR - FOLD DOWN TABLE</i>
VEHICLE:	<i>TO SUIT - TOYOTA LANCRUISER - 78 SERIES</i>
PRODUCT NO.	<i>OTA-78-2022-006</i>

TOOLS/ITEMS REQUIRED FOR FITTING:

- PHILIPS HEAD SCREWDRIVER
- HANDHELD DRILL
- 7mm DRILL BIT
- RIVNUT DRILL ATTACHMENT OR GUN
- 4mm ALLEN KEY (SOCKET RECOMMENDED)
- SOCKET WRENCH (RECOMMENDED)
- RUST PROOF COATING/PAINT
- MARKER PEN
- RULER/SMALL STRAIGHT EDGE
- TAPE MEASURE
- METAL SHEERS OR GRINDER

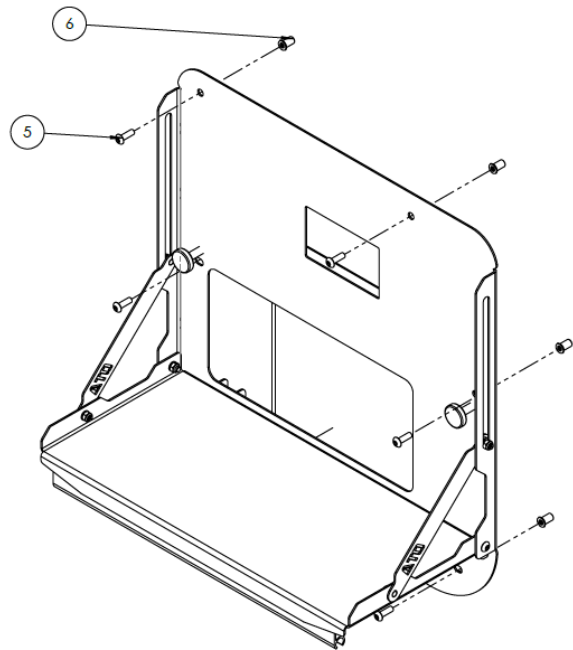

ITEM NO.	DESCRIPTION	QTY	PART NUMBER
PART LIST			
1	LEFT HAND REAR DOOR - FOLD DOWN TABLE	1	OTA78-2022-006

FITTING KIT - SUPPLIED			
ITEM NO.	DESCRIPTION	QTY	PART NUMBER
2	M5 - RIVNUT	6	-
3	M5 - BLACK BUTTON HEAD BOLTS	6	-

FOR PRODUCT WARRANTY PLEASE REFER TO OUR WEBSITE - www.micktighe4x4.com.au/

OVERLAND TOURERS AUSTRALIA

STEP 01:

- BEGIN BY REMOVING THE CLIPS FROM THE DOOR CARD. SLOWLY AND CAREFULLY WORK YOUR WAY AROUND THE EDGE AND POP EACH CLIP OUT UNTIL THE DOOR CARD HAS RELEASED.

STEP 02:

- NEXT IS TO REMOVE THE DOOR HANDLE. USING THE PHILIPS HEAD SCREW DRIVER REMOVE THE SINGLE SCREW FROM THE MIDDLE OF THE HANDLE (ENSURE THE SCREW IS STORED SOMEWHERE WHERE IT WON'T BE LOST)



STEP 03:

- WITH THE SCREW REMOVED, PUSH THE HANDLE IN AND SLIDE TO THE RIGHT. THIS WILL POP THE HANDLES CLIPS FROM THEIR SLOTS.

- NEXT USING YOUR SCREWDRIVER OR A LONG, SKINNY TOOL, PUSH AGAINST THE GREEN CLIP TO UNCLIP IT FROM THE ROD. THIS WILL FULLY RELEASE THE HANDLE AND THE DOOR CARD

NOTE: REMOVE THE PLASTIC LINING FROM THE DOOR BEFORE CONTINUING.

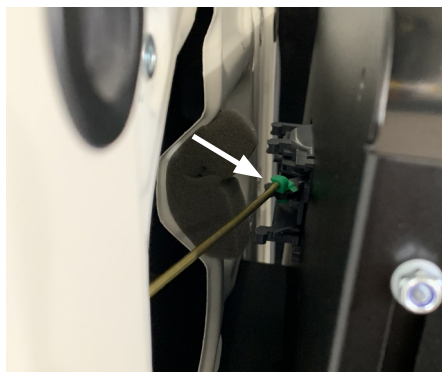

STEP 04:

ON THE OTA WEBSITE ALONG WITH THESE INSTALLATION INSTRUCTIONS IS A DOWNLOADABLE PDF WHICH HAS THE CUT-OUT TEMPLATE FOR THIS TABLE. PRINT THE REQUIRED PAGES, CUT THE OUTLINES OF THE TABLE AND THE INTERNAL CUT-OUT, THEN TAPE TOGETHER THE FOUR SECTIONS TO CREATE THE TEMPLATE.

USING THE TEMPLATE, ALIGN IT TO THE MOUNTING POINTS AND MARK THE CUTTING LINES.



STEP 05:

WITH THE LINES NOW MARKED IN PLACE, USE A GRINDER OR METAL SHEERS TO CAREFULLY CUT OUT THE SECTION AS MARKED (CHECK AND ENSURE ANY WIRING OR INTERNAL COMPONENTS WILL NOT BE DAMAGED WHILST CUTTING)

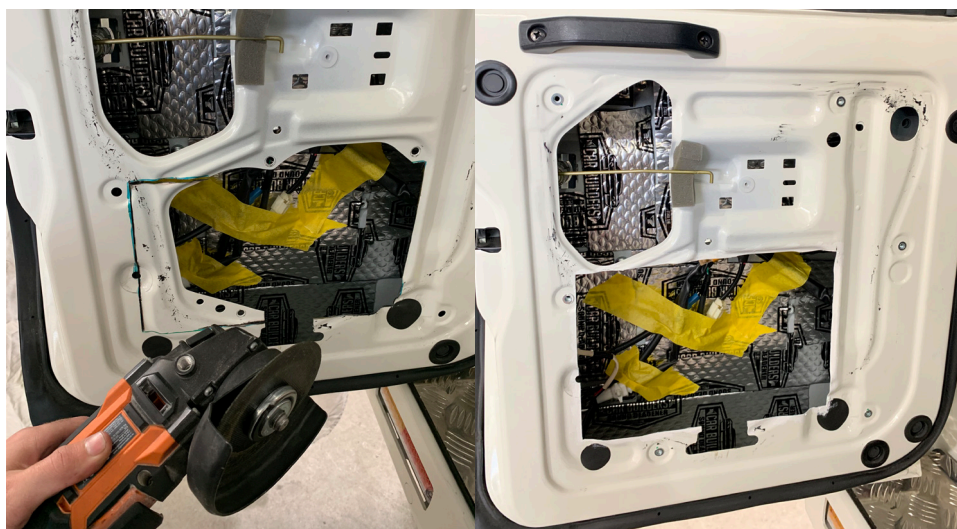

STEP 06:

WITH THE SECTION NOW CUT OUT, BLOW OR VACCUM ANY SWARF/METAL SHAVINGS THAT MAY BE LEFT INSIDE THE DOOR.

- USING A METAL FILE, FILE ALL THE CUT EDGES TO REMOVE ANY BURS.

- USING THE SMALL PAINT BRUSH AND RUST PROOF PAINT, RUST PROOF ALONG THE CUT EDGES TO PROTECT FROM RUSTING.

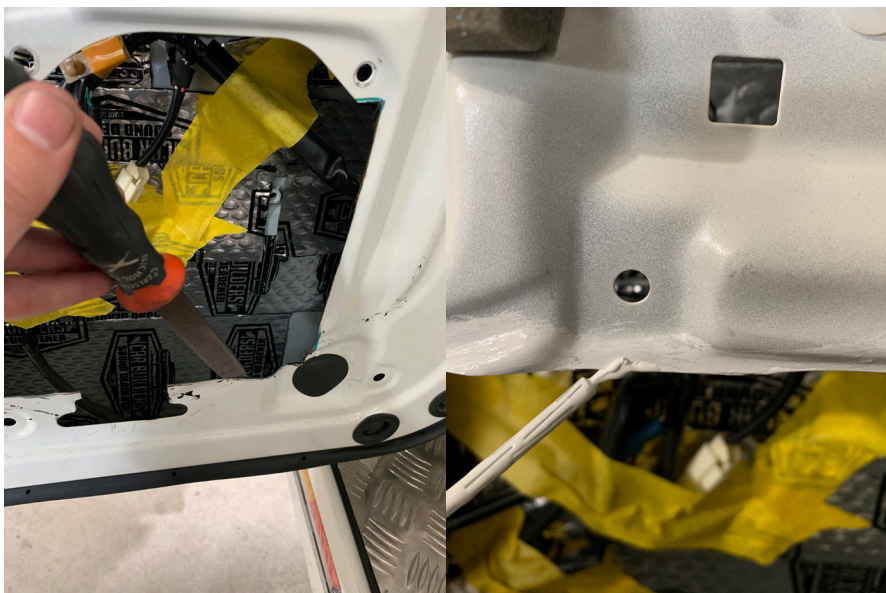

STEP 07:

ALIGN THE OTA LH REAR DOOR TABLE TO THE FITTING LOCATION AND MARK OR NOTE WHICH OE HOLES WILL HAVE A RIVNUT INSERTED INTO.

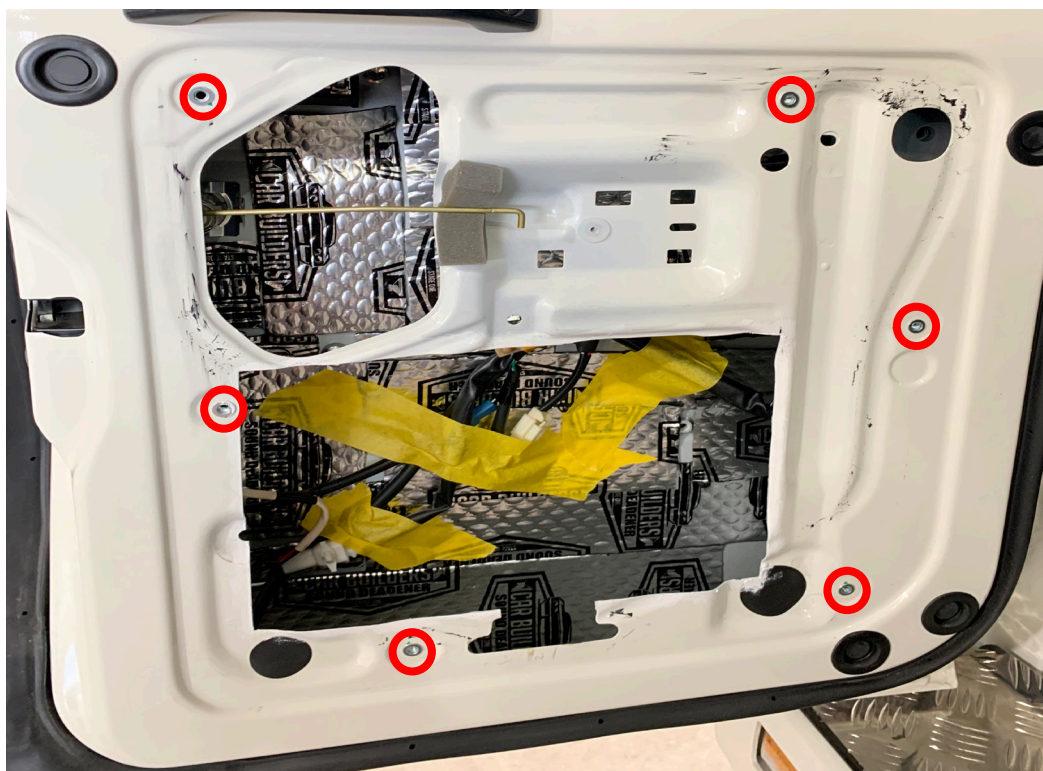

STEP 08:

USING A RIVNUT GUN OR DRILL ATTACHMENT, INSTALL ALL 6X M5 RIVNUTS INTO THE HOLES THAT HAVE BEEN DRILLED, ENSURING THEY ARE FIXED OFF SQUARE TO THE MOUNTING FACE.



STEP 09:

ONCE THE PAINT HAS DRIED, INSERT/FIT THE TABLE INTO PLACE BUT DO NOT YET SECURE IT WITH BOLTS. GET THE DOOR HANDLE AND INSERT INTO CUT-OUT OF THE TABLE (KEEP THE TOP END OF THE TABLE KICKED OUT SLIGHTLY. PUT THE ROD INTO THE REQUIRED SPOT ON THE DOOR HANDLE AND FIT THE GREEN CLIP TO THE ROD.

ONCE CLIP IN PLACE, LOCATE THE HANDLE INTO THE DOOR AND PUSH TO THE LEFT TO SECURE IN PLACE, THEN REFIX THE OE SCREW THAT WAS REMOVED AT THE BEGINNING



STEP 10:

WITH THE DOOR HANDLE BACK IN PLACE - ALIGN THE OTA LH REAR DOOR TO THE MOUNTING HOLES AND BEGIN INSERTING ALL THE SUPPLIED BOLTS USING THE 4MM ALLEN KEY. YOUR NEW OTA TABLE WILL NOW BE INSTALLED AND READY TO GO!

IT IS RECOMMENDED TO LIGHTLY SECURE EACH BOLT UNTIL THEY ARE ALL IN PLACE BEFORE COMPLETELY TIGHTENING.



FRONT FACE



CUT OUT FOLLOWING LINES

275.00

180

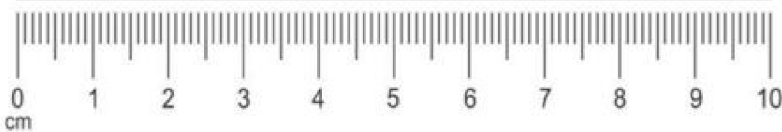

165.00

BOTTOM LEFT



LINE UP USING GUIDE LINE

CUT OUT FOLLOWING LINES

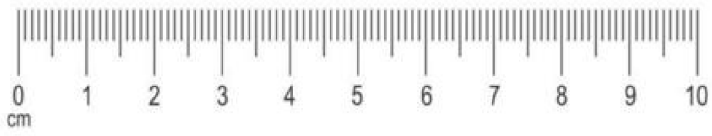

BOTTOM RIGHT

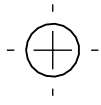

TOP RIGHT

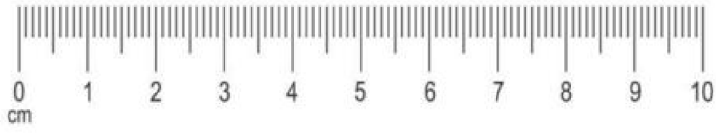

CUT OUT FOLLOWING LINES

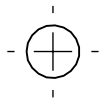

TOP LEFT

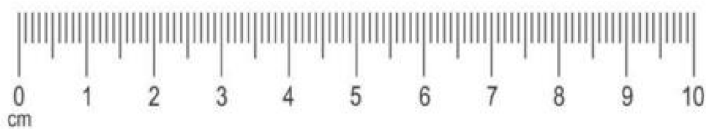

FRONT FACE



CUT OUT FOLLOWING LINES

5.00

180