

V810A and V810AD by ATEL

User Guide

4G LTE Cat-4 Fixed Wireless Access Router



Models Covered:

Model	LTE Bands
V810A	B2/4/5/12/13/14/66/71
V810AD	B2/4/5/12/13/14/66/71

User Guide in Spanish available on the ATEL product page at www.ATEL-USA.com.

Guía del usuario en español disponible en la página del producto ATEL en www.ATEL-USA.com.

Contents

1. Overview.....	3
LTE Network Bands per Model	3
System Requirements.....	3
Components and Indicators.....	3
Power Management.....	4
2. Getting Started.....	5
Install SIM Card	5
Install the NiMH Battery Pack.....	5
Backup Battery Tips	6
Installing the Optional Antennas (May be Sold Separately).....	6
Turning your V810 On/Off.....	7
Connect your Computer to the V810	8
Connecting to your V810 Hotspot Wi-Fi	8
3. Accessing Your V810 Direct Connect (WebGUI) Device Management Portal	9
Direct Connect (WebGUI) Portal Home Page.....	10
Connected Devices.....	11
Data Usage.....	12
Messages.....	12
Settings.....	13
Wi-Fi Settings	13
LAN Settings.....	14
Device Settings.....	16
Advanced.....	17
Mobile Network	18
Firewall Settings	19
VPN.....	25
Content Control.....	25
About	26
Logs	26
Backup and Restore.....	27
Remote Update	28
4. ATRACS Cloud Remote Management	29
5. Troubleshooting.....	29
7. Regulatory Statements	33
8. Safety Hazards	34
Limited Warranty:.....	35

1. Overview

LTE Network Bands per Model

Model	LTE Bands
V810A	B2/4/5/12/13/14/66/71
V810AD	B2/4/5/12/13/14/66/71

Note: Your device model number can be found on the device label.

System Requirements

The V810A/V810AD provides data service. Connect to the internet using the V810A/V810AD Hotspot Wi-Fi function or Ethernet port connection. You must subscribe to an eligible service plan with a wireless operator to use the V810A/V810AD data functions.

Components and Indicators

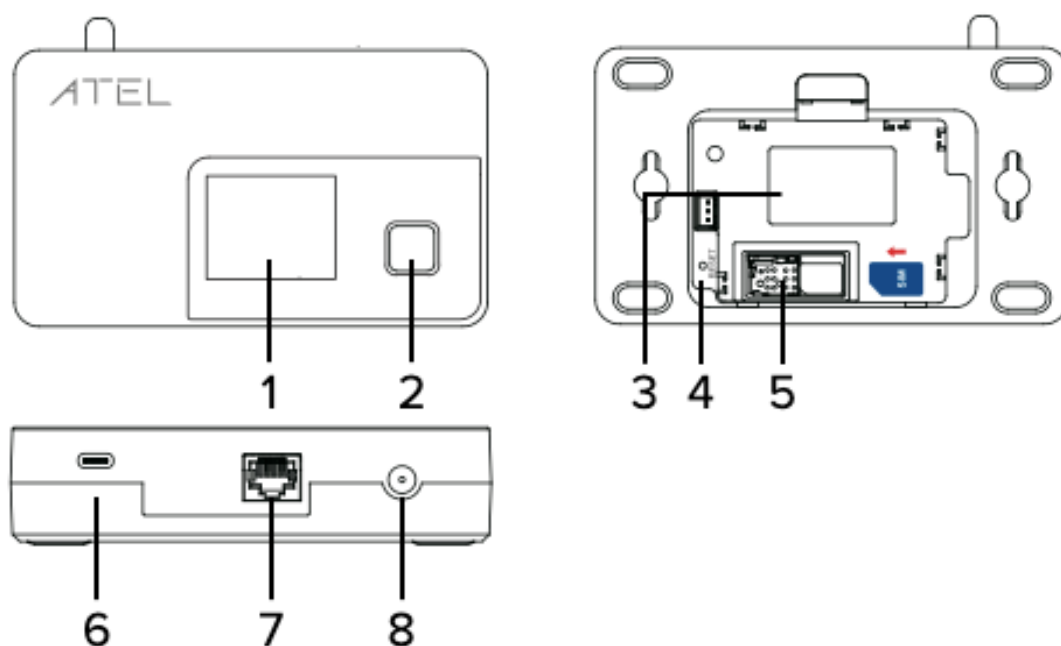

1. LCD Display

Displays various menus with V810A/V810AD information such as Home, IMEI, Wi-Fi login information (SSID and password), and Online Portal login information.

2. Power Button

Power the V810A/V810AD on/off by pressing and holding this button (note that a long press will boot up the device). You can also short press this button to wake up the display screen and check device information.

3. Battery Port

This battery port is used to connect to the Ni-MH rechargeable battery pack (battery pack may be sold separately).

4. Reset Button

Use a pin to press and hold this button for factory reset.

5. SIM Card Slot

Insert your 4FF SIM card into this spring-loaded SIM card slot. To remove a SIM, press the edge of the SIM inward and the SIM will pop outward from the slot.

6. Type C Port

Insert your USB cable to this USB-C port and plug the other end into a wall adapter for external power.

7. Ethernet Port (RJ45)

Insert an ethernet cable to this Port and plug the other end to your computer for internet access.

8. Antenna Connector





Install an optional antenna (may be sold separately) here to increase signal strength.

Power Management

Your V810A/V810AD comes with an AC wall adapter (a Ni-MH rechargeable battery pack is optional and can be purchased separately through ATEL USA, if it is not included with your device). For more information, visit www.ATEL-USA.com.

During a power outage or if the wall charger is unplugged, the V810A/V810AD continues to run off the batteries to support Ethernet functions. Note that the Hotspot Wi-Fi function will only be available if using the wall adapter or Ni-MH rechargeable battery pack.

Refer to the table below for the V810A/V810AD functions supported in different power modes.

V810	Functions Supported in Different Power Scenarios			Data Model		
Scenario	Wall Adapter	Ni-MH Battery Pack (May be Sold Separately)	Icon Display	Internet Port (Ethernet Cable)	WiFi Hotspot	Notes
1	Device connected to Wall Adapter	Batteries Installed	 *Battery Full  *Battery Charging	✓	✓	
2	Device connected to Wall Adapter	No Battery Installed		✓	✓	
3	Device NOT connected to Wall Adapter	Batteries Installed		✓	✓	WiFi Hotspot function is ONLY available when plugged into the wall adapter or with the NiMH battery.
4	Device NOT connected to Wall Adapter	No Battery Installed	No Display	✗	✗	Device has no power. Connect to a wall adapter for use.

2. Getting Started

Install SIM Card

1. Remove the V810A/V810AD back cover.
2. Install the SIM card into the spring-loaded SIM slot as the image shows. To remove a SIM, press the edge of the SIM inward and the SIM will pop outward from the slot.

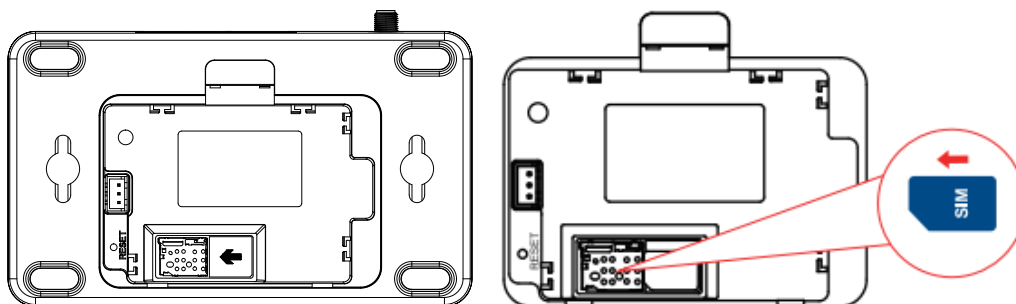

Install the NiMH Battery Pack

1. Remove the battery cover.
2. Properly align and install the NiMH battery (with three pin sockets). Make sure to align the pin sockets correctly.
3. Put the NiMH battery in place as shown below.

4. Replace the back cover of the V810A/V810AD and make sure it's aligned with the bottom of the device.

NOTE: The NiMH battery pack may be sold separately.

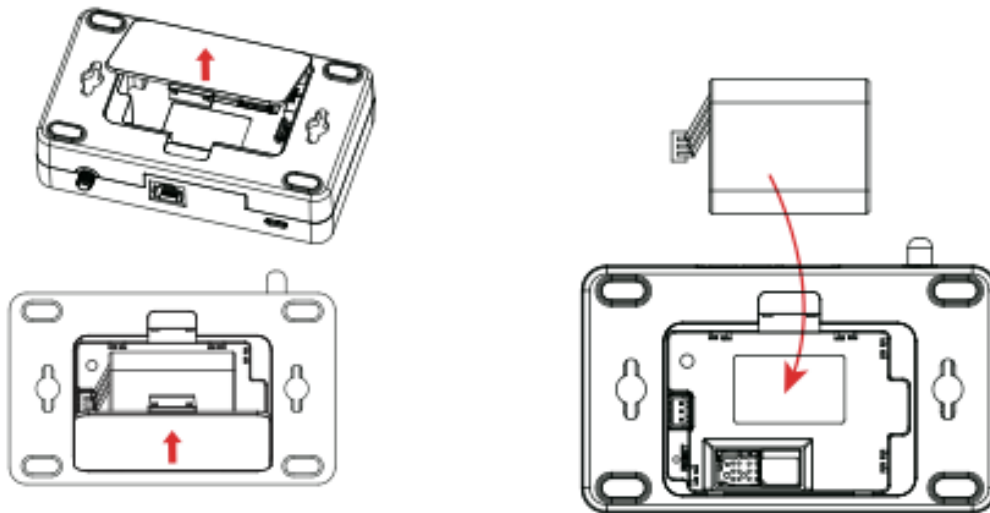

Backup Battery Tips

Battery usage and standby time depends on the network, signal strength, temperature, features, battery age and accessories you use. Generally, usage time on the NiMH battery pack is approximately (up to) 5 hours and standby time is up to 8 hours.

In battery-only mode, you can check the battery level by pressing the Power Key. The battery level will be in the upper right corner of the screen.

Do not use sharp objects or excessive force to remove the battery, as this may damage the V810A/V810AD and/or the batteries and will void any warranties.

Never expose batteries to temperatures below -20°C (4°F) or above 60°C (140°F).

Installing the Optional Antennas (May be Sold Separately)

To increase signal strength, you can install an optional antenna.

1. Align the antenna with the antenna port and screw securely into place (in a clockwise direction).
2. Restart the V810A/V810AD after the antenna is installed or removed.

Using optional accessories (antenna and battery pack) by ATEL is recommended to achieve optimal performance, more information can be found on ATEL's website, <https://www.atel-usa.com/>.

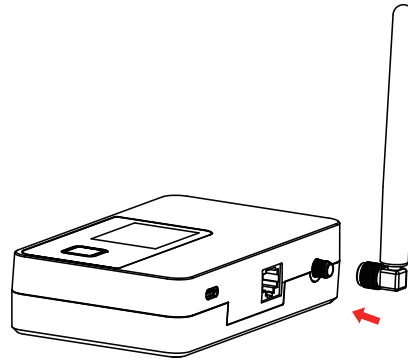

Turning your V810A/V810AD On/Off

1. Connect your V810A/V810AD to a wall adapter with a USB-C cable and plug the wall adapter to the wall outlet. The V810A/V810AD will power on automatically.

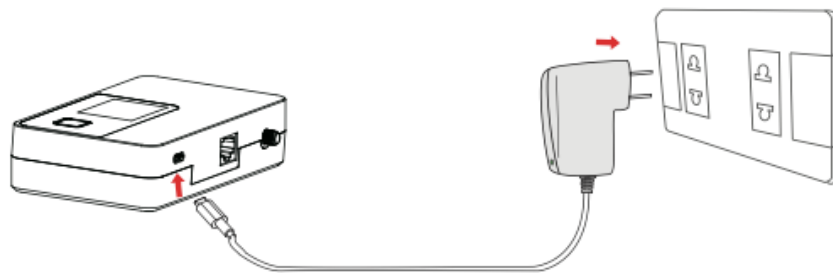





2. When the V810A/V810AD is on battery only, turn your V810A/V810AD on by pressing and holding the Power Button.
3. When the V810A/V810AD is on battery only, turn it off by pressing and holding the Power Button until you see the display screen turn off.
4. When the V810A/V810AD is powered by the wall adapter, press and hold the Power Button to reboot the device.

WARNING! Please only use an approved USB adapter for the V810A/V810AD. The use of other incompatible adapters may cause damage to your device and void the warranty.

V810A/V810AD LCD Display

On your V810A/V810AD LCD Display, you may see one or more of the following icons:

	Icon	Definition
Network Signal		Indicates the signal strength of your wireless provider in your location. More bars represent a stronger signal.
WiFi		WiFi available for connection.
Battery		Battery Level (Applies to NiMH Battery Only)
		Battery Charging (Applies to NiMH Battery Only)
Power Key		Press the Power Key to switch menu screens.

Connect your Computer to the V810A/V810AD

The V810A/V810AD is equipped with 1 Ethernet port (RJ45). For internet access via Ethernet, plug an ethernet cable to the Ethernet port of your V810A/V810AD and connect it to the Ethernet port of your computer. You can connect your PC with the V810A/V810AD using Wi-Fi for a wireless connection.

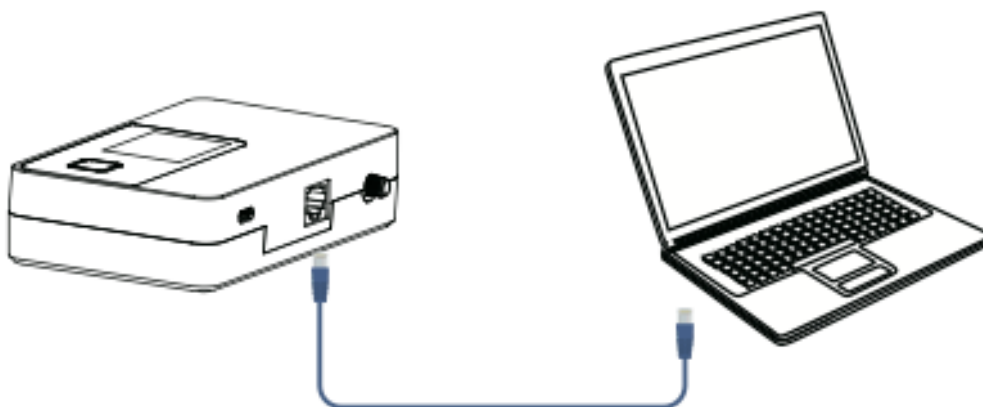

Connecting to your V810A/V810AD Hotspot Wi-Fi

Your V810A/V810AD Hotspot Wi-Fi function supports up to 15 Wi-Fi connected devices. To connect to the Hotspot Wi-Fi,

1. Locate your Wi-Fi Network Name (SSID) / Password on your V810A/V810AD LCD Display or on the device label under the battery holder.
2. Open the Wi-Fi settings of your Wi-Fi capable devices.
3. Select the SSID of your V810A/V810AD from the available Wi-Fi network list.
4. When prompted, enter the password of your V810A/V810AD.
5. Once the connection is established, you are connected to the Internet.

3. Accessing Your V810 Direct Connect (WebGUI) Device Management Portal

The Direct Connect Device Management Portal is a web-based interface that interacts directly with your V810. You can login to the Portal to view device status, change device settings, or perform a manual software upgrade.

To access the Direct Connect Portal:

1. First connect your computer to the V810 Hotspot Wi-Fi and then enter <http://192.168.0.1> in the browser URL address bar. Note that you can also connect your V810 to a computer with a USB-C or ethernet (RJ45) cable to access the Direct Connect Portal.
2. The Direct Connect Portal login username is “admin”. The unique password can be found in the LCD Display menu or on the device label (under the battery holder).

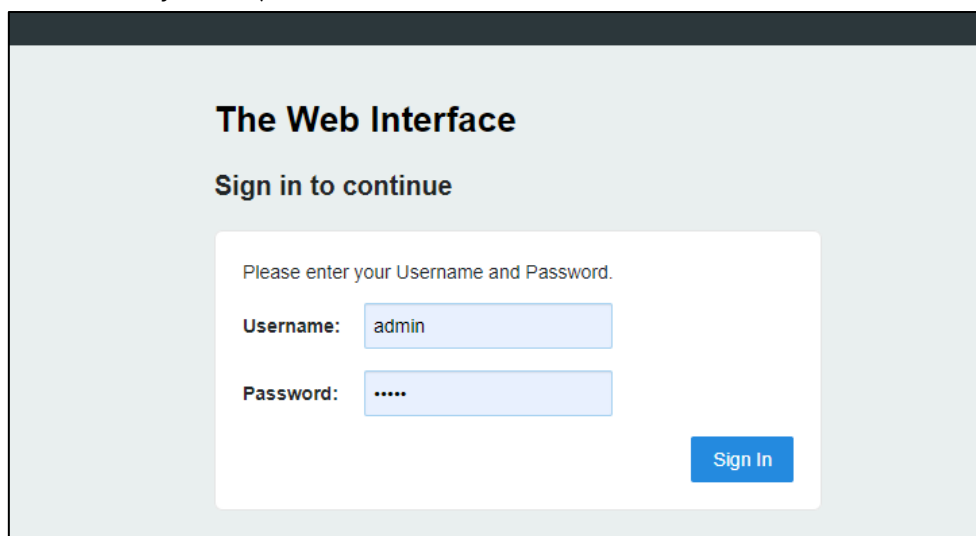

The images below show the device label, LCD screen display, and Direct Connect (WebGUI) Portal access for your V810. Pictures are for illustration purposes only. Information varies based on your model and specific device.

Device Display



Device Label



Direct Connect Portal Home Page

After successful login, you will see the Home Page displaying information about your V810, e.g. device IMEI and network status, along with a list of menu options on the left column.

- HOME
- CONNECTED DEVICES
- DATA USAGE
- MESSAGES
- SETTINGS
- ADVANCED
- CONTENT CONTROLS
- ABOUT

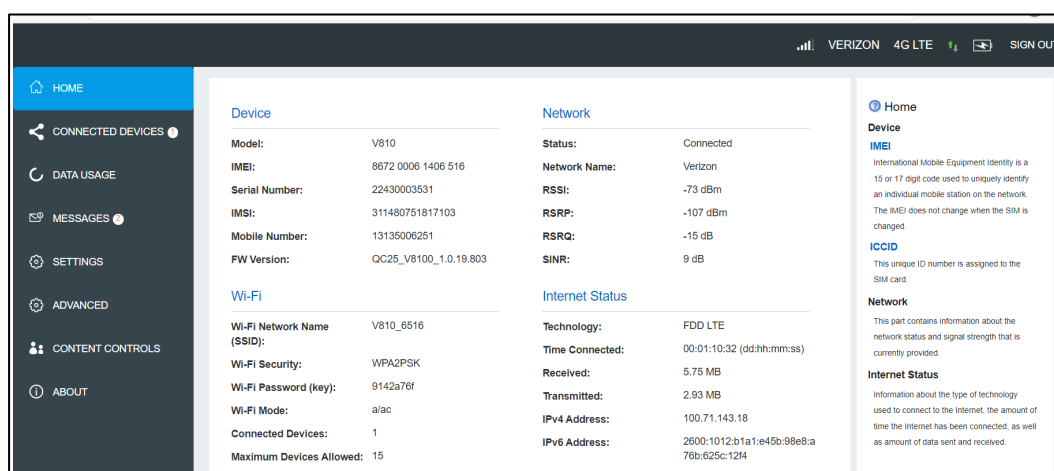

Changing your Direct Connect Portal Password:

You can create your own Direct Connect (WebGUI) Portal password in the Settings page. Once created, you will be required to use the new password to sign in.

To Change your Direct Connect Portal Password:

1. Connect your device using the instructions for logging into the Direct Connect Portal, in the beginning of this Section 3.
2. Open a web browser and enter <http://192.168.0.1> into the URL address bar.
3. Go to Settings > Device Settings > Admin Password. Input your current admin password and setup your new password by following the prompts, then save the changes.

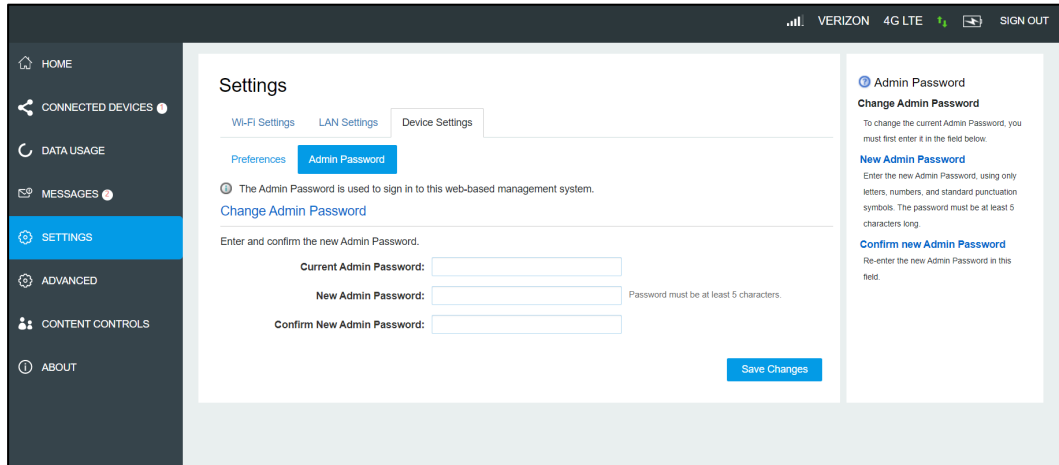

Connected Devices

On this page, you can view Connected Devices, Blocked Devices and the Change Max Wi-Fi Connections.

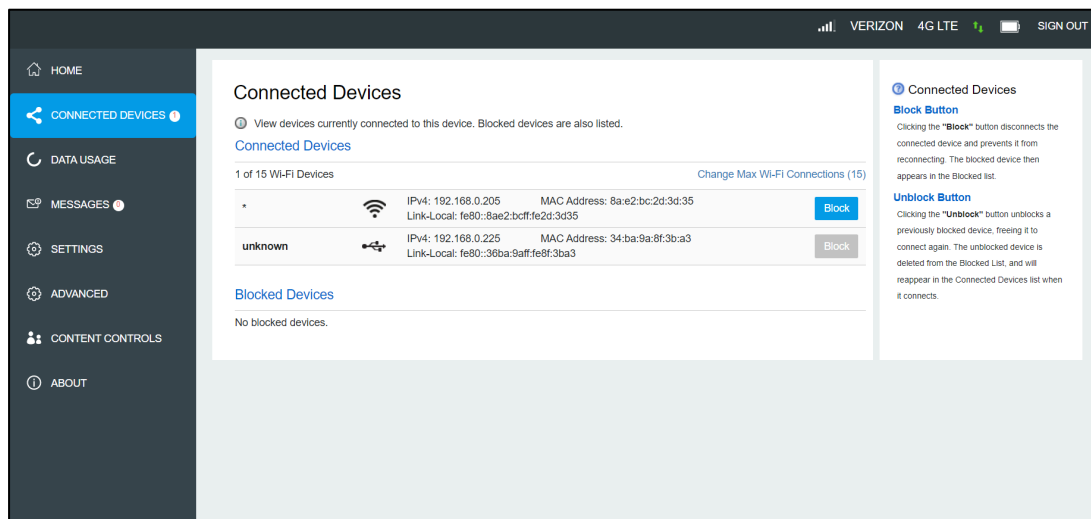

- **Connected Devices:** This field lists the clients that are connected to your V810.
- **Change Max Connections:** The default max connection is 15. Click this button and it will take you to the Wi-Fi Settings where you can change the Max Wi-Fi Connections. To block a device, select the desired device and click the Block button. The Wi-Fi connection to the blocked device will be disconnected and the blocked device will appear in the Blocked Devices list.
- **Blocked Devices:** Displays the devices that are blocked. Choose a blocked device and click the Unblock button; the selected device will disappear from the “Blocked Devices” list. It will show in the “Connected Devices” list again after it connects to your V810.

Data Usage

This page shows the estimated data usage (which may not match your bill). Check with your service provider for billable usage. If desired, choose Day of Month, Usage Limit and click Save Changes to save your settings.

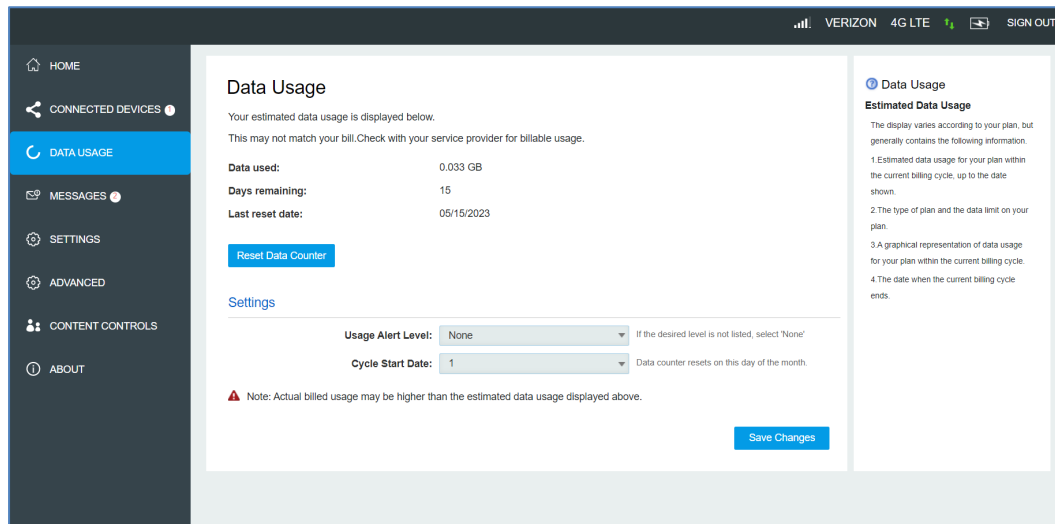

Messages

The messages page displays SMS messages sent to you by your wireless carrier.

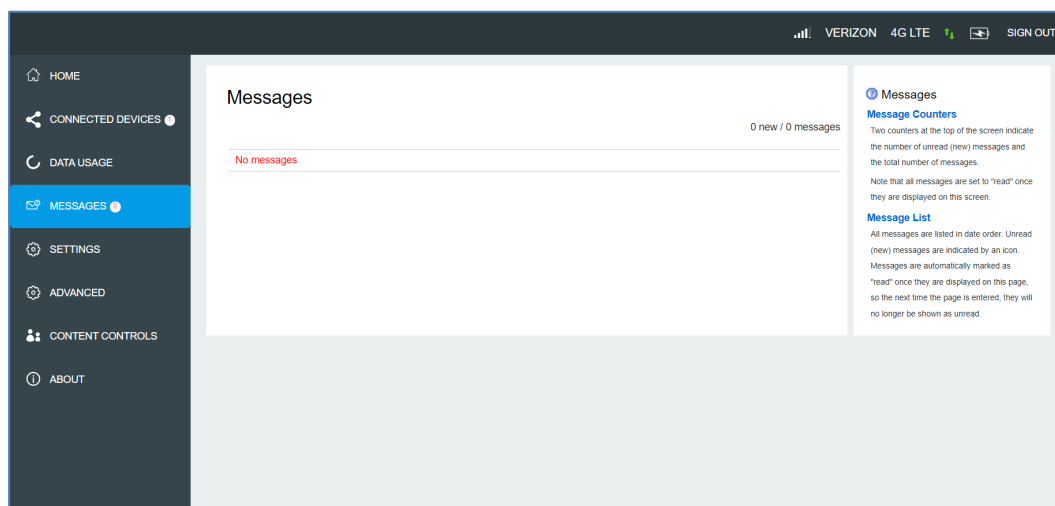

The number of unread messages displays to the right of the message icon. When a new message arrives, the message icon appears. A maximum of 30 messages can be stored.

To view a message, select a message from the Messages menu. To delete a message, select the message and click the trash bin icon to the right of the message date and time. To delete all messages, click the Delete All Messages button.

Settings

The Settings page has the following menu options:

- Wi-Fi Settings
- LAN Settings
- Device Settings

Wi-Fi Settings

These settings apply whenever the Wi-Fi is turned on. Changes made to these Wi-Fi settings may require you to reconnect your Wi-Fi devices for the new settings to come into effect.

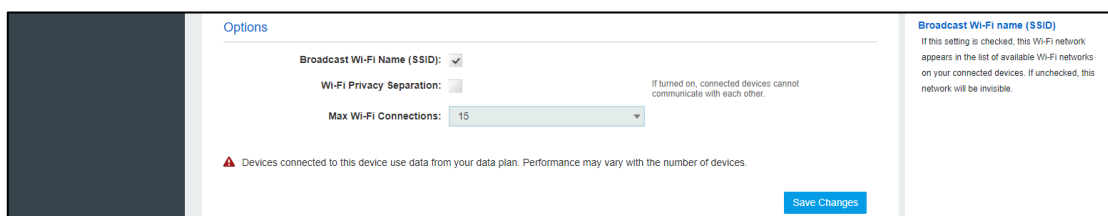
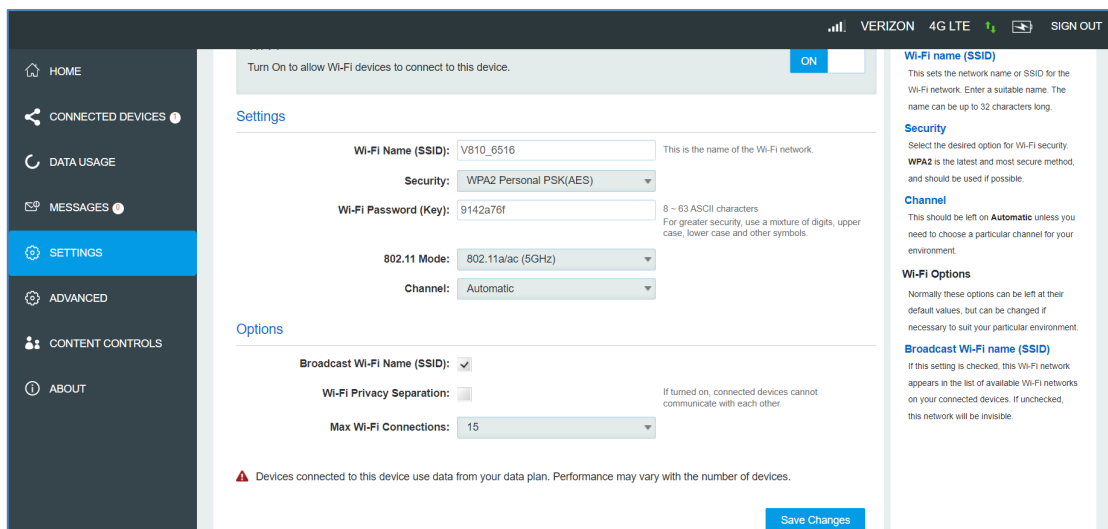

- **Wi-Fi On/Off:**

Turn on to allow Wi-Fi devices to connect to this device. Wi-Fi devices will not connect to this device if it is turned off.

- **Wi-Fi Name (SSID):**

To identify your wireless network, the SSID (Service Set Identifier) is used. You can set a name with a max of 32 characters. Make sure that your SSID is unique if there are other wireless networks operating in your area.

- **Security:**

You can set wireless security and encryption to prevent the router from unauthorized access and monitoring. The default security is WPA Personal/PSK. You can also set Security as “None”, “WPA Personal/PSK”, “WPA2 Personal/PSK(AES)”, or “WPA/WPA2 Mixed Mode”.

- **802.11 Mode**

The default is 802.11a/ac (5GHz).

You can also set it as 802.11/b/g/n (2.4GHz).

Note: Some old Wi-Fi devices (TVs, gaming machines or other devices may only have 2.4G Wi-Fi. Changing the 802.11 Mode to 2.4G can help those devices find the Wi-Fi.

- **Channel:**

The default “Channel” is “Automatic”. You can set it from channel 1 to channel 11.

- **Wi-Fi Options:**

Wi-Fi Options include Broadcast Wi-Fi name (SSID), Wi-Fi Privacy Separation, and Max Wi-Fi Connections.

- **Broadcast Wi-Fi Name (SSID):**

The wireless device can search and connect to the SSID after turning on “Broadcast Wi-Fi name (SSID)”. The wireless client must input the SSID manually to connect to the SSID after turning off “Broadcast Wi-Fi name (SSID)”.

- **Wi-Fi Privacy Separation:**

If turned on, connected devices cannot communicate with each other.

- **Maximum Wi-Fi Connections:**

The default maximum number of Wi-Fi connections is 15. You can set it to any number between 1 and 15.

LAN Settings

From the Direct Connect Portal, click Settings > LAN Settings to display the information shown in the following figure.

Settings

Wi-Fi Settings
LAN Settings
Device Settings

ⓘ Note that connected devices will be disconnected and connected to acquire new address once IP address is updated.

IPv4

IP Address:

Subnet Mask:

MAC Address: 34:BA:98:12:34:70

DHCP Lease Time: minutes.

Start DHCP Address Range at:

DHCP Address Range: 192.168.0.2 - 192.168.0.254

Reserved IP Addresses

Save Changes

- **IP Address:**
Enter the IP address of your V810 online management portal (factory default: 192.168.0.1).

- **Subnet Mask:**
An address code that determines the size of the network. Generally, use 255.255.255.0 as the subnet mask.

- **MAC Address:**
It is written to the device at the time of manufacture.

- **DHCP Lease Time:**
The Lease Time is the amount of time a network user will be allowed connection to the router with their current dynamic IP address. Enter the amount of time in minutes and the user will be "leased" this dynamic IP address. After the time is up, the user will be assigned a new dynamic IP address automatically.

- **Start DHCP Address Range at:**
Specify an IP address for the DHCP server to start with when assigning IP addresses. The default start address is 192.168.0.2.

- **Reserve IP Address:**
You can reserve an IP address so that it is always assigned to the same connected device. Every reserved IP address must be within the range of IP addresses used by DHCP.

Device Settings

Device Preferences

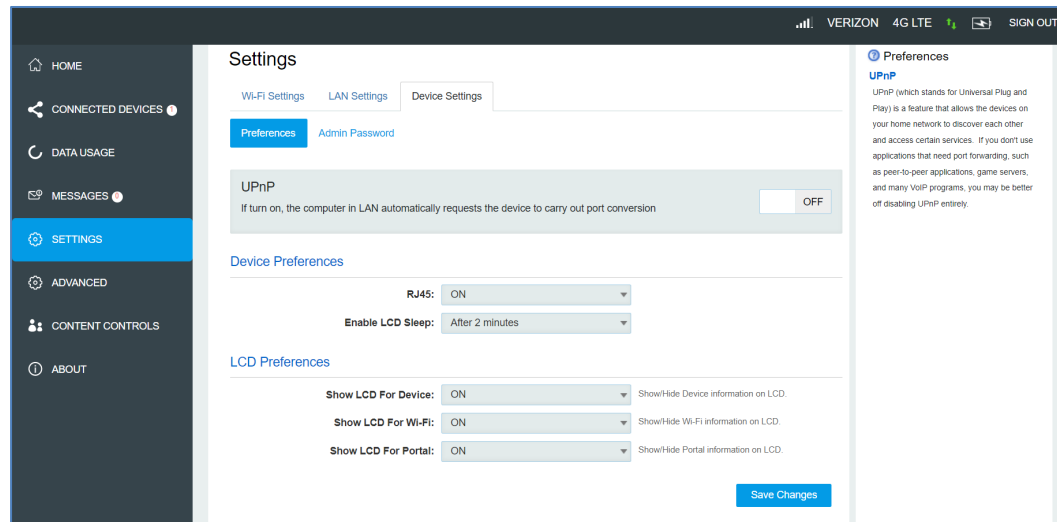

- **UPnP (Universal Plug and Play):**

UPnP (which stands for Universal Plug and Play) is a feature that allows the devices on your home network to discover each other and access certain services. If you don't use applications that need port forwarding, such as peer-to-peer applications, game servers, and many VoIP programs, you may be better off disabling UPnP entirely.

- **RJ45**

You can turn the Ethernet port on/off using this toggle. By default, it is on.

- **Enable LCD Sleep**

Set the automatic sleep time of the LCD Display. The default is "After 30 seconds", you can set it to 15 seconds, 2 minutes, or never turn off the Display.

- **Show LCD For Device**

You can turn the device information page (including IMEI, SW and HW information) on/off on the LCD Display using this toggle. By default, it is on.

- **Show LCD For Wi-Fi**

You can turn the device Wi-Fi information on/off on the LCD Display using this toggle. By default, it is on.

- **Show LCD For Portal**

You can turn the Direct Connect portal access information on/off on the LCD Display using this toggle. By default, it is on.

Note: If your device is registered to the ATEL remote management cloud platform, ATRACS, for remote management, you will see the message below in the Device Settings page. Click 'Unbind' to remove that registration from ATRACS.

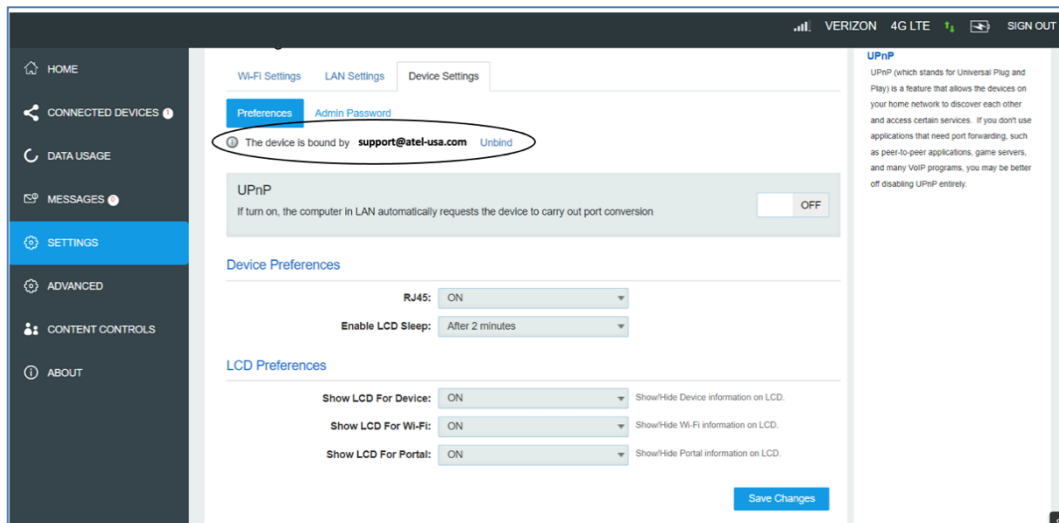

Admin Password

Admin Password:

The Admin Password is used to sign into this Direct Connect (WebGUI) Portal. To change the password, you must enter the current Admin Password. You will be locked out if an incorrect password is used 5 times. If locked out, you will need to restart your V810 and enter the Direct Connect Portal again.

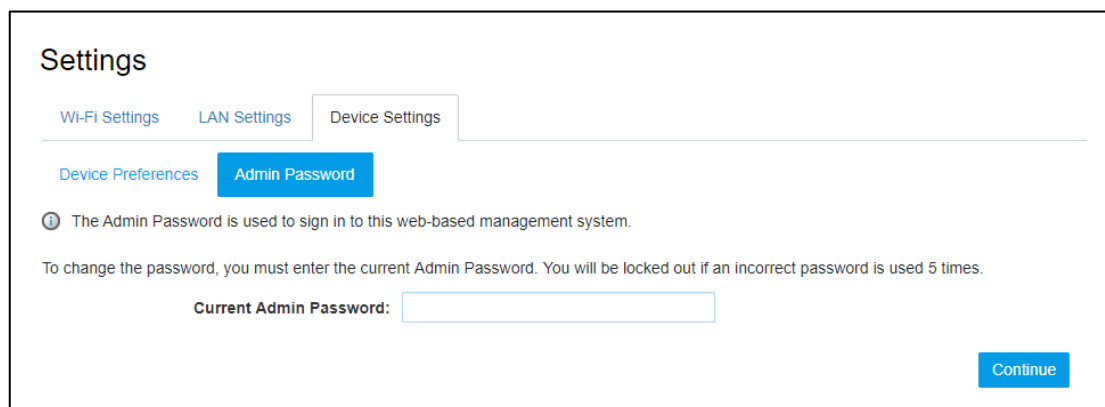

Advanced

On this page, you can view Mobile Network Settings, Firewall Settings and VPN settings.

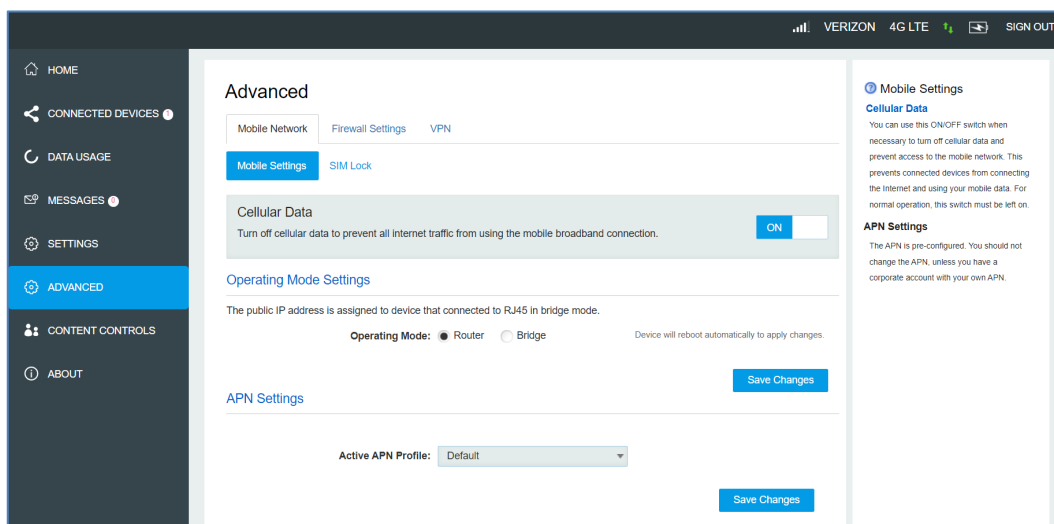

Mobile Network

Cellular Data

On this page, you can turn Cellular Data on/off.

Operating Mode Settings

If you want to set up IPPT (IP Passthrough), you can set up the Operating Mode as 'Bridge'. The public IP address will be assigned to the device connected to the Ethernet port.

APN Settings

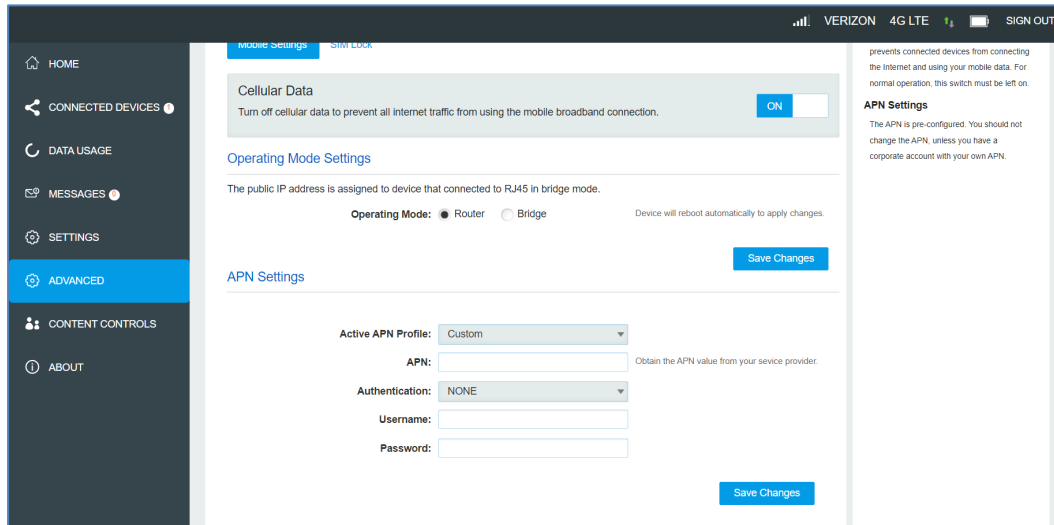

You can choose to either use the default APN or your own customized APN.

Firewall Settings

On this page, you will find four menus: Firewall, MAC Filter, Port Filtering and Port Forwarding.

Firewall

This page contains Firewall-related settings:

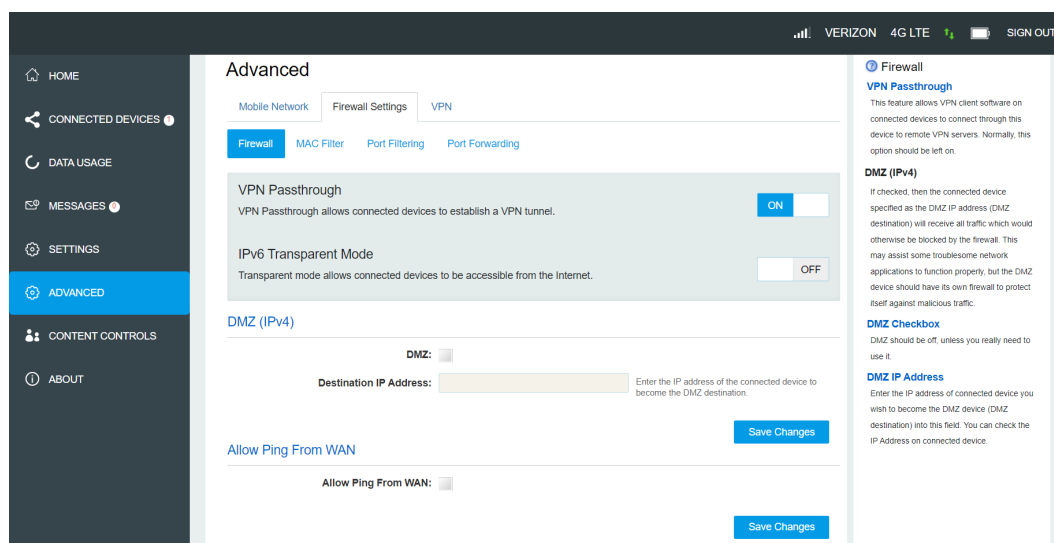

- **VPN Passthrough**

After being turned on, VPN Passthrough allows connected devices to establish a VPN tunnel.

- **IPv6 Transparent Mode**

Transparent mode allows connected devices to be accessible from the Internet.

- **DMZ (Ipv4)**

Enter the IP address of the connected device in the Destination IP address input field for it to become the DMZ destination. After enabling the DMZ feature, all the applications of the connected device will be visited.

- **Allow Ping From WAN**

You can configure the device to “Allow Ping From WAN” and set up a white IP address list. Note: Even if the device is configured as “Allow Ping From WAN”, you may not be able to ping the device due to network policy of the mobile carriers.

DMZ (IPv4)

DMZ:

Destination IP Address: Enter the IP address of the connected device to become the DMZ destination.

[Save Changes](#)

Allow Ping From WAN

Allow Ping From WAN:

Allow Ping White List:

IP Address:

IP Address:

IP Address:

IP Address:

IP Address:

[Save Changes](#)

DMZ Checkbox

DMZ should be off, unless you really need to use it.

DMZ IP Address

Enter the IP address of connected device you wish to become the DMZ device (DMZ destination) into this field. You can check the IP Address on connected device.

MAC Filter

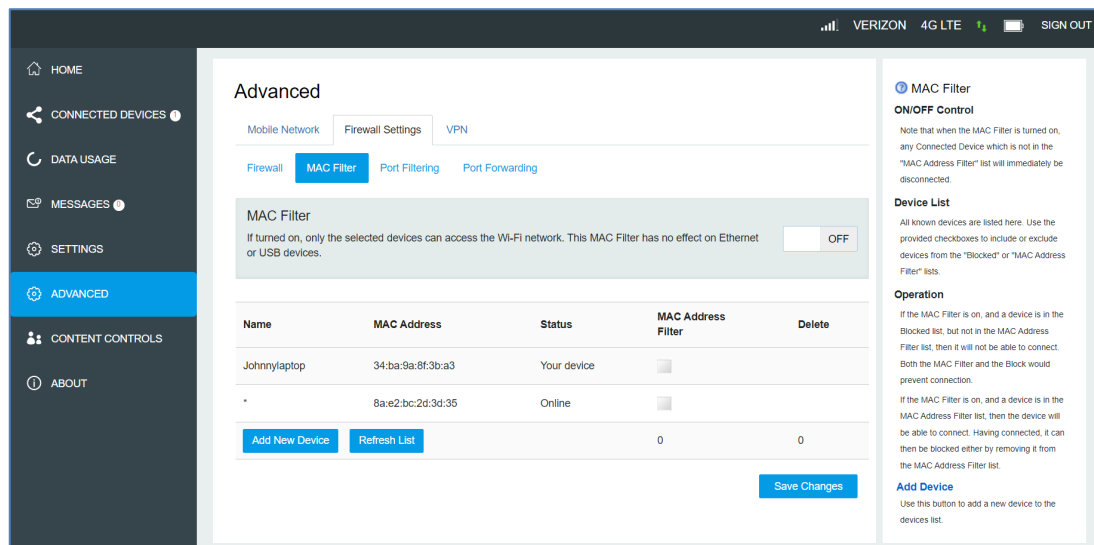

The default “MAC Filter” status is “OFF”. If the MAC Filter is on and devices are listed in the MAC Address Filter list, then all the listed devices will be able to connect to your V810. For any given device, the interaction of the MAC Filter with the “Block” feature on the Connected Devices screen is shown in the following table.

Included in Block List	Included in MAC Filter List	Connection
No	Yes	Allowed
No	No	Not allowed
Yes	Yes	Not allowed
Yes	No	Not allowed

The “Block” (Blacklist) feature is always available. After being blocked, the blocked devices will disconnect from the V810.

Name	MAC Address	Status	MAC Address Filter	Delete
ttluiu-pc	7c:dd:90:1e:fe:ff	Your device	<input type="checkbox"/>	
			0	0
			Save Changes	

Because enabling the MAC Filter could potentially disconnect all devices, the user needs to populate the “MAC Address Filter” list first while the MAC Filter is OFF. Otherwise, when you click the “ON/OFF” button, it will prompt warning information as follows:

MAC Filter cannot be turned on while no devices are allowed to connect.

After changing the “MAC Filter” to “ON”, only the local “MAC Address Filter” listed devices can connect to the V810, other devices will disconnect from the V810.

MAC Filter
If turned on, only the selected devices can access the Wi-Fi network. This MAC Filter has no effect on Ethernet or USB devices. ON

Name	MAC Address	Status	MAC Address Filter	Delete
ttliu-pc	7c:dd:90:1e:fe:ff	Your device	<input checked="" type="checkbox"/>	
<input type="button" value="Add New Device"/> <input type="button" value="Refresh List"/>			1	0
				<input type="button" value="Save Changes"/>

You can click the “Add Device” button to add devices. The added devices can then connect to the V810.

Name	MAC Address	Status	MAC Address Filter	Delete
ttliu-pc	7c:dd:90:1e:fe:ff	Your device	<input checked="" type="checkbox"/>	
<input style="width: 100%;" type="text"/>	<input style="width: 100%;" type="text"/>		<input type="checkbox"/>	<input type="checkbox"/>
<input type="button" value="Add New Device"/> <input type="button" value="Refresh List"/>			1	0
				<input type="button" value="Save Changes"/>

Port Filtering

The screenshot displays the 'Port Filtering' configuration page. At the top, there are navigation tabs: 'Firewall', 'MAC Filter', 'Port Filtering' (selected), and 'Port Forwarding'. The main content area is titled 'Port Filtering' and contains a toggle switch set to 'OFF'. Below this, there are two main sections: 'Applications' and 'Custom Applications'. The 'Applications' section lists five default applications: 'Email (POP3, IMAP, SMTP)', 'FTP', 'HTTP', 'HTTPS', and 'Telnet', each with an unchecked checkbox. The 'Custom Applications' section includes an 'Add a Custom Application' button and a 'Save Changes' button. A right-hand sidebar contains explanatory text and instructions for 'Custom Applications', 'Application Checkbox', 'App Name', 'Port Range (Start Port/End Port)', 'Protocol', and 'Delete'.

- **Applications**

The default applications are “Email (POP3, IMAP, SMTP)”, “FTP”, “HTTP”, “HTTPS” and “Telnet”. If port filtering is on, only traffic from selected applications can access the Internet. Note that DNS is always allowed.

- **Custom Applications**

Click “Add a Custom Application” to define your own applications, and then turn them on or off as needed. To define an application, you need to know the outgoing ports used by application.

Port Forwarding

Advanced

Mobile Network
Firewall Settings
VPN

Firewall
MAC Filter
Port Filtering
Port Forwarding

Port Forwarding

Port forwarding sends specific incoming traffic to a connected device. The connected device is specified using its IP address. OFF

On	Application	IP Address
<input type="checkbox"/>	DNS	<input type="text" value="0.0.0.0"/>
<input type="checkbox"/>	FTP	<input type="text" value="0.0.0.0"/>
<input type="checkbox"/>	HTTP/HTTPS	<input type="text" value="0.0.0.0"/>
<input type="checkbox"/>	NNTP	<input type="text" value="0.0.0.0"/>
<input type="checkbox"/>	POP3/POP3S	<input type="text" value="0.0.0.0"/>
<input type="checkbox"/>	SMTP/Secure SMTP	<input type="text" value="0.0.0.0"/>

<input type="checkbox"/>	SNMP	<input type="text" value="0.0.0.0"/>
<input type="checkbox"/>	Telnet	<input style="border: 1px solid #007bff;" type="text" value="0.0.0.0"/>
<input type="checkbox"/>	TFTP	<input type="text" value="0.0.0.0"/>

Custom Applications

You can define your own applications, and then turn them on or off as needed. To define an application, you need to know the incoming ports used by the application.

+ [Add a Custom Application](#)

Save Changes

- **Applications**

The default applications are “DNS”, “FTP”, “HTTP”, “NNTP”, “POP3”, “SMTP”, “SNMP”, “Telnet” and “TFTP”. Port forwarding sends specific incoming traffic to a connected device. The connected device is specified using an IP address.

- **Custom Application**

Click “Add a Custom Application” to define your own applications, and then turn them on or off as needed. To define an application, you need to know the incoming ports used by the application.

VPN

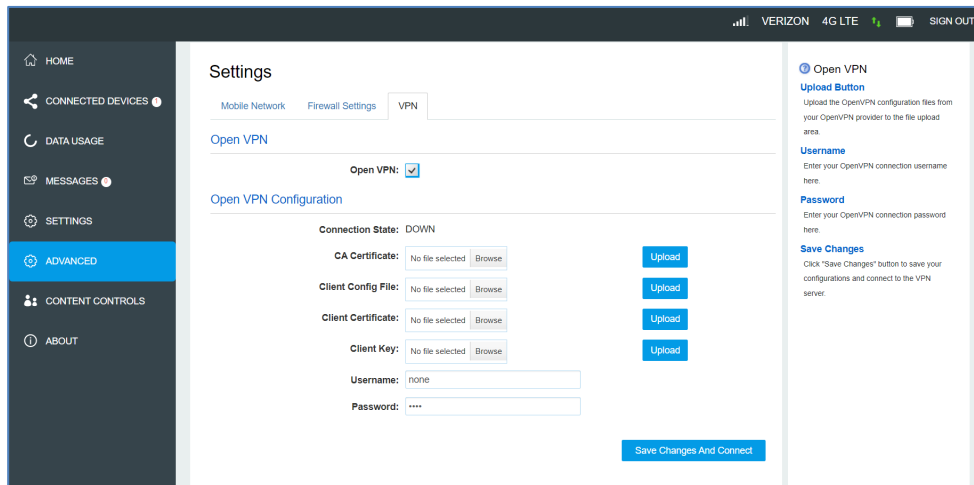

You can set up Open VPN on this page.

Content Control

On this page, you can control the content visited either by site or device.

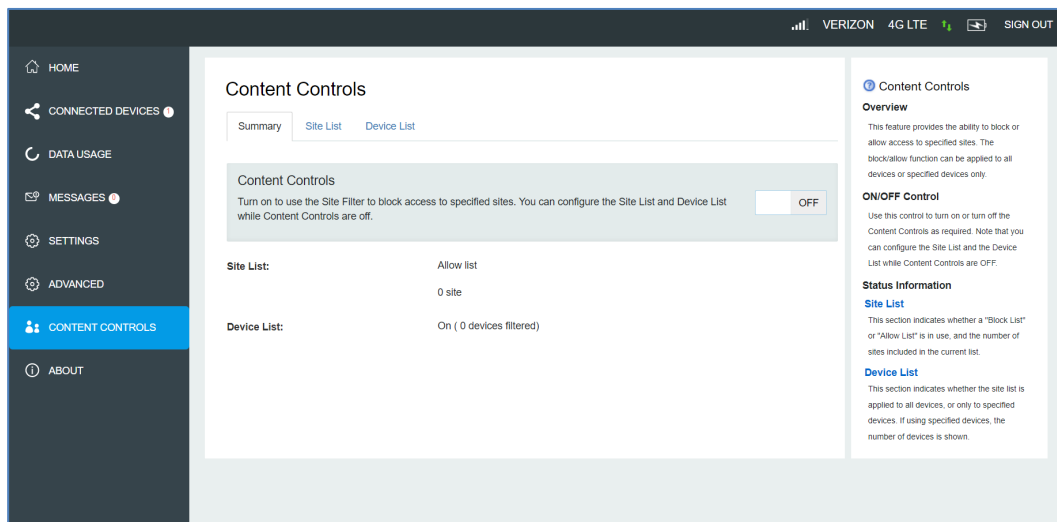

About

From the Online Portal Home screen, click the About tab to view the available information.

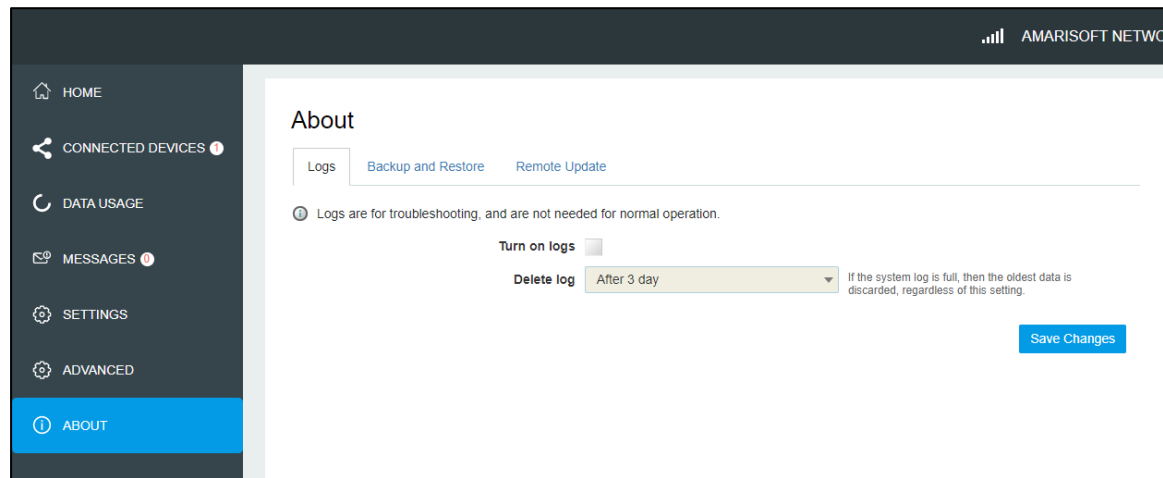

Logs

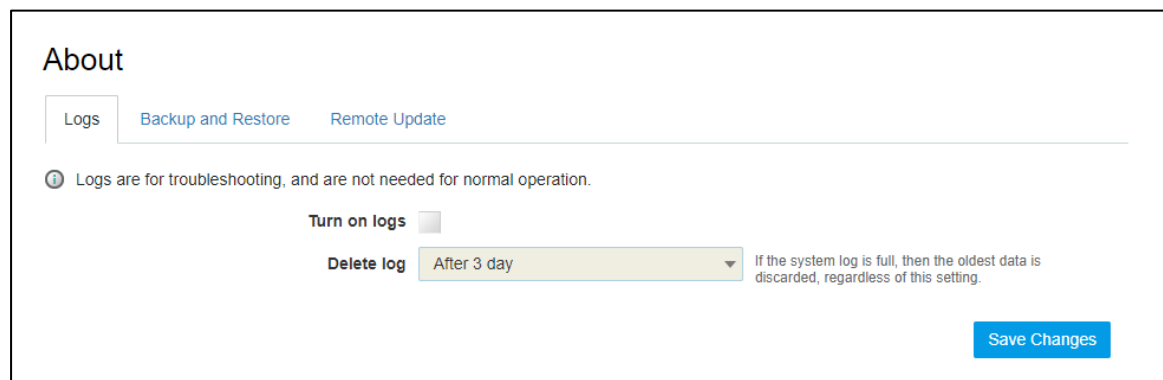

- **Turn on Logs**

Turn on the logs as needed.

- **Delete Log**

This setting determines for how long the log data is retained. Select the desired option.

Note that if the log is full, the oldest data is deleted, regardless of this setting.

- **Log**

This log contains data regarding connections to the mobile network.

- **Clear Log**

Clicking this button will delete all existing log data. This makes new data easier to read.

- **Refresh**

Use this to update the log data which is displayed.

Backup and Restore

On this page, you can operate Backup, Restore, Restore to Factory Defaults and Restart.

About

[Logs](#)
[Backup and Restore](#)
[Remote Update](#)

 Back up your settings and preferences to your computer. Please note that the backup file will only work with this particular device.

Backup

Save your settings to your computer.

Admin Password:

[Download](#)

Restore

Upload a previously saved backup file from this device to restore your settings.

Admin Password:

Select a file: [Browse](#)

[Restore Now](#)

Restore to Factory Defaults

Restore all settings to the factory default values.

[Restore Factory Defaults](#)

[Restart](#)

● Backup

Backup your V810 settings and preferences to your computer.

Note:

1. The backup file will only work with your specific V810.
2. You will be locked out if an incorrect password is used more than 5 times.

● Restore

Upload a previously saved backup file from this device to restore your settings.

Note:

You will be locked out if an incorrect password is used more than 5 times.

● Restore to Factory Defaults

Restore all settings to the factory default settings.

Remote Update

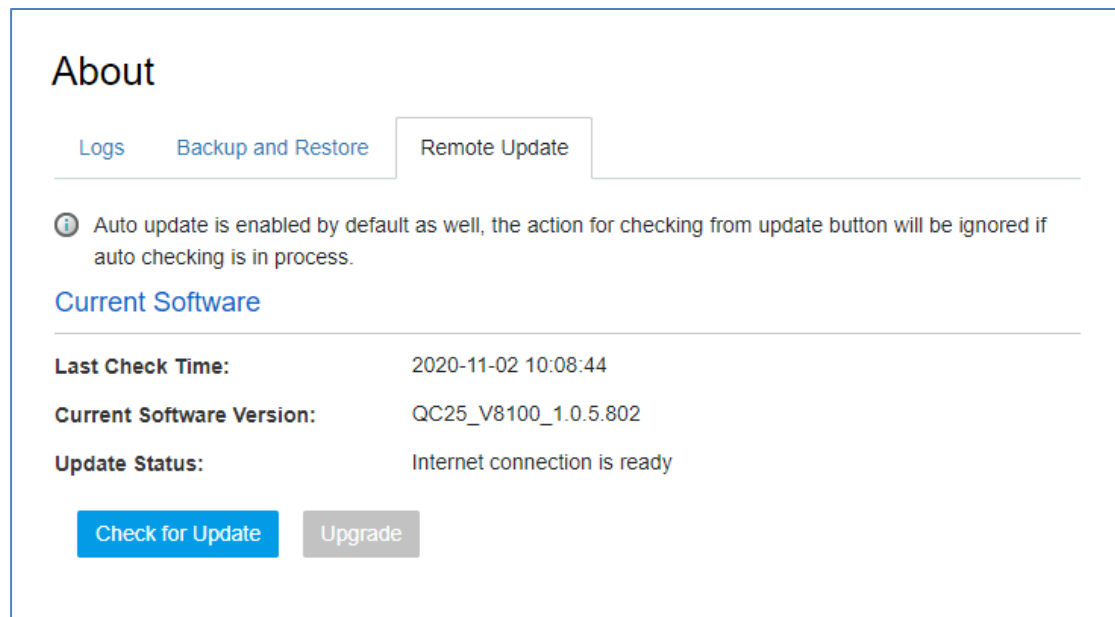

To avoid potential damage from power loss during a software upgrade, please ensure that you connect your V810 to a wall charger for external power prior to starting any software updates.

- **Check for Update:**

The “Check for Update” button is only active (blue button) every 6 hours. When active, you can click the “Check for Update” button to check for a new software version. If a new version is detected, the “Upgrade” button will become active (blue color).

- **Upgrade:**

If a software upgrade is available, click the active “Upgrade” button to launch the upgrade manually. Once the upgrade is completed, the device will reboot, and the new software version will be displayed.

4. ATRACS Cloud Remote Management

You can manage the device using the ATEL Cloud Remote Management Platform, ATRACS, by visiting <http://aags.a-tracs.com> or <https://aags.a-tracs.com>. Please refer to ATRACS User Manual for details.

5. Troubleshooting

When properly installed, the V810 is a highly reliable product. Most problems are caused by one of these issues:

1. Ethernet device was connected to incorrect ports.
2. Network coverage is unavailable due to coverage area, an account problem, or a network problem.

The following tips may help solve some common problems encountered while using your V810.

1. Make sure you are using the V810 in the correct geographic region (within the wireless coverage area of your service provider).
2. Ensure that your wireless coverage extends to your current location.
3. If you do not receive a strong wireless signal, try moving your V810 to a different location near a window.
4. Ensure that you have an active service plan.
5. Restarting your V810 can sometimes resolve the issues.

IMPORTANT! Before contacting customer care, be sure to restart both your V810 and any device to which it is currently connected.

6. Common Problems, FAQ's and Solutions

1. How do I perform a Power Reset on V810?

Your V810 can be in 2 different power modes; AC power only or NiMH battery installed.

To perform a Power Reset when the V810 is powered via the AC wall charger, either with a NiMH battery installed or not: Press and hold the power button for 5 seconds then release, the device will power off first and then power on automatically.

To perform a Power Reset when the V810 is powered via NiMH battery only: Press and hold the power button for 5 seconds then release, the device will power off. Then press the power button again and the device will power on.

Note: Unplug and disconnect all power source(s), then plug in and reconnect when performing a Power Reset. Unplug the wall charger and remove the battery for 10 seconds. Then, reinstall the battery and plug the charger back.

2. How do I perform a Device Reset using the RESET pin hole?

Using the RESET pin hole: Remove the back cover. Make sure your V810 is powered on. Use an unfolded paper clip, insert it into the RESET pin hole and push down for 3 seconds, then release. Your V810 will perform the reset and restart automatically.

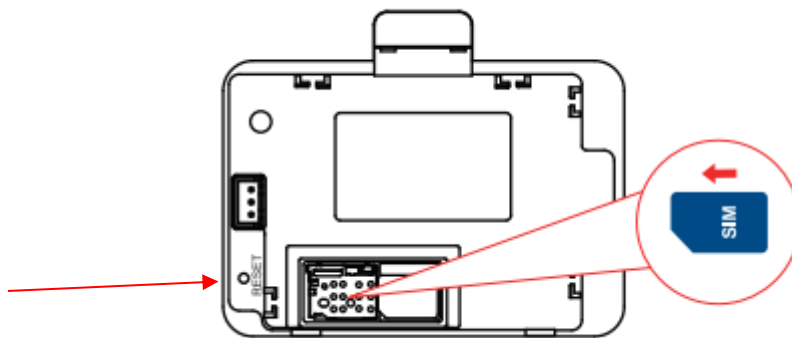

3. How long is the backup battery usage and standby time of the V810?

Usage time on backup batteries is approximately (up to) 5 hours and standby time is up to 8 hours. Actual values can vary with environmental conditions, connectivity, and other usage-related circumstances.

4. Why can't I connect to the internet?

If you cannot connect to the internet, try the following suggestions:

- a) Make sure you are connected to your V810 with the correct Hotspot Wi-Fi SSID and password.
- b) Make sure the SIM card is inserted properly in the spring-loaded SIM card slot.
- c) Contact your service provider to make sure your SIM subscription plan is active.

Note: A hotspot service plan may be required.

5. Where do I find the Hotspot Wi-Fi network name (SSID) and password?

The Hotspot Wi-Fi network name (SSID) and password can be found on your V810 LCD Display and on the device label (under the battery holder).

6. How do I perform a Factory Reset via the Direct Connect (WebGUI) Device Management Portal?

Connect to your V810 Hotspot Wi-Fi and then launch the Direct Connect Portal (<http://192.168.0.1>). Select About > Backup and Restore, click on Restore Factory Defaults.

7. Why can't I connect to Wi-Fi after changing the Wi-Fi password?

Your Wi-Fi devices save the previously used Wi-Fi names associated with the passwords used to access the Wi-Fi name. When you change the Wi-Fi password only for your V810 and keep the same Wi-Fi Name, the devices try to connect to your V810 using the Wi-Fi name and previous Wi-Fi password saved, causing Wi-Fi authentication error.

To resolve the issue, from your device Wi-Fi settings, try “Forget” your V810 Wi-Fi SSID from the network available list and re-connect again when the V810 SSID reappears.

8. Why can't I access the <https://192.168.0.1>?

If you can't access the Direct Connect Portal at <https://192.168.0.1>, check the following:

- a) Ensure the correct URL, <https://192.168.0.1>, is entered or try <http://192.168.0.1>
- b) Ensure your device is connected to your V810 Wi-Fi with the correct Wi-Fi name (SSID) and password.

The default password for the Direct Connect Portal can be found on the device label as well as the LCD screen display menu. If you have forgotten the password you created, you will need to do a factory reset to restore the default settings on your V810 by long pressing the RESET pinhole.

9. How can I manage my device?

There are two ways to manage your V810 device:

1. WebGUI (Direct Connect Management Portal)
 - a. Connect your PC and V810 device using Wi-Fi from the device, ethernet cable or USB-C cable.
 - b. Using your Web Browser, visit 192.168.0.1
 - c. Log in to the Direct Connect. Your username is 'admin' and the password can be found on the LCD display or on the device label on the bottom of the device (under the battery cover).
 - d. Once you've logged in, you can manage the device.
2. ATRACS (Cloud/Remote Device Management)
 - a. Using a PC with Internet access (not necessarily the internet provided by the device which is being managed), visit <http://aags.a-tracs.com> or <https://aags.a-tracs.com>
 - b. You need to create an account before you can login. For details, please refer to the ATRACS user manual (go to ATEL's website, www.ATEL-USA.com or contact ATEL Customer Support for additional information).

10. Where do I find the device Software (SW) version information?

The device SW version can be found on your V810 screen display menu by pressing the Power Key.

11. What do I do if I see a "No SIM" message on the device screen display?

If you see a "No SIM" message, please check the following:

- Make sure your SIM is inserted properly in the spring-loaded SIM card slot.
- Contact your service provider to make sure your SIM subscription plan is active.
- Check with your service provider on whether a SIM replacement is needed.

12. How do I fix my TV or gaming console or Security Camera if it cannot find the WIFI SSID while my phone and PC work on the WiFi?

Please follow the below steps to fix:

- a. Connect the PC to the V810 using its WiFi or Ethernet cable, or connect your iPhone or Android Phone to the V810 using its WiFi.
- b. Open any web browser and visit 192.168.0.1. If you can't open, please try another Web browser such as Safari or Chrome.
- c. Input the username: **admin**, the password can be found on the LCD display by pushing power button, or on the sticker at the bottom of the device, under the battery and the battery door.
- d. If using a PC, go to settings > WiFi settings > 802.11 Mode > select 802.11b/g/n (2.4GHz) > click "Save Changes". If using a phone, click the menu icon (three short lines) on the upper right corner, Settings > WiFi Settings > 802.11 Mode > select 802.11b/g/n (2.4GHz) > click "Save Changes".
- e. Try to search for the WiFi SSID on your TV or gaming console. If still can't find the WiFi SSID, restart the device by holding the power button down for 10 seconds. Then use TV or gaming console to search again.
- f. Your TV or gaming console should find the WIFI SSID now. Please note if you reset the device, repeat the above procedure again to configure.

13. How do I fix the device when it's stuck (it doesn't power on and doesn't charge)?

Please follow the below steps to fix:

- a. Unplug the USB cable from the wall charger.
- b. Open the battery door on the bottom of the V810.
- c. Unplug the battery from the device carefully. Please note that the use of tools (not provided by ATEL) to unplug the battery might cause damage to the device and void the warranty.

- d. Plug the battery back in and make sure it is plugged in all the way into the port. Plug the USB cable and wall charger back into the wall outlet.
- e. The device should power on once the wall charger is connected.
- f. If the device is on battery only without the wall charger, please press and hold the power button until the V810 powers on.

7.Regulatory Statements

FCC Equipment Authorization ID: XYO-V810

This device complies with Part 15 of the FCC Rules. Operation is subject to the following two conditions:

- This device may not cause harmful interference.
- This device must accept any interference received, including interference that may cause undesired operation.

This equipment has been tested and found to comply with the limits for a Class B digital device, pursuant to part 15 of the FCC Rules. These limits are designed to provide reasonable protection against harmful interference in a residential installation.

FCC CAUTION: Any changes or modification not expressly approved by ATEL, the party responsible for compliance could void the user's authority to operate this equipment.

This equipment generates uses and can radiate radio frequency energy and, if not installed and used in accordance with the instructions, may cause harmful interference to radio communications. However, there is no guarantee that interference will not occur in a particular installation. If this equipment does cause harmful interference to radio or television reception, which can be determined by turning the equipment off and on, the user is encouraged to try to correct the interference by one or more of the following measures:

- Reorient or relocate the receiving antenna.
- Increase the separation between the equipment and receiver.
- Connect the equipment into an outlet on a circuit different from that to which the receiver is connected.
- Consult the dealer or an experienced radio/TV technician for help.

RF Exposure Warning Statements:

The antenna(s) used for this transmitter must be installed to provide a separation distance of at least 20 cm from all persons during the normal operations.

NOTE: The Radio Frequency (RF) emitter installed in your modem must not be located or operated in conjunction with any other antenna or transmitter, unless specifically authorized by ATEL.

8. Safety Hazards

Follow Safety Guidelines

Always follow the applicable rules and regulations in the area in which you are using your device. Turn your device off in areas where its use is not allowed or when its use may cause interference or other problems. Note that this type of device should be placed at least 10 ft from work area(s).

Electronic Devices

Most modern electronic equipment is shielded from radio frequency (RF) signals. However, inadequately shielded electronic equipment may be affected by the RF signals generated by your device.

Medical and Life Support Equipment

Do not use your device in healthcare facilities or where medical life support equipment is located as such equipment could be affected by your device's external RF signals.

Pacemakers

- It is recommended to maintain a minimum separation of six inches between a RF device and a pacemaker in order to avoid potential interference with the pacemaker.
- Persons with pacemakers should always follow these guidelines:
- Always keep the device at least six inches away from a pacemaker when the device is turned on.
- Place your device on the opposite side of your body where your pacemaker is implanted in order to add extra distance between the pacemaker and your device.
- Avoid placing a device that is on next to a pacemaker (e.g., do not carry your device in a shirt or jacket pocket that is located directly over the pacemaker).
- If you are concerned or suspect for any reason that interference is taking place with your pacemaker, turn your device OFF immediately.

Hearing Devices

When some wireless devices are used with certain hearing devices (including hearing aids and cochlear implants) users may detect a noise which may interfere with the effectiveness of the hearing device.

Use of Your Device while Operating a Vehicle

Please consult the manufacturer of any electronic equipment that has been installed in your vehicle as RF signals may affect electronic systems in motor vehicles.

Please do not operate your device while driving a vehicle. This may cause a severe distraction, and, in some areas, it is against the law.

Use of Your Device on an Aircraft

Don't use your device during flight, it may violate FAA regulations. Because your device may interfere with onboard electronic equipment, always follow the instructions of the airline personnel and turn your device OFF.

Blasting Areas

In order to avoid interfering with blasting operations, your device should be turned OFF when in a blasting area or in an area with posted signs indicating that people in the area must turn off two-way radios. Please obey all signs and instructions when you are in and around a blasting area.

Proper Battery & Adapter Use and Disposal

- Do not disassemble or open, crush, bend or deform, puncture or shred.
- Do not modify or remanufacture, attempt to insert foreign objects into the battery, immerse or expose to water or other liquids, expose to fire, explosion or another hazard.
- Only use the battery for the system for which it is specified.
- Do not short circuit a battery or allow metallic conductive objects to contact battery terminals.
- Replace the battery only with another battery that has been qualified with the system per this standard. Use of an unqualified battery may present a risk of fire, explosion, leakage or another hazard. Only authorized service providers shall replace the battery.
- Promptly dispose of used batteries in accordance with local regulations.
- Battery usage by children should be supervised.
- Avoid dropping the battery. If the battery is dropped, especially on a hard surface, and the user suspects damage, take it to a service center for inspection.
- Improper battery use may result in a fire, explosion or another hazard.

Disclaimer:

Certain variations may be present between the device and user manual description depending on software release or specific network services. ATEL shall not be held legally responsible for such deviations, if any, nor for their potential consequences.

Limited Warranty:

The full ATEL USA Warranty Policy can be found at www.atel-usa.com/warranty. On this page you can "Start a Warranty Claim", "Check on an Existing Claim" and read the Warranty Policy by clicking on "ATEL's Warranty Policy". Please follow all warranty instructions available and if you have any questions contact us at support@atel-usa.com. Note that some actions such as, but not limited to, using sharp objects to open the device, may void the warranty.

Trademark. ATEL name and logo are trademarks owned and protected by Asiatelco Technologies, Inc. © 2023 Asiatelco Technologies, Inc. All rights reserved.

ATEL V810 Series
V810A and V810AD Data User Manual
V6.9, July 17, 2023